



South Carolina
Department of Transportation

Request for Proposals



US 21 OVER HARBOR RIVER
BRIDGE REPLACEMENT

Design-Build Project

Project ID P026862

Beaufort County

April 27, 2017

US 21 Over Harbor River Bridge Replacement

Beaufort County, South Carolina

A Design-Build Project

Project ID P026862

INDEX

Request for Proposals Instructions

Attachment A: Agreement

- Exhibit 1. Cost Proposal Bid Form
- Exhibit 2. Schedule of Values
- Exhibit 3. Scope of Work
- Exhibit 4. Project Design Criteria
 - 4a. Roadway Design Criteria
 - 4b. Structures Design Criteria
 - 4c. Pavement Design Criteria
 - 4d. Traffic Design Criteria
 - Part 1 – Signing and Pavement Markings
 - Part 2 – Work Zone Traffic Control
 - 4e. Hydraulic Design Criteria
 - 4f. Geotechnical Design Criteria
 - 4g. Environmental Design Criteria
 - 4z. Project Design Deliverables
- Exhibit 5. Special Provisions and Contract Requirements

Attachment B: Supplemental Project Design Criteria

Attachment C: Project Information Package

REQUEST FOR PROPOSALS

TABLE OF CONTENTS

1. PURPOSE OF REQUEST FOR PROPOSALS	1
2. PROJECT OVERVIEW	1
2.1 PROJECT DESCRIPTION	1
2.2 PROJECT INFORMATION.....	1
2.3 SCDOT POINT OF CONTACT	2
2.4 RFP COMMITTAL	2
2.5 NEPA DOCUMENT/PERMIT	2
2.6 SCHEDULE.....	3
3. GENERAL INSTRUCTIONS	3
3.1 DESIGN-BUILD PROCUREMENT METHOD	3
3.2 RFP FOR INDUSTRY REVIEW	4
3.3 QUESTIONS, CLARIFICATIONS, AND OPEN-FORUM MEETING	4
3.4 FINAL RFP	4
3.5 NON-CONFIDENTIAL QUESTIONS AND ADDITIONAL OPEN-FORUM MEETINGS	5
3.6 CONFIDENTIAL QUESTIONS	5
3.7 PRELIMINARY ALTERNATIVE TECHNICAL CONCEPTS	6
3.8 FORMAL ALTERNATIVE TECHNICAL CONCEPTS	8
3.9 STIPENDS.....	12
4. PROPOSAL DEVELOPMENT AND SUBMITTAL	13
4.1 TECHNICAL PROPOSAL.....	13
4.2 COST PROPOSAL	16
4.3 PROPOSAL SUBMITTAL	16
4.4 CONFIDENTIALITY OF PROPOSALS.....	17
4.5 NON-COLLUSION AND EQUAL EMPLOYMENT OPPORTUNITY CERTIFICATION	17
5. EVALUATION OF PROPOSALS.....	18
5.1 EVALUATION COMMITTEE.....	18
5.2 PROPOSAL REVIEW.....	18
5.3 TECHNICAL EVALUATION	18
5.4 PRESENTATIONS.....	19
5.5 CLARIFICATIONS	19
5.6 OPENING OF COST PROPOSALS/BID OPENING MEETING.....	19
5.7 DISCUSSIONS.....	20
5.8 BEST AND FINAL OFFER	21
5.9 TOTAL ADJUSTED BID DETERMINATION.....	21
5.10 PROTEST	22
6. SELECTION OF CONTRACTOR	23
7. GENERAL INFORMATION	24

8. MILESTONE SCHEDULE.....26
9. COST PROPOSAL BID FORM27
10. NON-COLLUSION CERTIFICATION.....28
11. EQUAL EMPLOYMENT OPPORTUNITY CERTIFICATION.....29
12. STIPEND ACKNOWLEDGEMENT FORM30
13. STIPEND AGREEMENT31

1. PURPOSE OF REQUEST FOR PROPOSALS

The purpose of this Request for Proposals (RFP) is to select a Proposer to perform the Project services described in this RFP. SCDOT desires that this Project be constructed in a very efficient and timely manner. The proposed Project services are hereinafter referred to as the “Project”. “Proposer,” as used here, includes a firm or firms, consortia, partnerships, joint ventures, and other legal entities, which have been requested by South Carolina Department of Transportation (SCDOT) to submit a Proposal in response to this RFP. The Proposer shall become the Contractor if awarded the Contract.

It is not the intention of SCDOT to receive complete detailed Project analysis and design prior to the selection of a Proposer and the later execution of an agreement. Rather, the response to this RFP shall provide sufficient information to be evaluated by SCDOT to determine if the Proposal is in accordance with the specified process and criteria. The Proposal shall be specific enough on assumptions used in its preparation so as to provide the basis for determining a final agreement.

The information obtained under this RFP will become the property of SCDOT without restriction or limitation on its use. With the exception of Alternative Technical Concepts (ATCs), SCDOT shall have unrestricted authority to publish, disclose, distribute, or otherwise use in whole or in part any reports, data, or other materials prepared under this RFP. SCDOT shall retain ownership of all plans, specifications, and related documents.

2. PROJECT OVERVIEW

2.1 Project Description

The SCDOT proposes to construct a new high-level fixed-span bridge and to remove the existing swing-span bridge along US 21 (Sea Island Parkway) over the Harbor River in Beaufort County. The bridge provides the only means for vehicular transportation from the mainland to Harbor Island, Hunting Island, and Fripp Island. The project is needed because the existing bridge is structurally deficient and functionally obsolete.

SCDOT intends to enter into a contract for services as detailed in the Agreement and Agreement Exhibits. The Proposer shall be responsible for meeting all Project requirements, specifications, and other applicable criteria as set forth in “Attachments A and B”. Attachment B is located on the SCDOT Design-Build website at http://www.scdot.org/doing/us21_HarborRiver.aspx. It is the Proposer’s responsibility to check the website regularly for updates, modifications and additional documentation pertaining to this procurement in Attachment B.

2.2 Project Information

Project Information, containing electronic files applicable to the Project, will be posted on the SCDOT Design-Build website. The Project Information Package will include

information describing the work performed or obtained by SCDOT prior to entering into the contract for the Project. The Project Information Package is attached to these RFP Instructions as “Attachment C”. “Attachment C” may contain additional information not provided at the RFQ stage. Data, reports, plans, electronic files, and any other items supplied in Attachment C which is posted on the SCDOT Design-Build website are for information only. SCDOT shall not be liable for the reliability or accuracy of the information contained therein. It is the Proposer’s responsibility to check the website regularly for updates, modifications and additional documentation pertaining to this procurement in Attachment C.

Proposers are encouraged to visit the Project site and to make any additional subsurface explorations or soil tests that the Proposer may desire for purposes of preparing the Proposal. The Proposer shall obtain any permits or permissions required prior to any additional subsurface exploration.

2.3 SCDOT Point of Contact

Ms. Carmen Wright is sole point of contact (POC) and addressee for receiving all communications about the Project with a copy to Ms. Barbara Wessinger, Alternate POC. The Alternate POC has been identified in the event of the unavailability of the POC but is not intended as a substitute for the POC. No contact is allowed with any SCDOT personnel concerning this Project except for questions of an administrative or contractual nature that shall be submitted in writing to the attention of the POC (email is acceptable) with a copy to the Alternate POC. This restriction is in effect until the contract has been awarded. Any Proposer engaging in prohibited communications may be disqualified at the sole discretion of SCDOT. Written inquiries from the Proposer’s POC (as identified in the Proposer’s SOQ) shall be sent to:

Mail Delivery: Ms. Carmen Wright (Ms. Barbara Wessinger)
Office of Project Delivery (Office of Chief Counsel)
South Carolina Department of Transportation
955 Park Street, Room 101 (Room 302)
Columbia, South Carolina 29202-0191

E-mail: WrightCL@scdot.org (WessingeBM@scdot.org)

2.4 RFP Committal

The submittal of a Proposal in response to this RFP shall constitute the Proposer’s agreement to enter into a contract with SCDOT for the completion of the Project under the terms set forth in the Agreement and Agreement Exhibits attached hereto as “Attachment A”.

2.5 NEPA Document/Permit

SCDOT prepared an Environmental Assessment (EA) and Finding of No Significant Impact (FONSI) for the project. SCDOT obtained the FONSI on December 22, 2016.

These documents are available in Attachment B. The Proposer must comply with the NEPA determinations and all environmental commitments.

SCDOT obtained no permits for this project. The selected Proposer shall be responsible for obtaining all permits.

2.6 Schedule

Time is of the essence. In accordance with the Agreement, Article IV, the project shall be substantially complete on, or before, November 12, 2021.

3. GENERAL INSTRUCTIONS

3.1 Design-Build Procurement Method

For this Design-Build Project, SCDOT chose the two-phased procurement method. Phase 1, which identified a short-list of qualified Proposers, is complete.

In Phase 2, SCDOT will invite each of the short-listed Proposers to submit their Proposals for completion of the Project. After evaluation of the Proposals, SCDOT plans to award and execute a contract with a single Proposer. Phase 2 includes the following steps:

1. SCDOT releases RFP for Industry Review
2. SCDOT holds Open-Forum Meeting with Proposers to clarify/revise RFP
3. SCDOT releases Final RFP
4. Proposers submit Preliminary Alternative Technical Concepts (ATC) and Confidential Questions
5. SCDOT conducts Confidential One-on-One Meetings with Proposers to discuss Preliminary ATCs and Confidential Questions
6. SCDOT accepts Non-confidential Questions and conducts Open-Forum Meetings with all Proposers, if necessary
7. Proposers submit Formal ATCs and any additional Confidential Questions
8. SCDOT conducts Confidential One-on-One Meetings with Proposers to discuss Formal ATCs and additional Confidential Questions, if necessary
9. SCDOT accepts Non-confidential Questions and conducts Open-Forum Meetings with all Proposers, if necessary
10. SCDOT approves/disapproves ATCs

11. Proposers submit Proposals
12. SCDOT evaluates Proposals
13. Proposers provide Presentations, if necessary
14. SCDOT selects a Contractor

These steps will be carried out following the Milestone Schedule in Section 8. The following paragraphs provide information detailing various steps of the process.

3.2 RFP for Industry Review

The intent of the RFP for Industry Review is to identify those areas of the RFP that may be in conflict with each other and to point out and clarify mistakes or ambiguities in the RFP.

3.3 Questions, Clarifications, and Open-Forum Meeting

Once the RFP for Industry Review is issued, the Proposers may submit questions and seek clarification relating to the RFP. An Open-Forum Meeting with all Proposers present will be held on the date provided in the Milestone Schedule to facilitate this purpose. The purpose of this meeting will be limited to editing the RFP for Industry Review. Non-confidential questions will be accepted via electronic upload to ProjectWise on the dates provided in the Milestone Schedule. Proposers shall submit their questions or comments using the Questions Submittal Form which can be downloaded from the SCDOT Design-Build website under the SCDOT Design-Build Documents and Standard Forms Section.

http://www.scdot.org/doing/constructionLetting_DesignBuild.aspx.

SCDOT reserves the right to accept or not accept non-confidential questions received after the milestone deadline. SCDOT will review all questions and/or requests for clarification received and, if it deems appropriate, in its sole discretion, may incorporate them in the Final RFP. SCDOT will make every attempt to provide verbal answers during the Open-Forum Meeting to the questions received. SCDOT's verbal answers to Proposers' questions are for general information only, are non-binding, do not constitute legal or other advice, and do not amend or form part of the Final RFP. Nothing discussed at this meeting shall change the requirements of the Final RFP.

3.4 Final RFP

After completion of the Questions, Clarifications, and Open-Forum Meeting stage, SCDOT may incorporate the Proposers' comments into the RFP, and a Final RFP will be issued. Items that are revised, inserted, or deleted will be highlighted in the Final RFP. In addition to releasing a highlighted version of the Final RFP, SCDOT will also

concurrently release a clean version of the Final RFP where all revisions, insertions, and deletions are not highlighted. It is this clean version of the Final RFP that will be utilized if any future Addendums are required.

3.5 Non-confidential Questions and additional Open-Forum Meetings

Once the Final RFP is issued, SCDOT will allow Proposers to submit non-confidential questions to request clarification and point out mistakes or ambiguities in the RFP. SCDOT will review all non-confidential questions and/or requests for clarification received and, if it deems appropriate, in its sole discretion, may incorporate them in the RFP through an Addendum.

SCDOT may or may not verbally respond to the non-confidential questions received. If responses are provided, it will be verbally through an Open-Forum Meeting where all Proposers will be invited to attend. This meeting may be conducted via conference call. A Proposers' failure to attend this meeting will not relieve the Proposer of the responsibility for estimating properly the difficulty and cost of successfully performing the work, or for proceeding to successfully perform the work without additional expense to SCDOT. SCDOT's verbal responses to Proposers' questions are for general information only, are non-binding, do not constitute legal or other advice, and do not amend or form part of the Final RFP. Written responses to any questions will not be provided. Nothing discussed during the Open-Forum Meetings shall change the requirements in the RFP.

Non-confidential questions will be accepted via electronic upload to ProjectWise on the dates provided in the Milestone Schedule. Written questions submitted outside of these dates may not be accepted. If deemed necessary by SCDOT, Open-Forum Meetings will be held within 10 business days following receipt of non-confidential questions. Proposers must use the Question Submittal Form that is provided on the SCDOT Design-Build website under the SCDOT Design-Build Documents and Standard Forms Section.

http://www.scdot.org/doing/constructionLetting_DesignBuild.aspx.

3.6 Confidential Questions

Once the Final RFP is issued, SCDOT will allow Proposers to submit confidential questions to provide the Proposer an opportunity to confidentially discuss the contents of his/her Proposal with SCDOT personnel. SCDOT will determine/confirm if questions submitted are considered confidential, as identified by the Contractor on the Question Submittal Form. If more than one confidential question on the same topic has been received from multiple Proposers, SCDOT has the right to revise the RFP to include that concept as an addendum to the RFP. If submitted confidential questions are determined to be of non-confidential nature or identify an error or omission in the RFP, SCDOT, if it deems appropriate, in its sole discretion, may incorporate them in the RFP through an Addendum.

SCDOT may or may not verbally respond to the submitted confidential questions during the Confidential Preliminary ATC Meeting and/or any Confidential One-on-One Formal ATC Meetings. SCDOT's verbal responses to Proposers' questions are for general information only, are non-binding, do not constitute legal or other advice, and do not amend or form part of the Final RFP. Written responses to any questions will not be provided. Nothing discussed during the Confidential Preliminary ATC Meeting and/or any Confidential One-on-One Formal ATC Meetings shall change the requirements in the RFP.

Confidential questions will be accepted via electronic upload to ProjectWise on the dates identified in the Milestone Schedule for submittal of Preliminary and Formal ATCs. Written questions submitted outside of these dates may not be accepted.

Confidential questions received on the dates prior to the Confidential Preliminary ATC Meetings with Proposers may be discussed at that meeting. For confidential questions received on the allowable date(s) after the Confidential Preliminary ATC Meeting, verbal answers may be answered with a Confidential One-on-One Questions Meeting/conference call which may be held within 10 business days following receipt of the confidential questions. Proposers must use the Question Submittal Form that is provided on the SCDOT Design-Build website under the SCDOT Design-Build Documents and Standard Forms Section.

http://www.scdot.org/doing/constructionLetting_DesignBuild.aspx.

3.7 Preliminary Alternative Technical Concepts

An ATC is a confidential request by a Proposer to modify a contract requirement, specifically for that Proposer, prior to the Proposal due date. Requests for contract modifications that may qualify as ATC's may include, but not be limited to, changes in design criteria, changes in alignments or location of facilities, changes to review and submittal processes, change in material or structure types, change in interchange type, etc. The ATC process provides an opportunity for design-build Proposals to promote innovation, find the best solutions, and to maintain flexibility in the procurement process. ATCs are evaluated for approval or disapproval by SCDOT within the deadline set forth in the Milestone Schedule. In order to be approved, an ATC must be deemed, in SCDOT's sole discretion, to provide a Project that is equal or better in quality or effect on an overall basis than the Project would be without the proposed ATC. Concepts that simply delete scope, lower performance requirements, lower standards, conflict with environmental commitments, or reduce contract requirements are not acceptable as ATCs. SCDOT reserves the right, in its sole discretion, to reject any ATC. No ATC shall be included in the Proposal unless approved by SCDOT in writing prior to the Proposal submission deadline.

3.7.1 Submittal of Preliminary ATCs

Preliminary concepts are intended to be an informal inquiry by the Proposer to explore a concept and a quick method by SCDOT to review and comment on potential development of ATCs prior to investment of time and resources by the Proposer. Preliminary concepts shall present a Description, Deviations, and a range of Costs, as further described in Section 3.8.1. Other items identified in Section 3.8.1 can be provided, but are not required. The amount of information provided shall be constrained to the boxes provided in the Preliminary ATC Submittal Form. SCDOT will allow one single letter sized attachment (8.5" x 11") for detailed drawings or sketches. Submission of preliminary concepts does not change or extend the submission deadline of Formal ATCs.

Proposers shall be limited to one package of preliminary concepts and the total number of preliminary concepts shall not exceed 20. If more than one preliminary concept on the same topic has been received from multiple Proposers, SCDOT has the right to revise the RFP to include that concept as an addendum to the RFP.

All preliminary ATCs shall be submitted electronically by uploading to ProjectWise in a single zip folder with each file name using the following format: PATCSummary_ProposerName or PATCNumber_ProposerName. The Proposers shall use the ATC Summary Form and the Preliminary ATC Submittal Form, which can be downloaded from the SCDOT Design-Build website under the SCDOT Design-Build Documents and Standard Forms Section.

http://www.scdot.org/doing/constructionLetting_DesignBuild.aspx.

The Proposer shall submit Preliminary ATCs for review in accordance with the Milestone Schedule. All Preliminary ATC information being exchanged between Proposers and SCDOT shall occur only on the specific dates shown, unless otherwise directed by the SCDOT POC.

3.7.2 Confidential Preliminary ATC Meeting

SCDOT will offer Confidential Preliminary ATC Meetings at the request of the Proposers. Proposers shall request a meeting in writing (email is acceptable) addressed to the SCDOT POC with a copy to the alternate POC by the date specified in the Milestones Schedule. SCDOT will reserve 1.5 hours of meeting time for each Proposer that requests a meeting, and SCDOT will give time of day preference in the order that requests are received. The purpose of this meeting is to provide the Proposer with the opportunity to confidentially discuss the preliminary ATCs and questions with SCDOT personnel. SCDOT may answer questions at the meeting verbally. Verbal responses are for information only and are not binding. Nothing discussed at this meeting shall change the requirements in the RFP.

3.7.3 Responses to Preliminary ATCs

SCDOT will provide a response to the Proposer in accordance with the Milestone Schedule. SCDOT responses will be “Favorable,” “Not Favorable,” “Addendum,” or “Not an ATC.” If additional clarification is needed after the Preliminary ATC Meeting, Proposers are responsible for sending the clarification as soon as possible so that SCDOT has an opportunity to assess the benefits of the concepts before providing a response in accordance with the Milestone Schedule. A favorable response by SCDOT in no way guarantees that the concept will become an approved formal ATC. The favorable response may be subject to conditions.

3.8 Formal Alternative Technical Concepts

3.8.1 Submittal of Formal ATCs

Each formal ATC submittal shall include the following.

- **Description:** A detailed description and schematic drawings of the configuration of the ATC or other appropriate descriptive information (including, if appropriate, specifications, construction tolerances, special provisions, proposed bridge types, product details, and a traffic operational analysis)
- **Usage:** Locations where and an explanation of how the ATC would be used on the Project
- **Deviations:** List all references to any requirements of the RFP or to any requirements of the Contract Documents that are inconsistent with the proposed ATC. Include an explanation of the nature of the proposed deviation and a request for approval of such deviations or a determination that the ATC is consistent with the requirements of the RFP
- **Justification:** Justify use of the ATC and why the deviations from the requirements of the RFP should be allowed
- **Schedule:** Proposed changes to the Project schedule if applicable
- **Impacts:** Identify potential impacts on vehicular traffic, safety, community, utilities, right of way, and the environment
- **History:** A detailed description of other projects where the ATC has been used under comparable circumstances, the success of such usage, and names and telephone numbers of project owners that can confirm such statements
- **Risks:** A description of added risks to SCDOT and other persons associated with implementing the ATC
- **Costs:** An estimate of the impact of the ATC on the Proposal Price and the ATC implementation costs to SCDOT, FHWA, Contractor, or other person during construction, maintenance and operations
- **Quality:** A description of how the ATC is equal or better in quality and performance than the requirements of the RFP

- **Operations & Maintenance:** Any changes in operation or maintenance requirements associated with the ATC.

The technical response to each item outlined above shall be provided in the Formal ATC Submittal Form. Text submissions shall be limited to the form and shall not be provided as attachments. Only drawing details, plan sheets, charts, tables, graphs, and supporting reports/analyses can be provided as an attachment to the Formal ATC Submittal Form.

A maximum number of 10 formal ATCs may be submitted to SCDOT by the Proposer for consideration.

All formal ATCs shall be submitted electronically by uploading to ProjectWise in a single zip folder with each file name using the following format: FATCSummary_ProposerName or FATCNumber_ProposerName. The Proposers shall use the ATC Summary Form and the Formal ATC Submittal Form, which can be downloaded from the SCDOT Design-Build website under the SCDOT Design-Build Documents and Standard Forms Section.

http://www.scdot.org/doing/constructionLetting_DesignBuild.aspx.

The Proposer shall submit formal ATCs in accordance with the Milestone Schedule. All information being exchanged between Proposers and SCDOT shall occur only on the specific dates shown, unless otherwise directed by the SCDOT POC.

3.8.2 Review of Formal ATCs

Review of formal ATCs shall be in accordance with the information and Milestone Schedule provided herein.

- a. **Initial Review:** Upon completion of the initial review, SCDOT will make a final determination in accordance with Section 3.8.3, request more information, or provide a conditional response.
- b. **More Information Needed:** SCDOT may submit written questions to the Proposer as outlined in the Milestone Schedule, and/or request a one-on-one meeting in order to better understand the details of the formal ATC. Additionally, for questions related to minor clarifications, SCDOT may submit written questions to the Proposer at any time during the initial review or any subsequent review. Proposers will then have the opportunity to resubmit according to the Milestone Schedule.
- c. **One-on-One Meetings:** Confidential One-on-One Formal ATC meeting(s) may be scheduled to fully understand the details of any formal ATCs. These meetings will be restricted to those persons involved in the review of the

formal ATC and limited to discussions of the Proposer's formal ATC approach and any outstanding confidential questions. The purpose of this meeting is to discuss proposed changes, answer questions, and other relevant issues. Verbal responses are for information only and are not binding. Nothing stated at any formal ATC meeting(s) will modify the RFP or Contract Documents. SCDOT reserves the right to disclose to all Proposers any issues raised during the ATC meeting(s) in an addendum. However, SCDOT will not disclose any information pertaining to an individual Proposer's ATCs or other technical concepts to other Proposers.

- d. Conditional Response by SCDOT: If the SCDOT states a formal ATC is not approved in its present form, it may be reconsidered for approval upon satisfaction, in SCDOT's sole discretion, of certain identified conditions that must be met or certain clarifications or modifications that must be made by Proposer. The Proposer shall not have the right to incorporate this formal ATC into the Proposal unless and until the formal ATC has been resubmitted in accordance with the Milestone Schedule, with the conditions, clarification and modifications satisfied, and SCDOT has made a final determination.
- e. No Response from SCDOT: If the Proposer does not receive correspondence from SCDOT in accordance with the Milestone Schedule, the formal ATC is deemed rejected by SCDOT, unless written notification to extend this period is given by SCDOT.

3.8.3 Final Determination of SCDOT

SCDOT will make one of the following written determinations with respect to each properly submitted ATC:

- a. The ATC is approved.
- b. The ATC is not approved.
- c. The submittal does not qualify as an ATC but appears eligible to be included in the Proposal without an ATC (i.e., the concept appears to conform to the RFP and to be consistent with other contract requirements).
- d. The ATC is deemed to take advantage of an error or omission in the RFP, or other documents incorporated into the contract by reference, the ATC will not be considered, and the RFP will be revised to correct the error or omission.
- e. More than one formal ATC has been received on the same topic and SCDOT has elected to exercise its right to issue an addendum to the RFP to include that topic.

Once an ATC has been approved, only the entire ATC is eligible for inclusion into the Proposal. The inclusion of partial ATCs into a Proposal is not allowed, unless the individual ATCs have received separate approval by SCDOT.

Each Proposer, by submittal of its Proposal, acknowledges that the opportunity to submit ATCs was offered to all Proposers, and waives any right to object to SCDOT's determinations regarding acceptability of ATCs.

3.8.4 Incorporation into Proposal

A Proposer has the option to include any or all approved ATCs in its Proposal. If SCDOT responded to an ATC by identifying conditions for approval, Proposer may not incorporate such ATC into the Proposal unless all conditions have been met. Copies of SCDOT's ATC approvals, which shall include the ATC Summary Form for each incorporated ATC, shall be included in the Technical Proposal appendices. Proposals with or without ATCs will be evaluated against the same technical evaluation factors set forth in the Evaluation of Proposals section, and the inclusion of an ATC, including an ATC that provides technical enhancements, may or may not receive a higher technical rating. SCDOT approval of an ATC shall not be considered a guaranty that the Proposal incorporating the ATC will be selected. SCDOT's rejection of an ATC will not entitle the Proposer to an extension of the Proposal submission deadline on the Milestone Schedule or claim for additional costs or delays, including development costs, loss of anticipated profits, or increased material or labor costs. The Total Cost to Complete shown in the Cost Proposal shall reflect any incorporated approved ATCs. Except for incorporating approved ATCs, the Proposal may not otherwise contain exceptions to or deviations from the requirements of the RFP.

3.8.5 Value Engineering

An approved ATC that is not incorporated into the Proposal will not be considered a pre-approved value engineering change.

3.8.6 Abandonment of ATC by Proposer

If the approved ATC is abandoned by the Proposer, is unable to obtain required approvals, is otherwise proved to be infeasible, or fails to be constructed for any reason, the successful Proposer is obligated and required to complete the Project utilizing the original RFP requirements at the awarded cost, and shall be responsible for any redesign costs.

3.8.7 SCDOT's use of Concepts Contained in an ATC

SCDOT expressly reserves the right to adopt and use any ATC, approved or disapproved, by the successful Proposer on this contract or other contracts

administered by SCDOT. By submitting a Proposal, all unsuccessful Proposers acknowledge that upon acceptance of the designated stipend, all approved or disapproved ATCs may be included in this contract or other contracts administered by SCDOT and shall become the property of SCDOT without restriction on use. Prior to contract execution, limited negotiations may be conducted as necessary to incorporate the ideas and concepts from unsuccessful Proposers, provided a stipend is accepted by the unsuccessful Proposer.

3.8.8 Proposer Obligations

The successful Proposer, in addition to performing all other requirements of the Contract Documents, shall:

- a. Obtain and pay the cost of obtaining all required approvals including approvals required to implement any approved ATC(s) incorporated into the Contract Documents;
- b. Obtain and pay the cost of obtaining any third party approvals required to implement any approved ATC(s) incorporated into the Contract Documents; and
- c. Unless otherwise noted in the Contract, be responsible for all costs and/or delays of any nature associated with the implementation of any approved ATC incorporated into the Contract Documents.
- d. Be solely responsible for reviewing the RFP and determining if the ATC deviates from the revised requirements if SCDOT revises the RFP after a formal ATC has been approved. The Proposer must submit a request for approval of all additional variances required within five (5) business days of receipt of the RFP addendum.

3.9 Stipends

By submitting a Proposal in response to the RFP, the Proposer acknowledges the following:

1. It is the intent of SCDOT to award a stipend of \$100,000 to each responsible and responsive Proposer subject to the terms of the Stipend Agreement set forth in Section 13 of the RFP Instructions.
2. If Proposer elects to receive a stipend, the Stipend Acknowledgement form and Stipend Agreement shall be signed by Proposer and submitted as part of the unsealed Technical Proposal. The Stipend Agreement will not count against the specified page limit.

4. PROPOSAL DEVELOPMENT AND SUBMITTAL

Proposals must be submitted separately in two parts, a Technical Proposal and a Cost Proposal. Required forms, conceptual plans, and approved ATCs used in preparing the Proposer's Cost Proposal shall also be incorporated in the Technical Proposal as Appendices. If a Proposer does not, at a minimum, submit a Technical Proposal Narrative and Technical Proposal Conceptual Plans, the submittal will be considered non-responsive and returned without further review/evaluation. Any concepts that conflict with the RFP specifications discovered during the evaluations or after award of the Project, and which are not approved as an ATC, shall not prevail over RFP specifications.

4.1 Technical Proposal

The Technical Proposal Narrative shall contain no more than ten pages, excluding any plans, signed forms, and appendices. Any Conceptual Plans developed by the Proposer to accompany the Proposer's Narrative shall be incorporated in the Technical Proposal as Appendices.

The Technical Proposal Narrative shall be on single sided 8.5"x11" letter sized paper, with minimum twelve-point Times New Roman font and double line spacing for text. Any Conceptual Plans shall be provided in black and white on single sided 11"x17" paper unless otherwise noted herein.

The Technical Proposal Appendices shall include Conceptual Plans, maintenance of traffic documents (if required), required forms, and approved ATCs being incorporated into the Proposer's Cost Proposal. If RFP addendums are issued, the Technical Proposal Appendices shall include the Notices of Receipt of Addendum.

In addition to submittal of required appendices documents, to be responsive, the Technical Proposal shall include at a minimum a narrative describing the Project Delivery and Approach.

In the Technical Proposal Narrative, Proposers shall respond to the following items and shall develop the narrative in the following sequence:

1. Describe the Project Delivery & Approach by discussing/providing the following. (35 points).
 - a. Identify the Teams approach to delivering the project including the sequence of construction, material and equipment staging, and approach to working in the marine environment. Describe methods for material delivery and storage recognizing the existing bridge is load restricted. Discuss the project schedule and approach to delivering the project in a timely manner.
 - b. Describe the proposed design submittal process and include a chart showing anticipated deliverables in sequence that will allow SCDOT to conduct efficient and complete reviews. Include discussion of how the design review process is

related to any proposed project phasing/segmentation. Dates do not need to be included in the chart showing anticipated deliverables.

- c. Describe the proposed approach for working around and protecting an existing load restricted swing-span bridge which must remain operational until demolition. Describe plan to shift traffic from the existing bridge to the new bridge including the Team's plans for demolition of the swing-span bridge once traffic is shifted to the new structure.
- d. Describe the proposed approach for minimization, avoidance, and mitigation of environmental impacts. Describe the plan for obtaining permits and compliance with environmental commitments.
- e. Describe the proposed approach for design and construction of foundation elements, and the design and construction of the roadway and bridge embankments as it pertains to meeting performance limits for service and extreme event limit states.

2. Innovation and Added Value (5 Points).

- a. Describe the innovation and additional quality shown or discussed in the project delivery and approach, conceptual roadway plans, conceptual bridge plans, and maintenance of traffic narrative/plans.
- b. Identify materials, designs, and construction methods that would minimize maintenance costs in the future to the SCDOT or benefit the Project.
- c. Clearly indicate innovation and additional quality items which are a commitment for the project and will be implemented by the Team.
- d. Describe the team's commitment through design and construction to minimizing impacts to wetlands. Quantify the proposed impacts by acre. As shown in the FONSI, 3.032 acres of permanent wetland fill impacts are anticipated for the preferred alternative. During proposal evaluation, SCDOT may assign Innovation and Added Value points for permanent wetland fill impacts that the team commits to avoid/reduce below 3.032 acres.

In the Technical Proposal Appendices, Proposers shall provide the following items.

3. Provide Conceptual Roadway Plans (20 points). The intent of conceptual roadway plans is for the proposer to clearly demonstrate their understanding of requirements of the RFP and the Team's approach to meet those requirements. The quality of the plans will be reviewed and scored for design content and compliance with RFP requirements, including ATC's, if any, rather than plan development/preparation conformance. The following shall be provided.

- a. Typical sections for all roadways, which shall include:
 - Design Speed
 - Functional Classification
 - Lane configuration and widths

- Shoulder widths
- Cross slopes
- Slopes

b. Plan and profile for the entire project limits.

Plan view shall include:

- Geometric layout with reference data (including superelevation data)
- Construction limits
- Proposed Right of Way
- Clear zone limits
- Any roadside barriers (location and type)
- Any bridge and box culverts
- Significant drainage features

Profile view shall include:

- Grades
- Vertical curvature (length & K value)
- Bridge clearance envelopes

- c. Cross sections only where necessary to indicate a significant difference from the conceptual plans in Attachment C or to reflect clear intent of the design. These should be limited to only those showing a significant change and may be segmented for only the areas where changes occur.
- d. Special emphasis details (where needed to clearly demonstrate understanding and approach)

4. Demonstrate an understanding of Maintenance of Traffic (MOT) for the project by providing the following (10 points).

- a. A MOT Narrative that includes any stage durations. The MOT Narrative can be supplemented by plans or drawings and typical sections (11"x17" sheets or roll plots) as necessary to clearly demonstrate the MOT for the project. MOT plans, drawings, and typical sections, if used, may be produced in color or black and white. The narrative should describe the team's approach to minimization of traffic shifts, lane closures, and construction stages.
- b. Discuss the Team's plan to accommodate marine vessel traffic during construction and demolition activities. Describe anticipated disposition of the existing swing-span bridge once traffic has been shifted to the new bridge and during demolition of the existing bridge.
- c. Describe the team's plan for public involvement and notification of traffic impacts including USCG coordination.

5. Provide Conceptual Bridge Plans which shall consist of the following (35 points).

- a. Plan and profile of bridge showing horizontal and vertical clearances and expansion joint locations and types of joint materials.
 - b. Superstructure cross sections and substructure elevations showing pertinent structural elements, dimensions, and types of bearings.
 - c. Construction staging plan for bridge work including dimensions of temporary roadway widths if staging is proposed.
 - d. Bridge construction access plan showing areas used to access the bridge work and showing proposed equipment and material handling locations and staging.
6. Required Forms include.
- a. Stipend Acknowledgement form
 - b. Stipend Agreement
 - c. EEO Certificate
 - d. Non-Collusion Certificate
 - e. Addendum receipt
 - f. Notification receipt of changes to Attachment B
 - g. Updated Organization Chart and Affidavit Statement of Availability of Key Individuals
- Provide the organizational chart from the Proposer's Statement of Qualifications incorporating any approved changes by the SCDOT.
 - The Proposer shall include notarized written statement from the Proposer's Project Manager indicating that the key individuals will be available at the times and durations required in the RFQ and RFP.

The Technical Proposal Narrative and Conceptual Plans submitted as a part of the Technical Proposal will be considered a commitment and shall become part of the contract. Inconsistent and/or non-conforming narrative or Conceptual Plans do not relieve the Proposer of meeting the requirements set forth in the Final RFP at no additional costs to SCDOT.

4.2 Cost Proposal

The Cost Proposal shall be clearly marked as "Confidential Proprietary Information" by the Proposer and shall include the completed Cost Proposal Bid Form provided at the end of this document. The Cost Proposal Bid Form shall be sealed in a separate envelope and delivered as part of the Cost Proposal per the Milestone Schedule.

4.3 Proposal Submittal

Proposals must be submitted separately in two parts, a Technical Proposal and a Cost Proposal. Proposers are required to upload the Technical Proposal, signed forms, and appendices, online through ProjectWise in PDF format. Only one completed submittal per team will be accepted and shall be uploaded by either the lead contracting entity or lead design firm. Please be advised of the time required to set up new account. All

requests for new accounts must be received 72 hours prior to the Proposal deadline indicated in the Milestone Schedule. More information is available at http://www.scdot.org/doing/constructionletting_projectwise.aspx.

Proposers are to physically deliver and submit three printed and bound hard copies of the Technical Proposal, signed forms, and appendices. Proposers are to physically deliver one sealed, printed copy of the Cost Proposal. Please deliver to:

Ms. Carmen Wright
Office of Project Delivery
South Carolina Department of Transportation
955 Park Street, Room 101
Columbia, South Carolina 29202-0191

Proposers are responsible for affecting delivery by the date in the Milestone Schedule. Late submissions will be rejected without opening. SCDOT accepts no responsibility for misdirected or lost Proposals.

4.4 Confidentiality of Proposals

Proposer shall specifically mark as “CONFIDENTIAL” any elements of their submission that they consider to contain confidential or proprietary information, and the release of which would constitute an unreasonable invasion of privacy. All markings must be conspicuous; use color, bold, underlining, or some other method in order to conspicuously distinguish the mark from the other text. Do not mark the entire Proposal as confidential or proprietary. **In the Technical Proposal appendix, Proposer shall include a list of page numbers that contain confidential and/or proprietary information. Failure to include this list in the Technical Proposal appendix waives the confidentiality protection and subjects the information to disclosure in accordance with the law.** In determining whether to release documents, the SCDOT will rely on the Proposer’s marking of each page or portions of pages of documents, as required by these instructions, as being either “Confidential” or “Trade Secret”. Proposer shall be prepared upon request to provide justification of why such materials shall not be disclosed under the South Carolina Freedom of Information Act, Section 30-4-10, et seq., South Carolina Code of Laws (1976) as amended. Proposals will be kept confidential and will not be disclosed, except as may be required by law.

4.5 Non-collusion and Equal Employment Opportunity Certification

Proposers shall certify that they have not participated in any collusion or otherwise taken any action in restraint of free competitive bidding in connection with the submission of this Proposal on this Project. A Proposal submitted without the non-collusion certification may be deemed non-responsive. The non-collusion certification form provided as part of this document shall be submitted as part of the Technical Proposal and will not count against the specified page limit. Each joint venture team member shall submit a separate non-collusion certification.

Proposers shall complete the Equal Employment Opportunity (EEO) Performance Certification form provided as part of this document. A Proposal submitted without the EEO certification may be deemed non-responsive. The EEO certification form shall be submitted as part of the Technical Proposal and will not count against the specified page limit. Each joint venture team member shall submit a separate EEO certification.

5. EVALUATION OF PROPOSALS

5.1 Evaluation Committee

An Evaluation Committee (“Committee”) will be appointed by SCDOT to review the Proposals. The committee members will be comprised of SCDOT employees. In addition, SCDOT will assemble a group of resource members having expertise in the various disciplines required by the Project including FHWA.

5.2 Proposal Review

The Committee will review the Proposals and determine whether each Proposal is responsive based on the Proposal Development criteria in Section 4. Responsive Proposals will be accepted by the Committee for advancement to the Bid Opening. Proposers that submit a non-responsive Proposal will be sent a letter with a detailed explanation as to the reasons for determining non-responsiveness. Any nonresponsive unopened Cost Proposal(s) will be retained by SCDOT until either contract execution or RFP cancelation and then returned to the non-responsive Proposer(s). All original copies of the non-responsive Technical Proposal(s) will be retained by SCDOT. Reasons for determining a Proposal to be non-responsive may result from, but are not limited to, the following: failure to provide all information requested in the Proposal, failure to conform to the material requirements of the RFP, conflict of interests, conditional Proposals, failure to provide complete and honest information, failure to complete the Cost Proposal Bid Form correctly, or failure to submit the EEO certification. Proposals which impose conditions that modify material requirements of the RFP may be rejected as non-responsive. Proposers will not be given an opportunity to correct any material nonconformity. Any deficiency resulting from a minor informality may be clarified or waived at the sole discretion of the SCDOT.

5.3 Technical Evaluation

All Technical Proposals will be evaluated for technical merit and scored on a scale of 0 to 105.0 points prior to opening the Cost Proposals. Scores for the Conceptual Plans will be adjusted based on quality and conformance to the requirements of the RFP with a maximum score of 65.0. A Project Approach and Delivery that meets SCDOT expectations for quality will be scored at 35.0 points. An additional 5.0 points is available for added value and innovation as described in the Innovation and Added Value section. A Proposer will be deemed non-responsive if the evaluation of their Technical Proposal results in a score less than 95.0. The following criteria will be used in determining the Technical Score.

Project Delivery and Approach	35.0 points
Conceptual Roadway Plans	20.0 points
Understanding of MOT	10.0 points
Conceptual Bridge Plans	35.0 points
Innovation & Added Value	5.0 points
Required Forms	<u>Pass/Fail</u>
Total Available	105.0 points

Each member of the Committee will examine each Proposal in detail to measure its contents against the evaluation factors and assign a score to each factor. The Committee will then meet and formulate its collective conclusions. The Committee must discuss significant variations in evaluator’s scores or assessments of technical merit and resolve discrepancies or fully explain them. The Committee will assign the final score for each Technical Proposal by consensus.

5.4 Presentations

Proposers who have submitted responsive Technical Proposals will generally be invited by the Committee to make a presentation. The presentation, if required, will allow the Proposers an opportunity to further explain any aspect of their Technical Proposals, but will not be an opportunity to modify the contents of the proposal. The Committee may address questions to the Proposer after the presentation.

It is anticipated that presentations will be required during selection for this project. Presentations will not be scored independently but information provided during the presentation may be used in the technical evaluation.

5.5 Clarifications

SCDOT, at its sole discretion, shall have the right to seek clarifications from any Proposer to fully understand information contained in their responses to the RFP. Clarifications mean a written or oral exchange of information which takes place after the receipt of Proposals when award without discussions is contemplated. The purpose of clarifications is to address minor or clerical revisions in a Proposal.

5.6 Opening of Cost Proposals/Bid Opening Meeting

All Technical Proposals will be evaluated for responsiveness based on those items requested in this RFP. Those Technical Proposals deemed non-responsive will be handled according to Section 5. As detailed above, those Technical Proposals deemed responsive [Proposals with a technical score of 95.0 or higher] will advance to the Bid Opening.

The Technical Score will be provided confidentially in a sealed envelope to each Proposer at the Opening of Cost Proposals/Bid Opening meeting as shown on the Milestones Schedule in Section 8 of this RFP. After distribution of the Technical

Scores, the Cost Proposals of Proposers with responsive Technical Proposals will be opened.

The Total Bid amount shown on the Cost Proposal Bid Form and the Technical Score for each respective Proposer will be entered into a spreadsheet and analyzed. The Total Bid will be evaluated in accordance with FHWA's Guidelines on Preparing Engineer's Estimates, Bid Reviews, and Evaluation. Each Total Bid will be compared against the confidential SCDOT Engineer's Estimate.

If upon analysis, one or more of the Total Bids is within an acceptable range of the Engineer's Estimate and there are no apparent concerns with the Proposals, all Total Bids (including the A and B portions if applicable) and Technical Scores for each Proposer will be read aloud.

If upon analysis, all of the Total Bids exceed an acceptable range of the Engineer's Estimate or there are concerns with the Proposals, the Total Bids and Technical scores may not be read aloud and the meeting will adjourn. SCDOT personnel may then assess if either award outside the prescribed range is justified or if the SCDOT will hold discussions in accordance with Section 5.8.

SCDOT intends to award the contract to the Proposer with the lowest Total Adjusted Bid. However, the RFP may be cancelled after opening, but prior to the issuance of an award, when such action is determined in writing to clearly be in the best interest of the State. If the RFP is cancelled, Cost Proposals may be returned to the Proposers and a new solicitation may be conducted for the Project.

5.7 Discussions

If necessary, after the Bid Opening Meeting, SCDOT may hold confidential discussions with each responsive Proposer relating to aspects of their respective Proposal. The discussion process is intended to assure that Proposers fully understand the requirements of the RFP and that the evaluation team fully understands each qualified Proposer's Technical Proposal and the Proposer's ability to perform as needed. Discussions involve only a limited exchange of information. Discussions are not negotiations. If SCDOT determines that discussions are necessary, SCDOT will forward a written invitation to the responsive Proposers.

SCDOT reserves the right to hold multiple discussions at any length of time with all of Proposers. All discussions shall be controlled by the SCDOT POC. Proposers shall not communicate with any other SCDOT employees regarding these discussions except at the appropriate discussion meetings.

At the conclusion of discussions, SCDOT may either 1.) proceed with award of the contract to the selected Proposer based on the lowest Total Adjusted Bid at the Bid Opening Meeting; 2.) issue a Request for Best and Final Offers; or 3.) cancel the procurement.

5.8 Best and Final Offer

At the conclusion of discussions, if SCDOT determines that Proposal revisions are warranted, SCDOT may issue a Request for Best and Final Offer (BAFO). If necessary, SCDOT may also revise the RFP to provide clarifications related to the Request for BAFO. The Request for BAFO will include instructions for preparing and submitting the BAFO and will include a new Milestone Schedule. If only Cost Proposal revisions are warranted, Proposers will revise and resubmit, and SCDOT will hold a second Bid Opening Meeting. If Technical Proposal revisions are warranted, Proposers will revise and resubmit, and the procurement process will return to Section 5.

Only one Request for BAFO can be issued for this RFP. If upon analysis of the BAFO's, all of the bids exceed an acceptable range of the Engineer's Estimate, SCDOT will adjourn the BAFO Bid Opening Meeting. SCDOT personnel may then assess if either award outside the prescribed range is justified or if the RFP will be cancelled.

The discussion and BAFO process do not alter or amend the RFP requirement that Proposers agree to hold their Proposal offers available for acceptance a minimum of 90 calendar days after the Bid Opening Meeting.

5.9 Total Adjusted Bid Determination

Award of the Contract, if made, will be made to the responsible and qualified Proposer who submits the lowest Total Adjusted Bid. To determine the Total Adjusted Bid, the sum of each Proposer's Total Cost to Complete will be divided by their Technical Score. In the event that two or more Proposers are determined to have the same lowest Total Adjusted Bid, the award, if made, will be made to the Proposer with the highest Technical Score. The following formula will be used to evaluate the values given on the Cost Proposal Bid Form:

Total Adjusted Bid = (A/Technical Score):

A Total Cost to Complete all work to be performed under the contract

Technical Score is assigned a value from 0 to 105.0 based on the Proposal's technical merit; expressed as a decimal – i.e., a technical score of 98.2 would be expressed as 0.982

Example for Determining Total Adjusted Bid

Proposal	Total Cost to Complete (A)	Technical Score	Total Adjusted Bid
A	\$30,000,000	0.95	\$31,578,947.37
B	\$35,000,000	0.90	N/A
C	\$38,000,000	1.00	\$38,000,000.00
D	\$31,000,000	1.05	\$29,523,809.52

Note: In this example, Proposal B was determined to be non-responsive and Proposal D was determined to be the lowest Total Adjusted Bid.

5.10 Protest

5.10.1 Grounds for Protest

Protest of Contents of Solicitation (Invitation For Bids or RFPs or other solicitation documents, whichever is applicable, or any amendment to it, if the amendment is at issue): Any Proposer who is aggrieved in connection with a solicitation document shall file a written protest to SCDOT's Chief Procurement Officer (CPO), PO Box 191, Columbia, SC 29202, within five business days of the date of posting of the solicitation, RFQ, RFP, or other solicitation document or any addendums to it on the SCDOT design-build website.

Protest of Short-listing: Any Protestant who is aggrieved in connection with the selection of short-listed Proposers shall file a written protest with the CPO within five business days of the date the short-list is posted on SCDOT design-build website. Any matter that could have been raised pursuant to the Protest of Contents of Solicitation, section above, may not be raised as a protest of the selection of the short-list. The number of Proposers short-listed is not grounds for a protest.

Protest of Award: Any Protestant who is aggrieved in connection with the award of the contract shall file a written protest with the CPO within five business days of the date the Request to Award memorandum is posted on SCDOT design-build website. Any matter that could have been raised pursuant to the protest of contents of solicitation or short-listing, section above, may not be raised as a protest of award.

Exclusive remedy: The rights and remedies granted in this section to Proposers, either actual or prospective, are to the exclusion of all other rights and remedies of Proposers against the SCDOT.

Failure to file a timely protest: If protestant fails to request a protest within the five business days, the short-list and award shall be final.

5.10.2 SCDOT Procedures for Protest

Protest: A protest must be in writing, filed with the CPO, and set forth the grounds of the protest and the relief requested with enough specificity to give notice of the issues to be decided. The protest must be received by the CPO within the time provided.

Burden of Proof: The protestant challenging SCDOT's action bears the burden of proving the decision is arbitrary.

Duty and Authority to Attempt to Settle Protests: Before commencement of an administrative review, the CPO, or a designee of the CPO, may attempt to settle by mutual agreement a protest of an aggrieved Protestant, actual or prospective, concerning the solicitation, short-listing, or award of the contract. Any settlement reached by mutual agreement shall be approved by the CPO.

Administrative Review and Decision: If, after reasonable attempt, a protest cannot be settled by mutual agreement, the CPO, or a designee, shall promptly conduct an administrative review. The CPO shall commence the administrative review no later than five business days after a reasonable settlement attempt and shall issue a decision in writing within five business days of completion of the review. The decision must state the reasons for the action taken. The decision shall include findings of fact and conclusions of law, separately stated. A copy of the decision along with a statement of appeal rights set forth below must be mailed or otherwise furnished immediately to the protestant.

Finality of Decision and Appeal: The SCDOT's decision pursuant to the above paragraph is final and conclusive. A person adversely affected by the final decision can appeal to circuit court and hereby waives a trial by jury regarding any protest arising out of this procurement and any such trial will be a non-jury trial before the South Carolina Circuit Court in Richland County.

Stay of Award: The contract award is stayed until issuance of a final decision by the SCDOT. Once a final decision is issued, the filing of a petition to appeal that decision does not itself stay enforcement of SCDOT's decision to award the contract. SCDOT may grant or the reviewing court may order, a stay upon appropriate terms.

All Freedom of Information (FOIA) requests will be sent to the FOIA Officer in the SCDOT Office of Chief Counsel.

6. SELECTION OF CONTRACTOR

The Chairman of the Committee will present a report regarding the review of the Proposals along with the Bid Opening results to SCDOT Director of Construction's Office and recommend selection of the Proposer with the lowest Total Adjusted Bid. The Director of Construction's Office will prepare a Secretary of Transportation Record of Approval Form requesting authorization to award and execute a contract. Upon approval by the SCDOT Secretary of Transportation, SCDOT will offer a contract to the selected Proposer. However, if the parties are unable to execute a contract, SCDOT may offer a contract to the Proposer with the next lowest Total Adjusted Bid.

The Design-Build Agreement will be executed for the Total Cost to Complete as shown in the Cost Proposal Bid Form.

7. GENERAL INFORMATION

SCDOT reserves the right to terminate the evaluation of one or more of the Proposals if it is determined to be in the best interest of the state to do so.

SCDOT reserves the right, at its sole discretion, to either cancel this solicitation or to re-advertise in another public solicitation when it is in the best interest of the state to do so.

SCDOT reserves the right to reject any and all Proposals, or parts thereof, and/or to discontinue contract execution with any party at any time prior to final contract execution.

SCDOT assumes no liability and will not reimburse costs incurred by firms, whether selected or not, in developing Proposals or in contract execution.

SCDOT reserves the right to request or obtain additional information about any and all Proposals. SCDOT may also issue addendums to the RFP, which will be posted on the website and emailed to all Proposers' Points of Contact.

SCDOT reserves the right to revise or amend the RFP, specifications and/or drawings, including changes to the date the Proposal is due. Such changes, if any, will be announced by an addendum(s) to this RFP. All information relating to this RFP, including pertinent changes/addendums and other applicable information will be posted on SCDOT's Design-Build website http://www.scdot.org/doing/constructionletting_designbuild.aspx. If changes are made to the RFP within 10 days of the due date, Milestones may be adjusted accordingly. Proposers are strongly cautioned to check this site frequently to ensure they have the latest information.

Receipt of an addendum by the Proposer must be acknowledged in the space provided on the Addendum Notice to Proposer Transmittal Form posted on the SCDOT Design-Build website for this Project. Proposers shall submit the signed Notice with its Technical Proposal response to this RFP. Failure to acknowledge an addendum may result in rejection of the Proposal. Explanations or instructions given in a form other than an addendum or ATC response letter shall not be binding.

After award, if an unsuccessful Proposer would like to schedule a debriefing, Proposer shall submit a request within three business days from the date the award notification is posted on the SCDOT Design-Build website for this Project. Only written requests (emails are acceptable) for a debriefing will be scheduled. Failure to request a debriefing within the three business day period waives the opportunity for a debriefing.

Proposer shall be held responsible for the validity of all information supplied in its Proposal, including that provided by potential subcontractors. Should subsequent investigation disclose that the facts and conditions were not as stated, the Proposal may be rejected or contract terminated for default if after award, in addition to any other remedy available under the contract or by law.

Proposer, by submitting a Proposal, represents that it has read and understands the RFP, its exhibits, attachments and addendums, and that its Proposal is made in compliance with the criteria of the RFP. Proposers are expected to examine the RFP, its exhibits, attachments and addendums thoroughly and should request an explanation of any ambiguities, discrepancies, errors, omissions, or conflicting statements therein. Failure to do so will be at the Proposer's risk. Proposer assumes responsibility for any patent ambiguity in the RFP, its exhibits, attachments and addendums that Proposer does not bring to SCDOT's attention.

No Proposal guaranty in the form of a Bid Bond is required for this procurement.

Proposal Acceptance Period - By submitting a Proposal, Proposer agrees to hold the Proposal offer available for acceptance a minimum of 90 calendar days after the Bid Opening date.

A business day is hereby defined as a day in which SCDOT Headquarters is open for business.

8. MILESTONE SCHEDULE

Milestone Schedule	Date/Time
Provide RFP for Industry Review to Short-list Proposers	Thursday, March 23, 2017
Deadline for Proposers to submit Comments/Questions on the RFP for Industry Review	Thursday, April 6, 2017 by 12:00pm EST
Open-Forum Meeting with Proposers for RFP for Industry Review Clarifications/Comments	Thursday, April 20, 2017 at 10:00am EST
Issue Final RFP	Thursday, April 27, 2017
Submittal of Preliminary ATC Package and Confidential Questions	Thursday, May 4, 2017 by 12:00pm EST
Confidential Preliminary ATC and Confidential Questions One-on-One Meetings with Proposers	Thursday, May 18, 2017
Submittal of Non-Confidential Questions	Tuesday, May 23, 2017 by 12:00pm EST
SCDOT Responds to Preliminary ATCs	Tuesday, May 23, 2017
Submittal of Formal ATCs for Initial Review and Submittal of Confidential Questions	Friday, June 2, 2017 by 12:00pm EST
SCDOT Responds to Formal ATCs with final determination, asks questions/requests information, or provides conditional responses	Wednesday, June 14, 2017
Submittal of Non-Confidential Questions	Wednesday, June 14, 2017 by 12:00pm EST
Confidential Formal ATC One-on-One Meetings	Thursday, June 15, 2017
Resubmittal of Formal ATCs in its final form (no revisions allowed after this submittal, unless requested by SCDOT)	Thursday, June 22, 2017 by 12:00pm EST
SCDOT's Final Determination for Formal ATCs	Thursday, June 29, 2017
Submittal of Non-Confidential Questions	Thursday, July 6, 2017 by 12:00pm EST
Submittal of Technical Proposals	Thursday, July 27, 2017 by 8:30am EST
Submittal of Cost Proposals	Thursday, August-8 10, 2017 by 12:00pm EST
Technical Proposal Presentations	Week of August 14, 2017
Bid Opening (with team representatives present)	Thursday, August 24, 2017 at 10:00am EST

9. COST PROPOSAL BID FORM

**US 21 over Harbor River Bridge Replacement
Beaufort County**

CONTRACTOR: _____

ADDRESS: _____

Provide full Project scope as described in Attachment A.

TOTAL COST TO COMPLETE (A) = _____

No conditional Bids will be accepted. SCDOT reserves the right to delete any or all conditions placed on the Total Cost to Complete, and/or reserves the right to reject any Bid that is conditional or contains additions not called for in the plans and specifications.

Signature

Date

Printed Name

10. NON-COLLUSION CERTIFICATION

NON-COLLUSION CERTIFICATION

Project ID: P026862

IN ACCORDANCE WITH THE PROVISIONS OF S.C. CODE ANN. §§ 39-3-10 ET.SEQ., 39-5-10 ET. SEQ., 15 U.S.C. §45; 23 C.F.R. §635.112(F); AND 28 U.S.C. §1746, I HEREBY ACKNOWLEDGE THAT I AM AN OFFICER OF THE PROPOSER FIRM AND, UNDER PENALTY OF PERJURY UNDER THE LAWS OF THE UNITED STATES AND SOUTH CAROLINA, DECLARE, BY MY CERTIFICATION BELOW, THAT THE FOLLOWING IS TRUE AND CORRECT, AND FURTHER, THAT THIS FIRM, ASSOCIATION OR CORPORATION HAS NOT, EITHER DIRECTLY OR INDIRECTLY, ENTERED INTO ANY AGREEMENT, PARTICIPATED IN ANY COLLUSION, OR OTHERWISE TAKEN ANY ACTION IN RESTRAINT OF FREE COMPETITIVE BIDDING IN CONNECTION WITH THE SUBMISSION OF A BID PROPOSAL ON THE ABOVE REFERENCED PROJECT.

BY CHECKING THIS BOX , I CERTIFY THAT I HAVE READ, UNDERSTAND, ACCEPT, AND ACKNOWLEDGE ALL OF THE ABOVE STATEMENTS.

Executed on _____
(Date)

Signed: _____
(Officer/Proposer)

(Title)

(Address)

11. EQUAL EMPLOYMENT OPPORTUNITY CERTIFICATION

(COMPLETE THIS SECTION FOR FEDERAL PROJECTS ONLY) EQUAL EMPLOYMENT OPPORTUNITY PERFORMANCE

Select the Certification that applies to the PROPOSER:

Certification (1) or Certification (2)

Select the appropriate responses in the applicable Certification:

Certification (1): Pursuant to 41 C.F.R. §60-1.7(b)(1), Previous Equal Employment Opportunity Performance Certification, as the Prospective Prime Contractor, I HEREBY CERTIFY THAT I:

(a) **(HAVE / HAVE NOT)** developed and filed an Affirmative Action Program pursuant to 41C.F.R. §60-2 and/or 60-4;

(b) **(HAVE / HAVE NOT)** participated in a previous contract or subcontract subject to the equal opportunity clause;

(c) **(HAVE / HAVE NOT)** filed with the Joint Reporting Committee, the Director of Office of Federal Contract Compliance, or the Equal Employment Opportunity Commission, all reports due under the applicable filing requirements,

OR

Certification (2): I, HEREBY CERTIFY that as the Prospective Prime Contractor submitting this Proposal, **(CLAIM / DO NOT CLAIM)** exemption from the submission of the Standard Form 100 (EEO-1) due to the fact that it employs a total of less than fifty (50) employees under C.F.R. §60-1.7, or qualifies for an exempted status under 41 C.F.R. §60-1.5.

I FURTHER CERTIFY that the above Certification will be made part of any Subcontract Agreement involved with this project.

Executed on _____, 20 ____ .

Signed: _____
(Officer/PROPOSER)

Title: _____

Company: _____

Address: _____

Note: The above certification is required by the Equal Employment Opportunity Regulations of the Secretary of Labor (41 CFR 60-1.7(b)(1)), and must be submitted by PROPOSERS only in connection with contracts which are subject to the equal opportunity clause. Contracts that are exempt from the equal opportunity clause are set forth in 41 CFR 60-1.5. (Generally, only contracts of \$10,000 or under are exempt.)

Currently, Standard Form 100 (EEO-1) is the only report required by Executive Orders or their implementing regulations.

Proposers, Primary Members, or proposed Contractors and Consultants who have participated in a previous contract subject to the Executive Orders and have not filed the required reports shall note that 41 CFR 60-1.7(b)(1) prevents the award of contracts and subcontracts unless such contractor submits a report covering the delinquent period or such other period specified by the Federal Highway Administration or by the Director, Office of Federal Contract Compliance, U.S. Department of Labor.

12. STIPEND ACKNOWLEDGEMENT FORM

Stipend Acknowledgement Form

**US 21 over Harbor River Bridge Replacement
Beaufort County**

Proposer: _____

ADDRESS: _____

The undersigned Proposer, hereby:

Waives the stipend for this Project.

Accepts the stipend for this Project.

By accepting the stipend for this Project, Proposer agrees:

- 1) to execute and include the Stipend Agreement in Article XIII of the RFP with their RFP response;
- 2) SCDOT will pay the stipend to each eligible unsuccessful Proposer, who has signed a Stipend Agreement, within ninety (90) days after execution of the contract or the decision not to award a contract;
- 3) to transfer all rights to its Work Product used to develop the Proposal as of the date of this acknowledgement. "Work Product" means all submittals, including ATCs, ideas, innovations, solutions, methods, processes, design concepts, materials, electronic files, marked up drawings, cross sections, quantity lists and intellectual property, made by Proposer during the RFP process, including the Proposal, exchange of information during the pre-Proposal and post-Proposal period.

Date

Proposer

Print Name

13. STIPEND AGREEMENT

STIPEND AGREEMENT Project ID: P026862 US 21 over Harbor River Bridge Replacement Beaufort County

THIS STIPEND AGREEMENT (the “Agreement”) is made and entered into as of the ___ day of _____, 20_, by and between the SOUTH CAROLINA DEPARTMENT OF TRANSPORTATION (hereinafter “SCDOT”), and _____ (“Proposer”), with reference to the following facts:

SCDOT issued a Request for Proposal (“RFP”) for design and construction of the above-referenced Design-Build Project (“Project”), pursuant to procurement authority granted in Section 57-5-1625 of the S.C. Code of Laws, 1976, as amended. The RFP provided for payment of stipends as provided herein.

NOW, THEREFORE, Proposer hereby agrees as follows:

1. Work Product.

1.1 Proposer shall prepare and submit a responsible and responsive technical and cost Proposal that conforms in all material respects to the requirements and provisions of the RFP, as determined by SCDOT, and are timely received by SCDOT in accordance with the RFP Milestone Schedule.

1.2 By signing this Stipend Agreement, Proposer agrees to transfer ownership to SCDOT of the electronic copy and hard copy of all Work Product used to develop the Proposal. The Work Product (as defined below) shall become the property of SCDOT without restriction or limitation on its use, without further compensation or consideration, and can be used in connection with this Project or any future projects by SCDOT. Neither Proposer nor any of its team members shall copyright any of the material developed under this Agreement.

1.3 The term “Work Product” shall mean all material, electronic files, marked up drawings, cross sections, quantity lists, submittals, alternative technical concepts (ATC), ideas, innovations, solutions, methods, processes, design concepts, and intellectual property, made by or produced for Proposer in the development and submission of the technical and price Proposals, including exchanges of information during the pre-Proposal and post-Proposal period.

2. Compensation and Payment.

2.1 A stipend to Proposer for the Work Product described herein shall be \$100,000 and is payable on condition that Proposer (1) submitted a responsible and responsive technical and cost Proposal to the RFP which is not selected for award of this Project, or (2) was awarded the Contract but the Contract was terminated by SCDOT at SCDOT’s convenience after the Submittal of Proposal Date (See Final RFP Milestone schedule) but prior to the Notice to Proceed #1. Responsibility and responsiveness of the Proposal will be determined by SCDOT as a condition of payment.

2.2 SCDOT will pay the stipend to Proposer under the following conditions:

(a) Within ninety (90) days after execution of the contract or the decision not to award a contract, SCDOT will pay the stipend to the unsuccessful Proposer meeting the criteria of Section 2.1, provided that the Proposer submitted a signed a Stipend Agreement with its response to the RFP.

(b) If the procurement is suspended or cancelled prior to the Proposal Due Date (see FINAL RFP Milestone schedule), no stipend will be paid to Proposer.

(c) After the submittal of Proposals, but prior to award, if the procurement is cancelled, all Proposers that provide a responsive technical and cost Proposal to the final RFP and submitted a signed Stipend Agreement with their RFP shall receive the stipend

(d) In the event of a Best and Final Offer, only one stipend will be paid.

(e) No stipends will be paid for submitting RFQ responses.

2.3 Acceptance by the Proposer of payment of the stipend amount from SCDOT shall constitute a waiver by Proposer of any and all right, equitable or otherwise, to bring any claim in connection with this procurement, procurement process, award of the Contract, or cancellation of this procurement.

2.4 The Proposer awarded the contract shall be not eligible to receive a stipend.

2.5 If Proposer elects to waive payment of the stipend, SCDOT will not use the ideas or information contained in that Proposer’s Proposal for this Project. However, the Proposer’s Proposal will be subject to the South Carolina Freedom of Information Act.

3. Indemnities.

3.1 Subject to the limitations contained in Section 3.2, Proposer shall indemnify, protect and hold harmless SCDOT and its directors, officers, employees and contractors from, and Proposer shall defend at its own expense, all claims, costs, expenses, liabilities, demands, or suits at law or equity arising in whole or in part from the negligence or willful misconduct of Proposer or any of its agents, officers, employees, representatives or subcontractors or breach of any of Proposer’s obligations under this Agreement.

3.2 This indemnity shall not apply with respect to any claims, demands or suits arising from use of the Work Product by SCDOT.

4. Compliance With Laws.

4.1 Proposer shall comply with all federal, state, and local laws, ordinances, rules, and regulations applicable to the work performed or paid for under this Agreement and covenants and agrees that it and its employees shall be bound by the standards of conduct provided in applicable laws, ordinances, rules, and regulations as they relate to work performed under this Agreement. Proposer agrees to incorporate the provisions of this paragraph in any subcontract into which it might enter with reference to the work performed pursuant to this Agreement.

4.2 The Proposer agrees (a) not to discriminate in any manner against an employee or applicant for employment because of race, color, religion, creed, age, sex, marital status, national origin, ancestry or disability of a qualified individual with a disability; (b) to include a provision similar to that contained in subsection (a) in any subcontract; and (c) to post and to cause subcontractors to post in conspicuous places available to employees and applicants for employment, notices setting forth the substance of this clause.

5. Assignment.

Proposer shall not assign this Agreement without SCDOT’s prior written consent. Any assignment of this Agreement without such consent shall be null and void.

6. Miscellaneous.

6.1 Proposer and SCDOT agree that Proposer, its team members, and their respective employees are not agents of SCDOT as a result of this Agreement.

6.2 This Agreement, together with the RFP, as amended from time to time, the provisions of which are incorporated herein by reference, embodies the entire agreement of the parties. There are no promises, terms, conditions, or obligations other than those contained herein or in the RFP, and this Agreement shall supersede all previous communications, representation, or agreements, either verbal or written, between the parties hereto.

6.3 It is understood and agreed by the parties hereto that if any part, term, or provision of this Agreement is by the courts held to be illegal or in conflict with any law of the State of South Carolina, the validity of the remaining portions or provisions shall not be affected, and the rights and obligations of the parties shall be construed and enforced as if the Agreement did not contain the particular part, term, or provisions to be invalid.

6.4 This Agreement shall be governed by and construed in accordance with the laws of the State of South Carolina.

IN WITNESS WHEREOF, the parties have executed this Agreement as of the date first written above.

SOUTH CAROLINA DEPARTMENT
OF TRANSPORTATION

Witness:

By: _____
Chris J. Gaskins, P.E.
Design-Build Engineer

Recommended:

Proposer

W. Tyke Redfearn, P.E.
Design-Build Program Manager

Name of Proposer

Witness:

By: _____

Its: _____

AGREEMENT

**AGREEMENT
FOR THE DESIGN & CONSTRUCTION
of**

US 21 over Harbor River Bridge Replacement

Beaufort County, South Carolina

A DESIGN-BUILD PROJECT

**BETWEEN
SOUTH CAROLINA DEPARTMENT OF TRANSPORTATION
AND**

_____ day of _____, 2017

Project ID P026862

Table of Contents

I.	CONTRACT DOCUMENTS	6
II.	PROJECT SCOPE	6
	A. SCOPE OF WORK	6
	B. DESIGN AND CONSTRUCTION RESPONSIBILITIES	6
	C. DESIGN CRITERIA	7
	D. DESIGN REVIEW	8
	E. MAINTENANCE OF TRAFFIC	9
	F. OWNERSHIP OF DOCUMENTS	9
	G. CONSTRUCTION CRITERIA	10
	H. PROJECT MANAGEMENT	10
	I. CONTROL OF THE WORK	11
	J. CONTRACT DELIVERABLES	11
III.	CONTRACT PRICE/CONTRACT PAYMENTS	13
	A. CONTRACT PRICE	13
	B. CONTRACT PRICE ADJUSTMENTS	13
	C. CONTRACT PAYMENTS	15
	D. RETAINAGE	17
IV.	CONTRACT TIME	17
	A. PROJECT SCHEDULE	17
	B. CONTRACT TIME ADJUSTMENTS	20
	C. OWNER'S RIGHT TO STOP WORK	20
	D. LIQUIDATED DAMAGES	21
V.	QUALITY ASSURANCE PROGRAM	21
	A. CONTRACTOR'S RESPONSIBILITIES	21
	B. SCDOT RESPONSIBILITIES	23
	C. CONTRACTOR'S OBLIGATION	23
VI.	INSURANCE AND BONDING	24
	A. INSURANCE	24
	B. BONDING	27
VII.	UTILITIES AND RAILROAD COORDINATION	28
VIII.	RIGHT OF WAY ACQUISITION	31
	A. RIGHT OF WAY SERVICES	31
	B. ACQUISITION OF RIGHT-OF-WAY	34
IX.	PERMITS	35
X.	ENVIRONMENTAL COMPLIANCE	36
	A. COMPLIANCE WITH ENVIRONMENTAL COMMITMENTS	36
	B. PRECONSTRUCTION / PARTNERING CONFERENCE(S)	37
	C. PROTECTION OF ARCHEOLOGICAL AND PALEONTOLOGICAL REMAINS AND MATERIALS	37
	D. COMMUNITY AND PUBLIC RELATIONS PLAN	37
XI.	HAZARDOUS MATERIALS	38
XII.	DEMOLITION, REMOVAL & DISPOSAL OF STRUCTURES	40

US 21 over Harbor River Bridge Replacement
Beaufort County

XIII. DIFFERING SITE CONDITIONS	40
XIV. FORCE MAJEURE.....	40
XV. WARRANTY	41
XVI. INDEMNITY	42
XVII. TERMINATION AND CANCELLATION	42
A. TERMINATION FOR DEFAULT	42
B. TERMINATION FOR CONVENIENCE	43
XXVIII. DISADVANTAGED BUSINESS ENTERPRISES	44
XIX. ON-THE-JOB TRAINING REQUIREMENTS	44
XX. RECORD RETENTION	44
XXI. AS-BUILTS.....	44
XXII. ESCROW PROPOSAL DOCUMENTS	46
XXIII. DISPUTE RESOLUTION	46
XXIV. SCDOT’S AGENT.....	46
XXV. ASSIGNABILITY	46
XXVI. GENERAL PROVISIONS	47
CERTIFICATION OF CONTRACTOR.....	49
CERTIFICATION OF DEPARTMENT	50
DRUG-FREE WORKPLACE CERTIFICATION	51

LIST OF EXHIBITS

1. Cost Proposal Bid Form
2. Schedule of Values
3. Scope of Work
4. Project Design Criteria
 - 4a. Roadway Design Criteria
 - 4b. Structures Design Criteria
 - 4c. Pavement Design Criteria
 - 4d. Traffic Design Criteria
 - Part 1 – Signing and Pavement Marking
 - Part 2 – Work Zone Traffic Control
 - Part 3 – Traffic Signals
 - Part 4 – Intelligent Transportation System
 - 4e. Hydraulic Design Criteria
 - 4f. Geotechnical Design Criteria
 - 4g. Environmental Design Criteria
 - 4z. Project Design Deliverables
5. Special Provisions and Contract Requirements

US 21 over Harbor River Bridge Replacement
Beaufort County

WHEREAS, the South Carolina Department of Transportation, as an agency of the State of South Carolina, wishes to improve the safety and operation of the state highway system by constructing a new bridge and ~~replacing~~ removing the existing bridge over the Harbor River along US Route 21 (Sea Island Parkway) in Beaufort County (hereinafter referred to as “the Project”); and

WHEREAS, the South Carolina Department of Transportation, as a servant of the people of the State of South Carolina, wishes to see this strategic project completed; and

WHEREAS, limitations imposed by traditional methods of designing, and constructing highways would mean that the Project could be completed only after an unacceptable delay; and

WHEREAS, the South Carolina Department of Transportation, working with the Federal Highway Administration (FHWA), has devised an innovative plan to allow the commencement and completion of the Project in a timely and cost-effective manner; and

WHEREAS, pursuant to Section 57-5-1625 SC Code of Law, the South Carolina Department of Transportation desires to award a highway construction contract using a Design / Build procedure; and

WHEREAS, after a competitive process, CONTRACTOR has been selected to participate in this venture by designing and building the Project; and

WHEREAS, the South Carolina Department of Transportation wishes to avail itself of and rely on CONTRACTOR’s expertise and proven track record in designing and constructing such projects, on time and within budget; and

WHEREAS, CONTRACTOR wishes to provide that expertise and to participate in this venture for the good of the people of the State of South Carolina;

NOW THEREFORE, this Agreement is executed and made, effective as of the Effective Date as defined herein, between the SOUTH CAROLINA DEPARTMENT OF TRANSPORTATION (“SCDOT”) and _____ (“CONTRACTOR”). In consideration of the covenants hereinafter set forth, the parties hereto mutually agree as follows:

I. CONTRACT DOCUMENTS

The Contract shall be composed of this Agreement and all exhibits, SCDOT's Request for Proposals and all attachments, Request for Qualifications and all attachments, CONTRACTOR's Proposal and all attachments, and CONTRACTOR'S Qualifications and all attachments. In case of conflict, the order of precedence of the Contract documents shall be: (1) this Agreement; (2) Agreement Exhibits; (3) SCDOT Request for Proposals (RFP) document and Attachment B; (4) CONTRACTOR's Proposal and attachments; and (5) SCDOT Request for Qualifications (RFQ) and CONTRACTOR's Statement of Qualifications (SOQ). In the event of a conflict between the Project Criteria and Special Provisions identified in the Agreement Exhibits, the order of precedence shall be (1) the Project Criteria and (2) Special Provisions. Attachment C is the project information package and is provided for information only. SCDOT shall not be liable for the accuracy of the information contained therein.

II. PROJECT SCOPE

A. Scope of Work

CONTRACTOR shall furnish all services, labor, materials, equipment, supplies, tools, transportation, and coordination required to perform all design, preliminary engineering, surveying, geotechnical services, scheduling, permitting, right of way services, procurement, construction, utility coordination, demolition, material disposal and any other services necessary to perform the Project as defined in the Project Scope of Work made a part hereof as **EXHIBIT 3**.

B. Design and Construction Responsibilities

1. CONTRACTOR, consistent with applicable state licensing laws, shall provide, through qualified South Carolina licensed design professionals employed by CONTRACTOR or procured from qualified, independent South Carolina licensed design consultants, the necessary design work, including, but not limited to, surveys, right of way services, roadway design, maintenance of traffic, geotechnical exploration and design, hydraulic analyses, storm water management, erosion control, superstructure design, and foundation and substructure design including seismic analyses for the preparation of the required drawings, specifications and other design submittals to permit CONTRACTOR to complete the work in accordance with the Contract.
2. CONTRACTOR shall provide through itself or subcontractors the necessary supervision, labor, inspection, testing, material, equipment, machinery, temporary utilities and other temporary facilities to permit performance of all demolition, earthwork, drainage, foundation work, maintenance of traffic, roadway work, structural work, excavation, erosion and sediment control work, field layout work, construction management and inspection, utility coordination and relocation, ~~railroad coordination~~, CONTRACTOR quality control, and all other work necessary to complete construction of the Project in accordance with the Contract.

CONTRACTOR shall perform all design and construction activities efficiently and with the requisite expertise, skill and competence to satisfy the requirements of the Contract. CONTRACTOR at all times shall exercise control over the means, methods, sequences and techniques of construction. CONTRACTOR's operations and construction methods shall comply with all applicable federal, state and local regulations with regard to worker safety, protection and health and protection of the environment and applicable permit requirements.

3. CONTRACTOR shall design and construct the project in such a manner that the construction limits are contained within the approved environmental footprint to the extent possible. Where new right of way is required to construct the Project, the CONTRACTOR shall design and construct the Project so as to minimize the additional rights of way needed. The acquisition of rights of way, including both cost and services to acquire, shall be the responsibility of the CONTRACTOR and shall be done in accordance with Article VIII of this Agreement. CONTRACTOR shall furnish the SCDOT a copy of any agreements for the use of additional properties not acquired as right of way that are used in conjunction with the construction of this Project. CONTRACTOR shall abide by the provisions of all applicable environmental permits, any conditions of individual right of way agreements, and all environmental commitments. The CONTRACTOR shall sign the Contractor Certification Form and this agreement will be made part of the contract.
4. It shall be the responsibility of CONTRACTOR to determine and comply with all applicable federal, state, and local laws in connection with the services set forth in this Contract. This obligation shall include, but not be limited to, procurement of all permits and licenses not obtained by SCDOT provided, however, that with respect to any permit or licenses that must be obtained in the name of SCDOT, CONTRACTOR shall perform all functions within its power to obtain the permit, including mitigation, and SCDOT will fully cooperate in this effort and perform any functions that must be performed by SCDOT. CONTRACTOR shall be responsible for payment of all charges, fees, and taxes, and for providing all notices necessary and incident to the performance of the Project as of the Effective Date of this Agreement. The Contract Price shall include fees related to the above obligations and if any fees are waived by the regulatory or governmental entity, then the amount of the fee waived shall be deducted from the Contract Price.

C. Design Criteria

It shall be the responsibility of CONTRACTOR to design all aspects of the Project in accordance with the contract documents. For the Project, CONTRACTOR shall provide a completed set of construction plans signed and sealed by a licensed professional engineer in South Carolina. CONTRACTOR shall be fully responsible for the accuracy of the design and compliance with specifications, standards and Project Criteria.

D. Design Review

1. Prior to the Preconstruction Meeting, CONTRACTOR shall provide a Draft Design Review Submittal Schedule to SCDOT. The Design Review Submittal Schedule shall include a Gantt chart of the submittals and will serve as the basis for reviewing the design and construction plans. The Design Review Submittal Schedule and Gantt chart shall be updated as requested by SCDOT and included with each submittal package. CONTRACTOR, CONTRACTOR'S design consultant, subcontractors, suppliers and SCDOT shall discuss the schedule and procedures for submitting design plans at the Preconstruction Meeting. CONTRACTOR, CONTRACTOR'S design consultant, subcontractors and suppliers shall not submit any design work until the Design Review Submittal Schedule is approved by SCDOT.
2. All submittals and supporting documentation shall be uploaded electronically to ProjectWise and an email shall be sent to SCDOT that verifies the contents of the upload. A complete package shall be limited to one phase (ex. Preliminary/ROW/Final/RFC) of one segment or structure and include all deliverables specified in Exhibit 4. Prior to beginning any construction activities, permanent or temporary, the Traffic Management Plan and Conceptual Work Zone Traffic Control plans for the entire project shall be submitted by the CONTRACTOR and approved by SCDOT. If approved by SCDOT, one Maintenance of Traffic package, including but not limited to, an NPDES permit application and related plans, may be allowed to provide the opportunity to begin construction of non-permanent work items, such as clearing and grubbing, shoulder strengthening, minor demolition not adversely impacting traffic or operations, etc.
3. CONTRACTOR shall provide plans, reports, and documents as defined in Exhibit 4. Prior to commencement of permanent construction activities, SCDOT will have the right, but not the obligation, to review and comment upon all submittals. The review period will begin the first business day after the submittal package is uploaded to ProjectWise. No more than one package shall be submitted within a five business day period. The initial review period for each submittal package shall be 15 business days. SCDOT reserves the right to return any submittal package that is deficient or incomplete to the extent that it does not comply with Section II, B, 1 and/or does not demonstrate design can be completed in accordance with the Contract. Returned submittals must be revised and uploaded to ProjectWise. Another 15 business day review period will be allowed for resubmittals. SCDOT review comments will be sent to the CONTRACTOR, who shall respond in written form within five business days and prior to subsequent phase submittals. SCDOT will then status CONTRACTOR'S comments and may provide further comments within five business days. If any open comments remain after the 25-day review and comment period, the CONTRACTOR shall respond in written form with no time constraint. SCDOT will status CONTRACTOR'S comments and may provide further comments within five business days. CONTRACTOR shall clearly identify and describe any changes

made to a submittal that are unrelated to SCDOT review comments. Review comments for all phases of each segment or structure shall be closed before the associated RFC plans are approved and prior to commencement of construction, demolition or disposal activities. After comments are closed, any changes made to plans may, at the sole discretion of SCDOT, require a new initial submittal and require adjustment to the CONTRACTOR's submittal schedule. This review and comment is fully discretionary, however no review or comment nor any failure to review or comment shall operate to absolve CONTRACTOR of its responsibility to design and build the Project in accordance with the contract or to shift responsibility to SCDOT.

E. Maintenance of Traffic

The SCDOT work zone mobility requirements found within the documents known as *Rule on Work Zone Safety and Mobility: The Policy for South Carolina Department of Transportation* and *Rule on Work Zone Safety and Mobility: Implementation, Maintenance, and Safety Guidelines* shall apply to this project. These requirements apply to the CONTRACTOR, all subcontractors, all SCDOT staff and designated representatives acting on behalf of the SCDOT performing duties with responsibilities relative to a work zone, including but not limited to planning, project development, design, construction, and maintenance.

The CONTRACTOR shall design, develop, implement and maintain a set of coordinated strategies to manage the work zone impacts of the project designated as the Transportation Management Plan. These strategies will include a Temporary Traffic Control plan, a Transportation Operations component, and a Public Information component. The Policy and the anticipated work zone impacts of the project shall determine the level of detail, content, and scope of the TMP. The primary component, the Temporary Traffic Control plan shall address traffic control and safety throughout and adjacent to the project site. A secondary component, the Transportation Operations plan, will address management of traffic operations in the project site and all adjacent areas impacted by the project. The final component, the Public Information plan, addresses communications with the public and entities impacted by the project. The CONTRACTOR's Transportation Management Plan and its components shall comply with the requirements of this Agreement and subsequent Exhibits, Part 6 of the Manual on Uniform Traffic Control Devices (MUTCD) latest edition, and SCDOT policies, standard specifications and all addendums to the standard specifications, the typical traffic control standard drawings for road construction, and procedures.

F. Ownership of Documents

Drawings, specifications, test data, inspection reports, QC documents, daily diaries and any other documents, including those in electronic form, prepared by CONTRACTOR or CONTRACTOR's consultants are "Project Documents". CONTRACTOR and CONTRACTOR's consultants shall be the owner of the Project Documents. Upon the Effective Date of this Agreement, CONTRACTOR grants

SCDOT a nonexclusive license to reproduce the Project Documents for the purposes of, but not limited to, promoting, using, maintaining, upgrading, or adding to the Project. Upon completion of the Project or upon default by CONTRACTOR, CONTRACTOR shall provide copies of all Project Documents to SCDOT in the format designated by SCDOT.

G. Construction Criteria

CONTRACTOR shall construct the Project in accordance with all applicable Federal, State, and local statutes and regulations. All construction shall be performed in accordance with the following criteria, which are incorporated herein by reference and made a part hereof. The construction criteria are intended to be complementary and to describe and provide for a complete work. Where the following construction criteria conflict, the order of precedence shall be as listed below:

1. **EXHIBIT 4** – Project Design Criteria
2. **EXHIBIT 5** – Special Provisions
3. Final Construction Plans provided by SCDOT
4. SCDOT Standard Drawings, effective as of the most recent Standard Highway Letting prior to the release of the Final RFP ([see Design Build Website - http://www.scdot.org/doing/constructionLetting_DesignBuild.aspx](http://www.scdot.org/doing/constructionLetting_DesignBuild.aspx))
5. SCDOT Supplemental Specifications and Supplemental Technical Specifications, effective as of the release of the Final RFP ([see Design Build Website - http://www.scdot.org/doing/constructionLetting_DesignBuild.aspx](http://www.scdot.org/doing/constructionLetting_DesignBuild.aspx))
6. SCDOT Standard Specifications for Highway Construction, effective as of the release of the Final RFP ([see Design Build Website - http://www.scdot.org/doing/constructionLetting_DesignBuild.aspx](http://www.scdot.org/doing/constructionLetting_DesignBuild.aspx))
7. SCDOT Construction Manual, effective as of the release of the Final RFP
8. SCDOT Approval Sheets, Material Acceptance Policies and New Products Evaluation Summary (available on SCDOT internet website)

H. Project Management

1. CONTRACTOR shall be responsible for ensuring that the Project is constructed in conformance with the Contract, all referenced documents and specifications, and applicable laws and regulations.
2. CONTRACTOR shall provide project management services sufficient to supervise the activities of his own personnel and subcontractors. CONTRACTOR shall provide a sufficient number of persons on site, to the

satisfaction of SCDOT, to provide for the construction management of the Project.

3. SCDOT will provide representatives assigned to the Project to monitor the construction and provide necessary coordination between SCDOT and CONTRACTOR. All costs for salary and equipment to maintain SCDOT employees will be provided by SCDOT at no expense to CONTRACTOR. SCDOT and FHWA, if applicable, representatives will have full and complete access to the Project, the work in progress, the "Daily Diaries", and to other technical documents and project records associated with design, construction, demolition, material disposal, materials, quality control, materials installation, and testing. SCDOT representatives will receive reasonable notice of and have the opportunity to participate in any meetings that may be held concerning the Project or the relationship between CONTRACTOR and their consultants and subcontractors when such meetings are associated with technical matters, progress, or quality of the Project. As used in this paragraph, "notice" shall require actual written notice to SCDOT's Agent.

I. Control of the Work

1. CONTRACTOR shall determine the appropriate means, methods and scheduling necessary to complete the work timely and in accordance with all construction requirements. SCDOT and FHWA, if applicable, will have the right to review and inspect the work at any time.
2. If, at any time, SCDOT observes or has actual notice of any fault or defect in CONTRACTOR's performance of this Agreement, SCDOT will give CONTRACTOR prompt written notice reasonably detailing the nature of the fault or defect. SCDOT is not required to discover or to accept defective or faulty work. SCDOT's right to have defective or faulty work promptly corrected shall not be waived by any action of SCDOT.
3. SCDOT will have the authority to suspend the work, wholly or in part, for such periods, as SCDOT may deem necessary, due to CONTRACTOR's failure to meet the requirements of the Contract in the performance of the work.
4. No inspection, acceptance, payment, partial waiver, or any other action on the part of SCDOT will operate as a waiver of any portion of this Agreement or of any power reserved herein or any right to damages or other relief, including any warranty rights, except insofar as expressly waived by SCDOT in writing. SCDOT will not be precluded or estopped by anything contained herein from recovering from CONTRACTOR any overpayment as may be made to CONTRACTOR.

J. Contract Deliverables

CONTRACTOR shall submit deliverables including, but not limited to, the following as set forth in the CONTRACT. All deliverables shall contain proper references to both the Contract ID number and the appropriate Project ID number for that specific location. Deliverables noted below with an asterisk shall be included in the Design Review Submittal Schedule and follow Design Review procedures as outlined in Section II.D of the Agreement.

1. Contract Deliverable Matrix
2. All deliverables as specified in **EXHIBIT 4***
3. CPM Schedule, as specified in **Article IV**
4. Design Review Submittal Schedule including Gantt Chart of Submittals*
5. Schedule of Values, as specified in **EXHIBIT 2**
6. Design QC Plan*
7. Construction QC Plan
8. Clearing and Grubbing Plan
9. CONTRACTOR's Erosion Control Plan
10. SCDHEC Notice of Intent (NOI) for Stormwater Discharges Covered Under SC NPDES Construction General Permit SCR160000) & Storm Water Pollutant Prevention Plan and signed Contractor Certification Form (SCDHEC 0437)
11. Wetland and Stream Mitigation
12. Crane Operator Documents
13. Community and Public Relations Plan, as specified in **Article X** and **EXHIBIT 5**
14. EEO, DBE, and OJT Requirements, as specified in **Article XVIII & EXHIBIT 5**
15. Right-of-Way documents, as specified in **Article VIII**
16. Escrow Proposal Documents
17. CONTRACTOR's Materials Certification
18. ~~Railroad Coordination Documents & Insurance Certificates per EXHIBIT 6~~
19. HAZMAT surveys for structures not already surveyed, SCDHEC Notice of Demolition for RCE Signature

20. Utility Coordination Reports, including Utility Agreements, and Supporting Documentation
21. Right of Way Plats and Monuments (per Preconstruction Advisory Memorandum #8)
22. Shop Plans and Working Drawings
23. As-Built Plans

III. CONTRACT PRICE/CONTRACT PAYMENTS

A. Contract Price

The “Contract Price” shall be \$_____. In consideration for the Contract Price, CONTRACTOR shall perform all of its responsibilities under the Contract. The Contract Price shall include all work identified in the Agreement and subsequent Exhibits and as identified in the Cost Proposal Bid Form – **EXHIBIT 1**.

B. Contract Price Adjustments

1. Allowable adjustments

The Contract Price may be adjusted to reflect the direct costs, plus an additional amount not to exceed 10% of the direct costs for the combined total of reasonable overhead* and profit, associated with any of the following:

- a. Amount added or deducted as the result of a “Change” or “Construction Change Directive”.
- b. Differing site condition as defined in Article XIII.
- c. Intentional or bad faith acts or omissions by SCDOT that unreasonably interfere with CONTRACTOR’s performance and cause delay of work on the critical path of the Project.
- d. Changes in legal requirements or regulations that are effective subsequent to the date of this Agreement.
- e. Discovery of hazardous materials not previously identified as set forth in Article XI
- f. Discovery of archeological or paleontological sites not previously identified as noted in Article X.
- g. Premium right-of-way costs and second appraisals as set forth in Article VIII. Only the actual premium right-of-way and actual second appraisal cost will be

reimbursed. No additional amount for overhead, profit, bonds and insurance will be considered for this item.

*Overhead: The operating expense of a business exclusive of direct cost labor and material.

Other than as provided above, the Contract Price shall not be increased for contract time adjustments or delay damages. Contract Price adjustments shall be documented by Supplemental Agreement signed by both parties and shall be reflected immediately in the Schedule of Values. No claim by the CONTRACTOR for an adjustment hereunder shall be allowed if notice is not given prior to final payment under this Agreement.

2. Changes

- a. A "Change" shall be any deviation or variation from the Project Scope or the Project Criteria. No Change shall be implemented without the express written approval of SCDOT. A "Change" may be an "Additive Change" or a "Deductive Change".
- b. SCDOT may initiate a change by advising CONTRACTOR in writing of the change. As soon thereafter as practicable, CONTRACTOR shall prepare and forward to SCDOT an estimate of cost or savings, and the impact to the schedule resulting from the change. SCDOT will advise CONTRACTOR in writing of its approval or disapproval of the change via "Issue Paper". If SCDOT approves the change, CONTRACTOR shall perform the Services as changed.

3. Construction Change Directive

A Construction Change Directive is a written order from SCDOT directing a change prior to agreement with CONTRACTOR on adjustment, if any, to the Contract Price or Contract Time. If a price for the work cannot be agreed upon, CONTRACTOR shall perform the work under Force Account Procedures as outlined in Section 109.5 of SCDOT's Standard Specifications.

4. Direct Costs

For the purpose of a Contract Price Adjustment, "Direct Costs" shall be defined as:

- a. Costs of labor, including social security, old age and unemployment insurance, fringe benefits required by agreement or custom, and workers' compensation insurance;
- b. Costs of materials, supplies, and equipment, including cost of transportation, whether incorporated or consumed;

- c. Actual costs of machinery and equipment owned by CONTRACTOR or any affiliated or related entity exclusive of hand tools;
- d. Actual costs paid for rental of machinery and equipment exclusive of hand tools;
- e. Costs of premiums for all bonds and insurance, permit fees, and sales, use or similar taxes;
- f. Additional costs of supervision and field office personnel directly attributable to the change or event; and
- g. Costs incurred or fees paid for design work related to the change or event.

C. Contract Payments

1. Schedule of Values

Prior to execution of this Agreement, CONTRACTOR shall provide a Schedule of Values acceptable to SCDOT and work may not start until the Schedule of Values is approved by SCDOT. The Schedule of Values will serve as the basis for cost loading of the CPM Schedule. The CPM schedule shall include sufficient information to provide for monetary and quantitative tracking of the work by SCDOT. Updates to the cost-loaded CPM schedule will serve as the basis for progress payments requested by and made to CONTRACTOR. If the Contract Price is adjusted, CONTRACTOR shall revise its Schedule of Values and the CPM Schedule to reflect the adjustment in the Contract Price. The revised Schedule of Values must be approved by SCDOT prior to the time for the subsequent request for a progress payment otherwise no progress payments will be made. The Schedule of Values shall be incorporated herein as **EXHIBIT 2**. The Schedule of Values should include Lump Sum items that will serve as measurement and payment for any item referred to in this Contract as a “contract unit bid price” item.

2. Mobilization

Mobilization shall not exceed 5% of the Total Contract Cost as shown in the Schedule of Values. Mobilization will be paid in two (2) equal installments. The first will be paid in the progress payment immediately following Notice to Proceed, and the second will be paid at the start of construction.

3. Periodic Progress Payment Applications

No application for payment of the Contract Price shall be submitted until SCDOT gives a notice to proceed. Applications for payment of the Contract Price may be submitted once a month. Each application for payment of the Contract Price shall set forth, in accordance with the Schedule of Values and the cost-loaded CPM schedule, the percentage of all items comprising the work completed since

CONTRACTOR's immediately prior request for payment. The application for payment of the Contract Price may also request payment for equipment and materials not yet incorporated into the Project, provided that (i) SCDOT is satisfied that the equipment and materials are suitably stored at either the Project or another acceptable location, (ii) the equipment and materials are protected by suitable insurance and (iii) upon payment, SCDOT will receive title to the equipment and materials free and clear of all liens and encumbrances.

4. Periodic Progress Payments

SCDOT will review each application for payment. Upon approval by SCDOT of an application for payment, SCDOT will pay CONTRACTOR the undisputed percentage for the Project completed during the period covered by the application for payment. SCDOT will make each payment within twenty-one (21) days of the receipt of the corresponding Application for Payment. In the event of a dispute over the quality of work or percentage of the Project completed, SCDOT's decision is controlling and final. Payment by SCDOT will not preclude or estop SCDOT from correcting any measurement, estimate, or certificate regarding the percentage completion of the Project, and future payments may be adjusted accordingly.

5. Prompt Payment of Subcontractors

CONTRACTOR shall comply with the requirements of the SCDOT Prompt Payment Clause Supplemental Specification.

6. Withholding of Payment

SCDOT may withhold all or part of any payment under the Contract for any of the reasons listed below. Any funds withheld will be released upon CONTRACTOR satisfactorily remedying the defect, fault, or failure and will be included in the next regularly schedule pay estimate. Payment will be subject to retainage if applicable.

- a. Defective work not remedied. Any such withholding, however, shall not exceed two times the reasonable cost of remedying the defective work. Defective work shall be defined as work or material not conforming to the requirements of the Contract.
- b. Reasonable evidence that the Work will not be Substantially Complete within the Contract Time as adjusted and that the unpaid balance of the Contract Price will not be adequate to cover Liquidated Damages for the actual unexcused delay;
- c. Failure to comply with the prompt payment provision of this Contract;
- d. Any fines or other charges to SCDOT due to CONTRACTOR's failure to comply with permit requirements or other regulations;

- e. Notice of cancellation of insurance;
- f. Failure to submit updated and approved CPM or Schedule of Values;
- g. Violation of QC plan requirements;
- h. Failure to follow specifications or procedures required by the Contract;
- i. Failure to comply with DBE, On-The-Job training, or Pre-Employment Training provisions;
- j. Failure to provide adequate work zone traffic control;
- k. Failure to provide adequate sediment and erosion control; or,
- l. Violation of any contract provisions.

D. Retainage

Provided the Project is proceeding satisfactorily, SCDOT will not withhold retainage. However, if at any time SCDOT determines that CONTRACTOR fails to meet contract terms or the Project is not proceeding satisfactorily, SCDOT may retain up to 10% of the Contract Price as retainage.

IV. CONTRACT TIME

A. Project Schedule

1. Time for Completion of Project: **Time is of the essence.** The Project shall be **S**ubstantially **C**ompleted by **November 12, 2021**. The Notice to Proceed shall be no later than 45 days from the effective date of the Agreement. Final Completion shall be reached as defined in paragraph 5 below.

Contract Time shall be the number of calendar days from Notice to Proceed to Substantial Work Completion plus the time from Substantial Work Completion to Final Completion.

2. Substantial Work Completion: The Project shall be considered substantially complete when it is serviceable to the public, all lanes and ramps are open, and all work is completed except for "Project Close-out Activities", "Project Close-out Activities" are defined as punch list items, site clean-up, demobilization, and final Project documentation, including but not limited to as-built plans.
3. Critical Path Method Schedule: CONTRACTOR shall prepare and maintain a schedule for the Project using the Critical Path Method of scheduling (hereinafter called "CPM Schedule"). Prepare a Level II CPM Schedule in accordance with this agreement and the SCDOT Supplemental Specifications with the following exceptions:

- a. Submit to the SCDOT the initial baseline CPM schedule within 30 days from the Effective Date of this Agreement. No contract payment will be made to Contractor and no construction work may begin until a CPM baseline schedule is received and accepted by SCDOT. Update the baseline CPM schedule for monetary and quantitative tracking purposes as Released for Construction plans are developed.
- b. Cost-load the CPM schedule using the expenses identified in the schedule of values. Use the schedule of values to establish Expense Categories and assign to the correct activities.
- c. Include submittal activities. Allow duration for these activities to include SCDOT review periods.
- d. Reuse of deleted activity ID's from schedule update to schedule update is not allowed.
- e. Failure to include any element of work or any activity including but not limited to utility relocation, right of way acquisition, and permitting will not relieve the CONTRACTOR from completing all work within the Contract Time at no additional time or cost to the SCDOT, notwithstanding the acceptance of the schedule by SCDOT.
- f. Develop project specific calendars reflecting all seasonal restrictions included in this Agreement and non-work days. Address durations for weather within activity duration, not within the calendar.
- g. Use only a Work Breakdown Structure (WBS) to organize schedule activities. At a minimum, breakout the design and construction phases. These two breakouts should have the same parent within the structure.
- h. Submit monthly updates no later than 15 days following the most recent estimate period end date, whether or not an estimate was generated. Set the data date the same as the most recent estimate period end date.
- i. If SCDOT determines any schedule submission is deficient, it will be returned to the CONTRACTOR. A corrected schedule shall be provided within 7 calendar days from the SCDOT's transmittal date.
- j. The schedule may indicate an early completion date. However, SCDOT will not be liable in any way for CONTRACTOR's failure to complete the Project prior to the specified Contract Time. Any additional costs, including extended overhead incurred between CONTRACTOR's scheduled completion date and the Contract Time, shall be the responsibility of the CONTRACTOR.
- k. The schedule may include constraints to indicate the early completion of portions of the work. SCDOT will remove these constraints when determining the critical path of the schedule.

1. Include in each narrative a detailed listing of crews utilized on activities and their responsibilities. In lieu of this, the Contractor may request to submit a Resource Loaded CPM schedule.
4. Progress Review Meetings:
- a. Review Meetings shall be held between CONTRACTOR and SCDOT at least every 2 weeks. Periodic construction meetings shall be held by CONTRACTOR with its consultants and subcontractors to coordinate the work, update the schedule, provide information and resolve potential conflicts.
 - b. SCDOT and CONTRACTOR will hold a regular CPM Progress Meeting at which all principal parties are expected to attend. These meetings will be held the week before the application for payment is due so that job progress will coincide with the payment application. At this meeting, CONTRACTOR shall provide the most recent schedule with notations showing actual start dates, actual finish dates, and activity progress. If the schedule provided indicates an actual or potential delay to the completion of the Contract, CONTRACTOR shall provide a narrative identifying the problems, causes, the activities affected and describing the means and methods available to complete the Project by the Contract Time.
5. Final Completion: When CONTRACTOR believes that all elements of its work on the Project, including all of the requirements of the Contract, have been completed, it shall notify SCDOT in writing. Final Completion shall be achieved within 180 calendar days of Substantial Work Completion as defined in this Agreement. Within thirty (30) days thereafter, SCDOT will acknowledge project completion or will advise CONTRACTOR in writing of any aspect of the Contract or the Project Scope that is incomplete or unsatisfactory. CONTRACTOR shall complete all corrective action within thirty (30) days after written notification of incomplete or unsatisfactory items. CONTRACTOR will notify SCDOT in writing upon completion of necessary corrective action. SCDOT will verify satisfactory completion of the corrective action in writing to CONTRACTOR. Upon verification, the Project shall be deemed to have achieved Final Completion.
6. Inspection/Acceptance; No Waiver: No inspection, acceptance, payment, partial waiver, or any other action on the part of SCDOT will operate as a waiver of any portion of this Agreement or of any power reserved herein or any right to damages or other relief, including any warranty rights, except insofar as expressly waived by SCDOT in writing. SCDOT will not be precluded or estopped by anything contained herein from recovering from CONTRACTOR any overpayment as may be made to CONTRACTOR.

B. Contract Time Adjustments

The Contract Time may be extended if there is a delay to the critical path of the Project caused by an event listed below. All requests for time extensions shall be made in writing to SCDOT within 20 days of the event causing the delay. All time extensions must be approved in writing by SCDOT. Time extensions may be allowed for the following events that affect the critical path:

1. Force Majeure as that term is defined in this Agreement in Article XIV;
2. Changes or construction change directives;
3. Differing site conditions as defined under Article XIII;
4. Injunctions, lawsuits, or other efforts by individuals or groups that hinder, delay, or halt the progress of the Project, provided that such efforts are not premised on alleged wrongs or violations by CONTRACTOR or its subcontractors;
5. Interference with or delay of work on the critical path of the Project by SCDOT; however, CONTRACTOR shall not be entitled to a time extension if SCDOT's actions are necessitated by CONTRACTOR's actions, omissions, failure to perform quality work, or failure to comply with contract requirements;
6. Changes in the legal requirements or regulations which are effective subsequent to the date of this Agreement;
7. Discovery of hazardous materials not previously identified as set forth in Article XI;
8. Discovery of archeological or paleontological remains not previously identified as set forth in Article X; or
9. Adverse utility relocation impacts meeting the requirements set forth in Article VII.
10. Adverse Railroad coordination impacts as set forth in Article VII.
11. Adverse permit acquisition impacts as set forth in Article IX.

C. Owner's Right to Stop Work

SCDOT will have the authority to suspend the work, wholly or in part, for such periods, as SCDOT may deem necessary, due to CONTRACTOR's failure to meet the requirements of the Contract in the performance of the work. Such suspension of the work shall not constitute grounds for claims for damages, time extensions, or extra compensation.

D. Liquidated Damages

CONTRACTOR shall pay liquidated damages to SCDOT in the amount of Ten Thousand Dollars (\$10,000.00) for each day for which construction is not substantially complete, as defined in Article IV.

CONTRACTOR shall pay liquidated damages to SCDOT in the amount of One Thousand Eight Hundred Dollars (\$1,800.00) for each day that Final Completion, as defined in Article IV, is not achieved.

The parties acknowledge, recognize and agree that because of the unique nature of the Project, it is difficult or impossible to determine with precision the amount of damages that would or might be incurred by SCDOT as a result of the CONTRACTOR's failure to complete the Project as specified in the Contract. Therefore, any sums payable under this provision are in the nature of liquidated damages, and not a penalty, and are fair and reasonable and such payment represent a reasonable estimate of fair compensation for the losses that may reasonably be anticipated from such failure. Notwithstanding the above, liquidated damages are not intended to excuse the CONTRACTOR from liability for any other breach of its obligations under the Contract.

V. QUALITY ASSURANCE PROGRAM

A. CONTRACTOR's Responsibilities

CONTRACTOR shall be responsible for the QUALITY CONTROL Portion of the Program to include the items listed below. Work shall not commence until CONTRACTOR has met these requirements.

1. Quality Control Plan: CONTRACTOR shall submit a Quality Control (QC) Plan that outlines how CONTRACTOR shall assure that the materials and work are in compliance with the contract documents. The initial plan shall be submitted to SCDOT for review and approval at least five (5) business days prior to any design or plan submittal or the beginning of any construction activity. The plan shall be updated as necessary prior to the start of any specific construction operation. The plan shall include a list of SCDOT certified personnel responsible for management and quality control of the Project, and define the authority of each individual. The plan shall also include how CONTRACTOR will monitor quality and deal with failing materials. The QC Plan shall include the QC testing and sampling frequencies and shall indicate the frequency at which the QC Manager will provide QC test results to SCDOT. CONTRACTOR shall include an estimated summary of quantities to SCDOT for the purposes of meeting the minimum sampling and testing requirements in accordance with the SCDOT Construction Manual.
2. Personnel: CONTRACTOR shall provide a sufficient number of SCDOT certified personnel to adequately control the work of the Project. Any personnel

required to obtain samples or conduct material testing shall be SCDOT certified. CONTRACTOR shall provide SCDOT with copies of each individual's certifications for review and approval by SCDOT. Approved CONTRACTOR QC personnel shall be on the job at all times that permanent work items and materials are being incorporated into the project. CONTRACTOR's QC personnel shall not have any other project responsibilities.

3. CONTRACTOR Testing: CONTRACTOR is required to conduct asphalt sampling and testing in accordance with the SCDOT Standard Specifications and the SCDOT Supplemental Technical Specifications SC-M-400. CONTRACTOR shall conduct sampling and testing to ensure that all workmanship and materials are in compliance with the contract requirements. Although not used for acceptance, QC testing and inspection shall ensure that quality has been incorporated into all elements of work prior to requesting acceptance testing and inspection. The QC Program should be sufficient in scope to remedy repeated discoveries of non-compliant work by those performing acceptance inspection and testing. Repeated observations of QC quality shortfalls shall be considered a breakdown of the QC program and shall be cause for investigation and corrective action prior to commencement of work areas affected. Corrective action may include the addition of new QC procedures, revision to existing QC procedures, re-training of QC personnel, removal and replacement of QC personnel, or other such actions which will restore the effectiveness of the QC program. All QC testing shall be performed in accordance with existing AASHTO, ASTM, or test methods used by SCDOT. The cost of these activities will be borne by CONTRACTOR. Additionally, CONTRACTOR is responsible for dynamic and static load testing of drilled shafts and piles in accordance with the requirements of **EXHIBITS 4 and 5**.
4. Testing Laboratories: All testing laboratories used on the Project must be AASHTO certified and approved by SCDOT thirty (30) days prior to beginning the portion of work for which the laboratory will be performing the testing. Hot Mix Asphalt testing laboratories require SCDOT certification.
5. Mix Designs: Copies of all initial hot-mix asphalt mix designs and Portland Cement Concrete mix designs, along with supporting data, shall be submitted to SCDOT for review at least five (5) business days prior to use. All hot-mix asphalt mix designs will be prepared by personnel certified in Mix Design Methods. Portland Cement Concrete mix designs will be prepared by a certified concrete technician or a Professional Engineer. The Portland Cement Concrete mix proportions given in the specifications are to be followed. CONTRACTOR shall design the mix to obtain the strength and water/cement ratios given in the specifications, and shall provide workability, air content, gradation and suitable set times as set forth in the Standard Specifications. The SCDOT will be notified of any revisions to CONTRACTOR's mix design. Copies of such revisions will be sent to SCDOT for review at least ten (10) business days prior to use.

6. Materials Certifications: CONTRACTOR's QC Manager shall submit all material certifications to SCDOT prior to the CONTRACTOR incorporating the material into the project.

B. SCDOT Responsibilities

SCDOT will be responsible for the QUALITY ACCEPTANCE portion of the program to include: conducting inspections, acceptance testing, independent assurance testing and final project material certification.

1. Acceptance Testing: SCDOT personnel assigned to the Project, or qualified personnel retained by SCDOT, will conduct sampling and testing, separate from CONTRACTOR's testing, at the frequencies set forth in SCDOT's construction manual. This testing will be used by SCDOT to determine the acceptability of the materials. All sampling and testing will be in accordance with existing AASHTO, ASTM, or SC test methods used by SCDOT. The cost of these activities will be borne by SCDOT. CONTRACTOR's QC Manager is required to coordinate all activities closely with SCDOT to allow the necessary acceptance testing to be conducted prior to proceeding to the next operation. The disposition of failing materials must be approved by SCDOT.
2. Independent Assurance Testing: SCDOT will be responsible for conducting Independent Assurance Testing. Personnel performing these tests will be SCDOT employees or qualified persons retained by SCDOT. Persons performing these tests will not be involved in Acceptance Testing. This testing will be used to ensure that proper sampling and testing procedures are being followed, and that testing equipment is functioning properly. This testing will consist of observing sampling and testing by both SCDOT personnel performing Acceptance Testing and CONTRACTOR personnel performing Quality Control Testing, as well as taking split samples for the purposes of comparison testing. Independent Assurance Testing will be at an approximate frequency of one-tenth of the Acceptance Testing frequency. Independent Assurance test results will not be used for acceptance. The cost of these activities will be borne by SCDOT.
3. Materials Certification: SCDOT will be responsible for preparing the Materials Certification as required by the FHWA on federally funded projects.

C. CONTRACTOR's Obligation

SCDOT's testing in no way relieves CONTRACTOR of its obligation to comply with the Contract requirements. All materials incorporated into the Project must meet or exceed contract requirements and specifications. Further, any testing by SCDOT will not relieve CONTRACTOR of any of its warranty obligations.

VI. INSURANCE AND BONDING

A. Insurance

1. CONTRACTOR shall purchase and maintain insurance using a company or companies that maintain an A.M. Best rating of not less than A-VII with coverage forms acceptable to SCDOT. The insurance described below shall be maintained uninterrupted for the duration of the Project, including warranty periods, and shall protect CONTRACTOR from claims set forth below which may arise out of or result from CONTRACTOR's operations under the Contract, whether such operations be performed by CONTRACTOR or by any subcontractor or by anyone directly or indirectly employed by any of them or by anyone for whose acts any of them may be liable:
 - a. Claims under workers' or workmen's compensation, disability benefit and other similar employee benefit acts;
 - b. Claims for damages because of bodily injury, occupational sickness or disease, or death of CONTRACTOR's employees;
 - c. Claims for damages because of bodily injury, sickness or disease, or death of any person other than CONTRACTOR's employees;
 - d. Claims for damages insured by usual personal injury liability coverage which are sustained (1) by any person as a result of an offense directly or indirectly related to the employment of such person by CONTRACTOR, or (2) by any other person;
 - e. Claims for damages, other than to the work itself, because of injury to or destruction of tangible property, including loss of use resulting therefrom;
 - f. Claims for damages because of bodily injury or death of any person or property damage arising out of the ownership, maintenance or use of any motor vehicle.
 - g. Claims involving contractual liability insurance applicable to the Contractor's obligations under the indemnity provisions of this contract.
2. The minimum limits of liability for the following types of insurance are required, except where greater limits are required by statute:
 - a. Workers' Compensation, including: Worker's Compensation Insurance/Employer's Liability

State Statutory limits

Employer's Liability
\$100,000 per accident
\$500,000 per disease
\$100,000 each employee

deductible at the time of the execution of the agreement and for every year thereafter until the insurance obligation ends.

4. Limits shown in this provision are minimum acceptable limits and in no way limit available coverage to the additional insured. CONTRACTOR's CGL and commercial umbrella policies shall contain no provision providing that the limits available to an additional insured are less than the limits available to the CONTRACTOR. SCDOT shall be given all the same rights and insurance coverage as CONTRACTOR. In the event that any insurer issues a reservation of rights for SCDOT as an additional insured, SCDOT shall be entitled to employ independent counsel, of its choice, at CONTRACTOR's expense.
5. There shall be no endorsements or modifications of the CGL limiting the scope of coverage for liability arising from explosion, collapse, underground property damage or work performed by contractors on behalf of SCDOT.
6. Hazardous Materials: If the CONTRACTOR is required to remove and haul any hazardous waste from the Project, or if the Project involves such similar environmental exposure, pollution liability coverage equivalent to that provided under the ISO Pollution Liability – Broadened Coverage for Covered Autos Endorsement (CA 99 48), shall be provided, and the Motor Carrier Act Endorsement (MCS 90) shall be attached. Limits of pollution liability shall be not less than \$250,000 per occurrence. Coverage shall apply on an “occurrence form” basis, shall cover at a minimum bodily injury, property damage, defense costs and clean-up costs and be extended to include non-owned disposal sites and transportation coverage. This insurance shall remain in effect after acceptance by Owner for the time period required to satisfy the statute of limitations in South Carolina. However, if coverage is written on a “claims made form”, then the Contractor's Pollution Liability coverage shall include a retroactive date that precedes the commencement of work under this Agreement. Such coverage shall apply as primary and non-contributory insurance with respect to any other insurance or self-insurance programs, including any deductibles, afforded to, or maintained by SCDOT.
7. Waiver of Subrogation: CONTRACTOR shall waive its rights against SCDOT, other additional insured parties, and their respective agents, officers, directors and employees for recovery of damages, or any other claims, to the extent these damages are covered by the CGL, business auto, pollution liability, workers compensation and employer's liability or commercial umbrella maintained pursuant to this section of the Agreement.
8. CONTRACTOR shall at the time of execution of this Agreement, obtain or require the Lead Designer to obtain, Errors and Omissions insurance for their Professional Liability, for all claims arising from the performance of professional services on the Project. The insurance coverage shall be for not less than \$1,000,000 per claim and in the aggregate. The coverage shall be continued for three (3) years after the date of Final Completion of the Project. Evidence of such

insurance shall be provided to SCDOT at the time of the execution of the Agreement.

9. After Final Completion of the work, CONTRACTOR shall maintain CGL and commercial umbrella coverage to include liability coverage for damage to insured's completed work equivalent to that provided under ISO CG 00 01 for three (3) years or for the statute of limitations period for damages, whichever is greater.
10. By execution of the contract, the CONTRACTOR accepts the responsibility to provide the liability insurance policies and endorsements as specified herein. Failure of SCDOT to identify a deficiency in the Certificate of Insurance submitted by the CONTRACTOR's insurance agent as evidence of the specified insurance or to request other evidence of full compliance with the liability insurance specified shall not be construed as a waiver of the CONTRACTOR's obligation to provide and maintain the required insurance for the duration of the contract.
11. CONTRACTOR shall provide "Builders Risk Insurance" acceptable to the SCDOT in the amount of the Contract Price protecting the respective interests of SCDOT and CONTRACTOR and covering physical loss or damage to the work during construction of the Project. The certificate of insurance shall be provided to the SCDOT at the time of execution of this Agreement. The CONTRACTOR shall also obtain **\$5,000,000.00** in Delay in Start Up Coverage under the Builder's Risk policy. The policy shall name the SCDOT as an additional insured and shall reference the Project by name. The certificate shall also state that the coverage will not be cancelled or reduced without 30 days prior written notice to the SCDOT.

B. Bonding

1. CONTRACTOR shall at the time of the execution of this Agreement, provide SCDOT the following bonds:
 - a. A Performance and Indemnity Bond from a surety or sureties satisfactory to SCDOT. The amount of bond shall be equal to the Contract Price.
 - b. A Payment Bond from a surety or sureties satisfactory to SCDOT. The amount of bond shall be equal to the Contract Price.

These bonds shall be in accordance with the requirements of S.C. Code Ann. §57-5-1660, (1976 as amended) and S.C. Code Ann. §29-6-250 (2000). Bonds shall be issued by a surety company licensed in the State of South Carolina with an "A" minimum rating of performance as stated in the most current publication of "A.M. Best Key Rating Guide, Property Liability" and signed by the surety's agency or attorney-in-fact. Surety must be listed on the current U.S. Department of the Treasury Financial Management Service list of approved bonding companies as

approved for an amount equal to or greater than the amount for which it obligates itself in the Bond. If surety qualifies by virtue of its Best's listing, the amount of the Bond may not exceed ten percent of policyholders' surplus as shown in the latest A.M. Best's Key Rating Guide.

2. CONTRACTOR shall also provide a warranty bond, acceptable to SCDOT, in the amount of \$500,000 to cover the warranty obligations of the contract.

VII. UTILITIES AND RAILROAD COORDINATION

- A. As part of the Project Scope, CONTRACTOR shall have the responsibility of coordinating the Project construction and demolition activities with all utilities that may be affected. CONTRACTOR shall be responsible for the cost of all utility coordination unless defined otherwise herein. If applicable, all temporary relocation costs as well as any other conflict avoidance measures shall be the responsibility of the CONTRACTOR. For those utilities that have prior rights SCDOT will be responsible for permanent relocation costs as defined by the Federal code. For those utilities where the CONTRACTOR determines that the SCDOT has prior rights, CONTRACTOR may exercise these rights and require the utility company to bear the costs of relocation. If there is a dispute over prior rights, SCDOT shall be responsible for resolving the dispute. SCDOT shall have final determination of the utility's prior rights.
- B. For those utilities requiring relocation, CONTRACTOR shall conform with SCDOT's "A Policy for Accommodating Utilities on Highway Rights of Way", the applicable State laws, and the Code of Federal Regulations, Title 23, Chapter 1, Subchapter G, part 645, subparts A and B. The CONTRACTOR is responsible for all costs associated with relocating utilities owned by SCDOT.
- C. The resolution of any conflicts between utility companies and the construction of the Project shall be the responsibility of the CONTRACTOR. If said utility companies interfere or fail to relocate conflicting utilities in a timely manner, SCDOT may, on an individual basis, consider a time extension for utility company delays when CONTRACTOR can demonstrate that appropriate coordination efforts have been made to expedite the utility relocation, and that the delay has a direct impact on the approved Critical Path. CONTRACTOR shall not be entitled to additional compensation for interference or delays in utility relocations. CONTRACTOR shall meet with the Department's Utilities Office within thirty (30) days of the Notice to Proceed to gain a full understanding of what is required with each utility submittal.
- D. CONTRACTOR shall design the Project to avoid conflicts with utilities where possible, and minimize impacts where conflicts cannot be avoided. If there is a dispute between the CONTRACTOR and SCDOT as to whether a utility relocation is required, SCDOT shall have the final determination. Additional utility relocations desired by the CONTRACTOR for but not limited to construction staging, access or convenience, shall be the sole responsibility of CONTRACTOR and all associated costs shall be borne by the CONTRACTOR.

- E. CONTRACTOR shall initiate early coordination with all utilities and provide the utility companies with design plans for their use in developing Relocation Sketches as soon as the plans have reached a level of completeness adequate to allow the companies to fully understand the Project impacts. If a party other than the utility company prepares Relocation Sketches, there shall be a concurrence box on the plans where the utility company signs and accepts the Relocation Sketches as shown.
- F. CONTRACTOR shall be responsible for collecting and submitting to SCDOT the following from each utility company that is located within the project limits:
1. **Relocation Sketches** including letter of “no cost” where the company does not have a prior right;
 2. **Utility Agreements** including documentation of prior rights, cost estimate and relocation plans where the company has a prior right; and/or
 3. **Letters of “no conflict”** where the company’s facilities will not be impacted by the Project. Include location sketches on SCDOT plans confirming and certifying that facilities are not in conflict.
 4. **Encroachment Permits** for all relocations regardless of prior rights.
- G. CONTRACTOR shall assemble the information included in the Utility Agreements and Relocation Sketches in a final and complete form and in such a manner that the Department may approve the submittals with minimal review. CONTRACTOR shall ensure that there are no conflicts with the proposed highway improvements, or between each of the utility company’s relocation plans. CONTRACTOR may not authorize the utility companies to begin their relocation work until authorized in writing by SCDOT. Any early authorization by CONTRACTOR shall be at the CONTRACTOR’s risk.
- H. At the time that CONTRACTOR notifies SCDOT that CONTRACTOR deems the Project to have reached Final Completion, CONTRACTOR shall certify to SCDOT that all utilities have been identified and that those utilities with prior rights or other claims related to relocation or coordination with the Project have been relocated or their claims otherwise satisfied or will be satisfied by CONTRACTOR.
- I. CONTRACTOR shall accurately show the final location of all utilities on the as-built drawings for the Project. SCDOT reserves the right to request CADD files as needed.

If Railroad property is impacted by this project, the following provisions shall apply:

- J. Under the direction of and in coordination with SCDOT, the CONTRACTOR shall be responsible for all coordination with the involved Railroad Companies, including but not limited to, sending plans, meetings, correspondence, phone calls, writing/reviewing agreements, and etc. as may be necessary to secure the applicable executed railroad agreements, needed for the construction of the project, between the

SCDOT and all involved Railroad Companies. All correspondence related to railroad agreements or conditions shall include the railroad file number and railroad milepost information. The CONTRACTOR shall be responsible for the cost of railroad coordination as defined herein.

- K. SCDOT will submit for approval, all required railroad agreements necessary for the Preliminary Engineering and Construction of the project. Upon approval, the SCDOT will submit the agreement to the Railroad Company for execution. The CONTRACTOR shall be responsible for assisting SCDOT in the development of the railroad agreement by providing requested information.
- L. The CONTRACTOR shall be responsible for all costs to the Railroad Company or Companies for services provided by the Railroad or the Railroad's Agent, as detailed in the executed Railroad Agreement between the SCDOT and the Railroad. This includes all expenses such as railroad flagging operations. The CONTRACTOR shall be responsible for all other costs associated with designing and constructing the project as described in the executed Railroad Agreement between the SCDOT and the Railroad Company. The CONTRACTOR shall include all costs associated with these requirements in the final bid price. Once a contract is executed, SCDOT shall administer invoicing for costs to the Railroad Company or Companies. Monies will be deducted from the CONTRACTOR's progress payments after payments are made to the Railroad Company.
- M. All design and construction activities in, adjacent to, over or under the railroad shall comply with all applicable Federal and State laws and standards, all terms identified in the Special Provisions for Protection of Railway Interests, and all terms of the final agreement executed with the Railroad Company.
- N. The CONTRACTOR shall be required to meet the Railroad's Insurance Requirements as specified in the Special Provisions for Protection of Railway Interests.
- O. The CONTRACTOR shall attend a mandatory meeting with the SCDOT's Utilities Office and Railroad Projects Office within thirty (30) days after the Notice to Proceed. The CONTRACTOR shall use the SCDOT approved agreement language and procedures, that will be provided in this meeting.
- P. CONTRACTOR shall provide project specific information to SCDOT for inclusion into the agreements. The CONTRACTOR shall anticipate and include in the proposed schedule a minimum 90-day approval time-frame for all railroad agreements. If said Railroad Companies interfere or fail to provide information in a timely manner, SCDOT may, on an individual basis, consider a time extension for Railroad Company delays when CONTRACTOR can demonstrate that appropriate coordination efforts have been made to expedite the railroad coordination, and that the delay has a direct impact on the approved Critical Path. CONTRACTOR shall not be entitled to additional compensation for interference or delays related to railroad coordination.

- Q. CONTRACTOR shall anticipate the need for a separate right-of-entry agreement between the CONTRACTOR and Railroad for surveys, borings, etc. The required PE Agreement, between SCDOT and Railroad, must be executed before Railroad will review or comment on any design questions or submittals from the CONTRACTOR. The Construction Agreement, between SCDOT and Railroad, must be executed before any construction activities can begin at the railroads.
- R. CONTRACTOR is advised that all utility relocations required within railroad right-of-way will require separate agreements between the affected utility company and the Railroad.

VIII. RIGHT OF WAY ACQUISITION

A. Right of Way Services

CONTRACTOR, acting as an agent on behalf of the State of South Carolina, shall provide right-of-way services for the Project unless otherwise directed herein. CONTRACTOR shall use firm(s) from the SCDOT's current "on-call" list for right of way consultants, to provide right of way services. Right-of-way services shall include appraisal, appraisal review, negotiation, acquisition, and relocation assistance services. CONTRACTOR shall be responsible for all costs related to these right-of-way services. CONTRACTOR will provide expert testimony and SCDOT will provide legal services necessary for any cases that are to be resolved by trial. Experts are defined as engineering and appraisal witnesses. SCDOT will retain final authority for approving just compensation, relocation benefits and settlements. SCDOT will designate a hearing officer to hear any Relocation Assistance Appeals. SCDOT agrees to assist with any out of state relocation by persons displaced within the rights of way by arranging with such other state(s) for verification of the relocation assistance claim. CONTRACTOR shall carry out the responsibilities as follows:

1. Acquire property in accordance with all Federal and State laws, guidelines, and regulations, including but not limited to the Uniform Relocation and Real Property Acquisition Act of 1970, as amended (the "Uniform Act"), the SCDOT Acquisition Manual, the SCDOT Appraisal Manual, SCDOT Relocation Manual, and the South Carolina Eminent Domain Procedure Act ("The Act"). CONTRACTOR shall not be entitled to an increase in the Contract Price for acquisition of borrow sources.
2. Submit procedures for handling right-of-way acquisitions and relocations to the SCDOT for approval prior to commencing right-of-way activities. These procedures are to show CONTRACTOR'S method including the appropriate steps and workflow required for appraisal, acquisition, and relocation. CONTRACTOR shall be granted the authority for administrative settlements by the SCDOT's Right-of-Way Office upon review and approval of the Right-of-Way Procedures. These procedures should also include an appropriate time allowance for SCDOT to establish just compensation, approve relocation benefits, and approve administration and legal settlements. A SCDOT Representative will

be available to make timely decisions concerning establishing just compensation, approving relocation benefits, and approving administrative settlements on behalf of SCDOT. The SCDOT Representative is committed to issuing decisions on approval requests within three (3) business days. The commitment is based on the procedure providing a reasonable and orderly workflow and the work being provided to the SCDOT Representative as completed.

3. Utilize SCDOT's right-of-way project tracking system and provide an electronic status update a minimum of twice per month or upon request by SCDOT's representative.
4. As part of the right-of-way acquisitions and relocation procedures, include a right-of-way quality control plan to the SCDOT for review prior to commencing right-of-way activities. SCDOT standard forms and documents will be used to the extent possible.
5. Provide a toll free telephone number for landowners and displaced persons to call and an office near the Project which is located within the State of South Carolina for the duration of the right of way acquisition and relocation services for this Project.
6. Provide a current title certificate by a licensed South Carolina attorney for each parcel within ninety (90) days of the date of closing or the date of filing of the Condemnation Notice.
7. Prepare appraisals in accordance with the Department's Appraisal Manual. Appraisals shall be prepared by appraisers who are on the SCDOT approved list of active fee appraisers.
8. Provide appraisal reviews complying with technical review guidelines of SCDOT Appraisal Manual and make a recommendation of just compensation. The reviewer shall be from the SCDOT's approved reviewer list.
9. Make direct payments of benefits to property owners for negotiated settlements, relocation benefits and payments to be deposited with the court and notify SCDOT monthly of payments made.
10. Prepare, obtain execution of, and record documents conveying title to such properties to SCDOT with Register of Deeds, and deliver all executed and recorded general warranty deeds to SCDOT. For all property in conjunction with the Project, title will be acquired in fee simple (except that SCDOT may in its sole discretion direct the acquisition of a right-of-way easement or permissions, in lieu of fee simple title, with respect to any portion of the Rights of Way) and shall be conveyed to "The South Carolina Department of Transportation" by general warranty deed, free and clear of all liens and encumbrances except permitted encumbrances.

11. Because these acquisitions are being made as agent on behalf of the State of South Carolina, SCDOT shall make the ultimate determination in each case as to whether settlement is appropriate or whether the filing of a condemnation action is necessary, taking into consideration the recommendations of the CONTRACTOR. When SCDOT authorizes the filing of a condemnation, CONTRACTOR shall prepare a Notice of Condemnation in the name of SCDOT, and submit it to SCDOT for SCDOT to file and serve appropriate condemnation documents and pleadings, and request priority status pursuant to S.C. Code Ann. Section 28-2-310(1976, as amended).
12. SCDOT shall prosecute condemnation proceedings to final judgment pursuant to the requirements of the South Carolina Eminent Domain Procedures Act. The procedure shall be by way of trial as provided by Section 28-2-240 of "The Act". SCDOT shall be responsible for obtaining legal representation and CONTRACTOR will be responsible for providing expert witnesses, necessary for condemnation actions. All settlements of condemnation cases shall be at SCDOT's sole discretion.
13. CONTRACTOR will be responsible for all contacts with landowners for rights-of-way or construction items and shall provide the following:
 - a. All Notices of Condemnation, issued pursuant to the authority granted, all titles of real estate and all right of way easements, recorded with the Office of the Register of Deeds or the Clerk of Court for the county or counties in which properties acquired through condemnation are located;
 - b. All drainage permissions, slope permissions, Right of Entry agreements, and releases;
 - c. A right-of-way agent's worksheet, or documents substantially in the format of SCDOT Form No. 809, for each tract.
14. CONTRACTOR shall provide a right-of-way certification and SCDOT shall approve that certification prior to CONTRACTOR entering the property. Only in exceptional circumstances will a certification be approved based on a right of entry. Certification may be on a tract-by-tract basis.
15. If after right of entry Certifications have been submitted there remains outstanding remaining tracts that have not been resolved, CONTRACTOR shall exercise care in its operations when working in proximity to adjacent developed properties, properties not yet acquired, and residences or businesses that are to be relocated. CONTRACTOR shall submit a plan to the SCDOT's right-of-way representative for approval to:
 - a. Establish a clear zone adjacent to properties occupied by persons to be displaced in which construction equipment may not be operated or parked,

- b. Establish a clear zone for construction for properties occupied by persons to be displaced to prevent undue impacts or hardships,
 - c. Establish a method of protecting equipment from vandalism or unauthorized use,
 - d. Perform all burning in accordance with applicable laws and ordinances, with specific attention to SCDHEC's Bureau of Air Quality Control criteria which require compliance with the South Carolina Air Pollution Control laws, regulations, and standards as they concern the related work included in the Contract.
 - e. Provide reasonable and safe access to residences or businesses that are to be displaced until such time as the property is vacant, and
 - f. Observe the property rights of landowners of adjacent and/or yet to be acquired properties.
16. CONTRACTOR shall use reasonable care in determining whether there is reason to believe that property to be acquired for rights-of-way may contain concealed or hidden wastes or other materials or hazards requiring remedial action or treatment. When there is reason to believe that such materials may be present, CONTRACTOR shall take steps consistent with customary industry standards to investigate. SCDOT shall be notified of the presence of such materials before an offer is made to acquire the property.
17. During the acquisition process and for a period of three years after final payment is made to CONTRACTOR for any phase of the work, all project documents and records not previously delivered to SCDOT, including but not limited to design and engineering costs, construction costs, costs of acquisition of rights-of-way, and all documents and records necessary to determine compliance with the laws relating to the acquisition of rights-of-way and the costs of relocation of utilities, shall be maintained and made available to SCDOT for inspection or audit.

B. Acquisition of Right-of-Way

- 1. The CONTRACTOR is responsible for verification of all information necessary for acquisition of the Right-of-Way (ROW) and is responsible for all costs, excluding premium cost as defined below, associated with the purchase of the Right-of-Way. The CONTRACTOR shall acquire the property as an agent on behalf of the State of South Carolina.
- 2. Acquisition of any additional area (not right of way) desired by the CONTRACTOR for, but not limited to, construction staging, access or borrow pits, shall be the sole responsibility of CONTRACTOR, and any title or interest shall be secured in the name of the CONTRACTOR. CONTRACTOR shall provide SCDOT the location and documentation for these additional areas. CONTRACTOR shall furnish SCDOT a copy of any agreements, whether for

purchase or lease, for the use of additional properties in conjunction with the construction of the Project. CONTRACTOR shall abide by the provisions of all applicable environmental permits, any conditions of individual right of way agreements, and all environmental commitments. Any necessary permit modifications are the responsibility of the CONTRACTOR. CONTRACTOR is responsible for all costs associated with these additional areas, including premium right-of-way costs. If additional right-of-way is necessary beyond what has been evaluated in the NEPA documentation, CONTRACTOR shall be responsible for any re-evaluation of the approved Environmental Documents.

3. ROW acquisition costs shall be defined as amounts paid for: (1) direct payments for ownership or other property rights, and (2) direct payments for eligible relocation expenses as provided for under the Uniform Act less Premium ROW acquisition costs.
4. Premium ROW acquisition costs shall be the amount a jury award or a settlement that exceeds "Just compensation." "Just compensation" shall be defined as the value SCDOT approves for a parcel after the following procedure: CONTRACTOR shall submit its recommendation for just compensation based on appraisals and appraisal reviews which support the recommendation. If SCDOT approves CONTRACTOR'S recommendations, that value becomes just compensation. If SCDOT does not approve the recommendation, CONTRACTOR or SCDOT shall obtain another appraisal using an appraiser from the SCDOT's approved list and submit this appraisal to SCDOT. SCDOT shall be responsible for the cost of the second appraisal. SCDOT shall assign a value to the parcel which shall be deemed just compensation supported by the appraisals for the parcel.
5. CONTRACTOR shall be responsible for right-of-way service costs and right-of-way acquisition costs.
6. SCDOT shall be responsible for premium right-of-way costs except for those additional areas explained above.
7. Upon final completion of the project, if any right-of-way condemnation actions are still pending, CONTRACTOR shall be responsible for adequate security to cover its contractual obligation relating to right-of-way acquisition.

IX. PERMITS

- A. All permits necessary for completion of this project shall be procured by the CONTRACTOR. The CONTRACTOR shall comply with all local, state, and federal permitting requirements. Regarding any permit or license that must be obtained in the name of SCDOT, the CONTRACTOR shall perform all functions within its power to obtain the permit or license, and SCDOT shall fully cooperate in this effort and perform any functions that must be performed by SCDOT. The CONTRACTOR shall submit permit applications to SCDOT. SCDOT will submit the permit

application to the appropriate permitting agency indicating that CONTRACTOR is acting as an agent for SCDOT. If said regulatory agencies fail to issue permits in a timely manner, SCDOT may, on an individual basis, consider a time extension for permit approval delays when CONTRACTOR can demonstrate that the application was submitted in a timely manner, all reasonable efforts have been made to expedite the permit approval, and that the delay has a direct impact on the Critical Path. CONTRACTOR shall not be entitled to additional compensation for delays in permit approval.

X. ENVIRONMENTAL COMPLIANCE

A. Compliance with Environmental Commitments

CONTRACTOR shall comply with all Environmental commitments and requirements including, but not limited to, the following:

1. Compliance with the provisions of all environmental permits applicable to the Project. A copy of the environmental document is included in **Attachment B**. Environmental Commitments are included in **Exhibit 4**.
2. Compliance with those stipulations and conditions under which SCDOT received approval of the Environmental Document(s) and any modifications resulting from a re-evaluation of the Document(s). If the CONTRACTOR elects to construct the Project in a manner that is not consistent with the assumptions in the SCDOT prepared environmental documents, the CONTRACTOR will be responsible for revising the environmental documents and provide any additional studies that may be required. All revisions will require SCDOT and FHWA, if applicable, approval prior to any right of way acquisition or construction activity;
3. Compliance with applicable laws and regulations relating to potential or actual hazardous materials that may be encountered in the course of carrying out this Agreement;
4. Carrying out all necessary social, economic, and environmental studies required by regulatory authorities in the course of construction;
5. Cost, preparation, revision, acquisition, compliance, and adherence to conditions of any permits required by federal, state, or local laws or regulations; The CONTRACTOR is responsible for any mitigation required by permits. Compensatory mitigation may be available through an approved mitigation bank or Permittee Responsible Mitigation (PRM) as define in EPA's 2008 Mitigation Rule; and
6. The resolution of any deviations from the contract documents, drawings or other information included in the environmental permits that would violate the intent or spirit of the permits. Any proposed changes within the permitted areas would need to be coordinated with SCDOT's Environmental Services Office.

B. Preconstruction / Partnering Conference(s)

CONTRACTOR shall conduct one (or more, if appropriate) pre-construction / partnering conference(s) prior to any construction activity to discuss environmental and permitting issues, which conference shall include all subcontractors, and, to the extent feasible, representatives from the U.S. Army Corps of Engineers, the S.C. Department of Health and Environmental Control Water Quality Division, the FHWA, CONTRACTOR, and SCDOT.

C. Protection of Archeological and Paleontological Remains and Materials

1. When archeological or paleontological remains are uncovered, CONTRACTOR shall immediately halt operations in the area of the discovery and notify SCDOT.
2. Archeological remains consist of any materials made or altered by man which remains from past historic or prehistoric times (i.e. older than 50 years) Examples include old pottery fragments, metal, wood, arrowheads, stone implements or tools, human burials, historic docks, structures or not recent (i.e. older than 100 years) vessel ruins. Paleontological remains consist of old animal remains, original or fossilized, such as teeth, tusks, bone, or entire skeletons.
3. SCDOT will have the authority to suspend the work for the purpose of preserving, documenting, and recovering the remains and materials of archeological and paleontological importance for the State. CONTRACTOR shall carry out all instructions of SCDOT for the protection of archeological or paleontological remains, including steps to protect the site from vandalism and unauthorized investigations, from accidental damage and from dangers such as heavy rainfall or runoff.
4. CONTRACTOR's Contract Time and or Contract Price shall be adjusted to the extent CONTRACTOR's cost and /or time of performance have been adversely impacted by the presence of archeological or paleontological remains.

D. Community and Public Relations Plan

The CONTRACTOR shall provide to SCDOT for review and written approval a Community Relations Plan as part of the Project in accordance with Exhibit 5. The Community Relations Plan shall describe how the CONTRACTOR will actively promote good relationships with local elected officials, the news media, and the community at large. All costs associated with community relations will be included in the Total Project Cost. SCDOT will expect the CONTRACTOR to maintain positive communications with the local community (including public meetings as necessary), the adjacent property owners, and local businesses. The Community Relations Plan shall be submitted within 45 calendar days after NTP.

XI. HAZARDOUS MATERIALS

- A.** The CONTRACTOR is referred to Attachment A Exhibits and Attachment B for information and requirements regarding Hazardous Materials inspections and other environmental documentation regarding Hazardous Materials. The CONTRACTOR shall be responsible for handling, storage, remediation, and disposal of any materials, wastes, substances and chemicals deemed to be a solid waste or hazardous waste under applicable state or federal law, (hereinafter "Hazardous Materials") encountered at the Site which were identified in the Hazardous Materials inspections or other environmental documentation regarding Hazardous Materials provided in Attachment A Exhibits and Attachment B and the cost of these activities shall be included in the Contract Price.
- B.** If the CONTRACTOR's plan includes demolition, removal, or disposal of existing structures not previously inspected by SCDOT, the Contractor is required to perform lead-based paint and asbestos inspections on the existing structures prior to performing those activities. The cost of the lead-based paint and asbestos inspections shall be included in the Contract Price. Removal of lead-based paint and asbestos and lead-based paint and asbestos containing materials identified by inspections shall be by a qualified independent firm retained by the Department or by negotiating a construction change directive with the CONTRACTOR as outlined in the procedures in Article XI.F.
- C.** If the CONTRACTOR's plan includes demolition, removal, or disposal of existing structures previously surveyed by SCDOT, but the asbestos inspection reports have expired, the CONTRACTOR is required to perform new asbestos inspections on the existing structures prior to performing those activities. The cost of the asbestos inspections shall be included in the Contract Price. The cost of removal, handling, storage, remediation, and disposal of asbestos containing materials identified in the expired inspection reports shall be included in the Contract Price.
- D.** A copy of the lead-based paint and asbestos inspection reports and the notification of demolition or renovation forms must be submitted to SCDHEC at least ten (10) working days prior to demolition of an existing structure. Prior to submitting the reports and forms to SCDHEC, the CONTRACTOR shall obtain the RCE's signature. The CONTRACTOR is responsible for obtaining all required permits to proceed with the work.
- E.** The CONTRACTOR is responsible for all necessary containment, removal, transportation, and disposal of the subsurface and surface Hazardous Materials identified in inspections or other environmental documentation provided in Attachment B in compliance with all applicable Federal (EPA, OSHA & DOT) and State (SCDHEC & SCDOT) and local (County and Municipality) requirements for Hazardous Materials and worker health and safety. The CONTRACTOR is responsible for obtaining all required permits to proceed with the work.

- F. Unexpected Hazardous Materials** – Upon encountering any unexpected Hazardous Materials, the CONTRACTOR shall follow the procedures as described below:
1. CONTRACTOR shall stop Work immediately in the affected area and duly notify SCDOT and, if required by state or federal law, all government or quasi-government entities with jurisdiction over the Project or site.
 2. Upon receiving notice of the presence of Hazardous Materials, SCDOT will take necessary measures required to verify that the Hazardous Materials are remediated or rendered harmless. Such necessary measures will include SCDOT either (i) retaining qualified independent firm or (ii) negotiating a construction change directive with CONTRACTOR.
 3. CONTRACTOR shall resume Work at the affected area of the Project only after written notice from SCDOT that the (i) Hazardous Materials have been removed or rendered harmless and (ii) all necessary approvals have been obtained from all government and quasi-government entities having jurisdiction over the Project.
 4. CONTRACTOR's Contract Price and/or Contract Time shall be adjusted to the extent CONTRACTOR's cost and/or time of performance has been adversely impacted by the presence of Hazardous Materials.
 5. If a construction change directive is negotiated, the CONTRACTOR shall comply with Article XI.E.
- G.** For purposes of this Project, the Hazardous Material Generator shall be listed as "SCDOT" of any and all Hazardous Materials and/or hazardous wastes associated with work on the Project, with the exception that CONTRACTOR shall be the generator for all Hazardous Materials it, its consultants, subconsultants, subcontractors or suppliers, brings on to the Project or that is brought to the Project by them and subsequently is caused to be released on the Project by the CONTRACTOR, CONTRACTOR's design consultants, subcontractors and suppliers. The foregoing shall not preclude or limit any rights or remedies that SCDOT may have against third parties and/or prior owners, lessees, licensees and occupants of the Project's right of way.
- H.** SCDOT is not responsible for Hazardous Materials actually brought to the Project by CONTRACTOR, CONTRACTOR's design consultants, subcontractors and suppliers or anyone for whose acts they may be or are liable. SCDOT is not responsible for negligent or willful acts by CONTRACTOR, CONTRACTOR's design consultants, subcontractors and suppliers or anyone for whose acts they may be or are liable relating to Hazardous Materials found at the site. CONTRACTOR shall indemnify, defend and hold harmless SCDOT and SCDOT's officers, directors, employees and agents from and against all claims, losses, damages, liabilities and expenses, including attorney's fees and expenses arising out of or resulting solely from those Hazardous Materials actually brought to the Project or negligent or willful acts relating to Hazardous Materials, or both by CONTRACTOR, CONTRACTOR's

design consultants, subcontractors and suppliers or anyone for whose acts they may be or are liable.

XII. DEMOLITION, REMOVAL & DISPOSAL OF STRUCTURES

CONTRACTOR shall be responsible for the demolition, removal and disposal of all structures and their appurtenances within SCDOT Right of Way necessary for the completion of the Project, to include those portions which may extend outside the right of way, but were purchased as a part of the acquisition process. Structures shall include the bridges identified in the scope of work and all buildings acquired for the Project. All necessary permitting shall comply with Articles II.B.4 and IX of the Contract. Handling and disposal of Hazardous Materials shall be in accordance with Article XI of the Contract. Before demolition of the structures, the CONTRACTOR shall complete and submit a Notification of Demolition and Renovation form to the South Carolina Department of Health and Environmental Control.

XIII. DIFFERING SITE CONDITIONS

- A. "Differing Site Conditions" are defined as concealed or latent physical conditions at the Site that (i) materially differ from the conditions reasonably assumed to exist based on the information contained in the RFP, this Agreement and its Exhibits; or (ii) are of an unusual nature, differing materially from the conditions ordinarily encountered and generally recognized as inherent in the work. For this project, geotechnical/geological conditions WILL NOT be considered as a Differing Site Condition.
- B. Upon encountering a Differing Site Condition, CONTRACTOR shall provide prompt written notice to SCDOT of such condition, which notice shall not be later than twenty (20) days after such condition has been encountered. CONTRACTOR shall provide such notice before the Differing Site Condition has been substantially disturbed or altered and before any work is performed.
- C. Upon written notification, SCDOT will investigate the conditions and if it is determined that the conditions differ materially and cause an increase or decrease in the cost or time required for performance of the work, the Contract will be adjusted. No contract adjustment that results in a benefit to CONTRACTOR will be allowed unless CONTRACTOR has provided the required written notice.

XIV. FORCE MAJEURE

Delays or failures of performance shall not constitute breach of the Agreement if and to the extent such delays or failures of performance are caused by severe and not reasonably foreseeable occurrences beyond the control of SCDOT or CONTRACTOR, including, but not limited to: Acts of God or the public enemy; expropriation or confiscation of facilities; compliance with any order or request of any governmental authority other than SCDOT or a party in privity with it; a change in law directly and substantially affecting performance of the Project; Acts of War; rebellion or sabotage or damages resulting there

from; fires, floods, explosions, or extraordinary accidents; riots or strikes or other concerted acts of workman, whether direct or indirect, or any similar causes, which are not within the control of SCDOT or CONTRACTOR respectively, and which by the exercise of reasonable diligence, SCDOT or CONTRACTOR are unable to prevent. Any expense attributable to such occurrence shall not entitle CONTRACTOR to an adjustment in the Contract Price. Any critical path delay attributable to such an occurrence shall be added to the Contract Time.

XV. WARRANTY

- A. CONTRACTOR warrants that it will perform all services in accordance with the standards of care and diligence normally practiced by recognized engineering and construction firms in performing services and obligations of a similar nature. CONTRACTOR warrants that all materials and equipment furnished shall be of good quality and new unless otherwise authorized by SCDOT and that the construction shall conform to the Contract requirements. CONTRACTOR agrees to promptly correct, at its own expense, defects or deficiencies in materials and workmanship that appear prior to and during a period of three (3) years after Final Completion of the Project. This shall include all plant-produced materials (i.e. asphalt, concrete, etc.). CONTRACTOR shall not be responsible for damages caused by SCDOT's failure to provide timely notification of potentially damaged or defective work of which SCDOT had actual knowledge. CONTRACTOR shall properly perform, at the written request of SCDOT made at any time within the warranty period after Final Completion of the Project as defined in Article IV.A.5, all steps necessary to satisfy the foregoing warranty and correct any element of the Project or the services that is defective or does not reflect such standards of care and diligence. The cost of such corrective services shall be CONTRACTOR's responsibility.
- B. CONTRACTOR further warrants the performance of all bridge components on all structures for three (3) years from Final Completion of the Project. If a component fails to perform properly for any reason, including but not limited to normal wear and tear, the CONTRACTOR shall replace the failed component at no cost to SCDOT.
- C. The warranty periods begin at Final Completion of the Project. CONTRACTOR shall immediately abate any warranty deficiency that poses an unsafe condition to the public; otherwise deficiencies shall be corrected no later than 30 days from the determination of corrective action. In the event CONTRACTOR, after notice, fails to immediately abate the deficiency or fails to make correction within the prescribed thirty (30) days, SCDOT may have the deficiency corrected. All costs associated with such correction by SCDOT shall be the responsibility of the CONTRACTOR and his Surety. With respect to any component that is repaired or replaced pursuant to this warranty, the warranty period of that component shall be the longer of one year from repair or replacement of the component or the remainder of the original warranty period.

- D. CONTRACTOR shall take all steps necessary to transfer to SCDOT any manufacturer's or other third-party's warranties of any materials or other services used in the construction of the Project.

XVI. INDEMNITY

- A. CONTRACTOR shall indemnify, defend and hold SCDOT harmless from any and all claims, liabilities and causes of action for any fines or penalties imposed on SCDOT by any state or federal agency because of violation by CONTRACTOR or any of its subcontractors of any state or federal law or regulation.
- B. CONTRACTOR shall indemnify, defend and hold SCDOT harmless from any and all claims, liabilities and causes of action arising out of or resulting from, in whole or in part, the negligence or recklessness of CONTRACTOR or its agents, consultants and/or subcontractors.

XVII. TERMINATION AND CANCELLATION

A. Termination for Default

1. CONTRACTOR shall be in default of the Contract if it:
 - a. Fails to supply a sufficient number of properly skilled workmen, tools, materials and equipment to assure the prompt completion of the work;
 - b. Fails to perform work in accordance with contract requirements and/or refuses to remove or replace rejected materials or unacceptable work;
 - c. Discontinues the prosecution of the work;
 - d. Fails to resume work that has been discontinued within a reasonable time after notice to do so;
 - e. Becomes insolvent or is declared bankrupt or commits any act of bankruptcy or insolvency;
 - f. Allows any final judgment to remain unsatisfied for a period of 15 days;
 - g. Makes an assignment for the benefit of creditors;
 - h. Fails to maintain the Project schedule;
 - i. Commits a substantial breach of the Contract; or
 - j. For any other cause whatsoever, fails to carry on the work in an acceptable manner.
2. If CONTRACTOR does not commence work to cure the default within 15 days after receipt of written notice from SCDOT and thereafter diligently prosecute

work to completion within a reasonable time as determined by SCDOT, then SCDOT will have full power and authority to terminate CONTRACTOR for default and shall provide written notification of the termination to CONTRACTOR and Surety.

3. Upon termination for default, Surety will have the right to complete the contract and shall be given thirty (30) days, or longer in SCDOT's discretion, in which to resume the work. This procedure shall not in any way serve to extend the contract time. All charges incident to negotiation with the Surety and arranging for work to be resumed, including attorney's fees, shall be charged against CONTRACTOR or Surety as part of the cost of the work.
4. If Surety refuses to complete the work or fails to take over the work promptly as provided by this Agreement, then SCDOT may appropriate or use any or all materials and equipment on the job site as may be suitable and acceptable and may enter into an agreement for the completion of the Contract. All costs and charges incurred by SCDOT together with the cost of completing the work under the Contract will be deducted from any monies due or which may become due CONTRACTOR. If such expense exceeds the sum which would have been payable under the Contract, CONTRACTOR and Surety shall be liable and shall pay to SCDOT the amount of such excess.
5. Upon termination for default, all Project Documents, as defined in Article II.E, shall be surrendered forthwith by CONTRACTOR to SCDOT. SCDOT will be authorized to use the Project documents for the sole purpose of promoting, completing, using, maintaining, upgrading or adding to the Project. This authorization includes allowing design professionals to make changes, corrections, or additions to the Project documents for these purposes.
6. If, after termination, it is determined that the Contractor was not in default, or that the default was excusable, the rights and obligations of the parties shall be the same as if the termination had been issued for the convenience of the State.

B. Termination for Convenience

1. SCDOT reserves the right to cancel the Work upon ten (10) days written notice to CONTRACTOR. Should the Work be so canceled by SCDOT for convenience, CONTRACTOR shall be paid for the value of the Work, based upon the Schedule of Values, performed to the date of cancellation and demobilization together with any cancellation charges by vendors and subcontractors. CONTRACTOR shall also be entitled to the cost of securing the work, provided such cost is approved by SCDOT. In no event, however, shall the total payment to CONTRACTOR pursuant to such a cancellation exceed the Contract Price.
2. Termination of all or a portion of the Contract shall not relieve CONTRACTOR of any responsibility it would otherwise have for the work completed, or for any claims arising from that work.

3. Upon such termination, all Project Documents, as defined in Article II.E, shall be surrendered forthwith by CONTRACTOR to SCDOT. SCDOT will be authorized to use the Project documents for the sole purpose of promoting, completing, using, maintaining, upgrading or adding to the Project. This authorization includes allowing design professionals to make changes, corrections, or additions to the Project documents for these purposes.

XVIII. DISADVANTAGED BUSINESS ENTERPRISES

- A. DBE Goal - CONTRACTOR shall comply with the DBE Goal and the requirements of the SCDOT DBE – Design Build Special Provision, attached hereto in EXHIBIT 5, and the SCDOT DBE Supplemental Specification.
- B. SCDOT'S Right to Audit - SCDOT will have the right to audit all documentation regarding DBE participation in the Project.

XIX. ON-THE-JOB TRAINING REQUIREMENTS

There is an On-The-Job Training Requirement for this Project. The CONTRACTOR shall comply with the requirements, including the number of persons to be trained, provided in the Specific Equal Employment Opportunity Responsibilities Training Special Provisions within the Federal Aid Supplemental Specifications found in Exhibit 5. The CONTRACTOR shall submit its plan for On-the-Job Training to SCDOT for written approval prior to commencing construction activities.

XX. RECORD RETENTION

- A. CONTRACTOR shall maintain the following documents for a period of three (3) years or a period equal to the warranty period, whichever is longer, after Final Completion of the Project:
 1. All CONTRACTOR samples and test reports;
 2. Daily Diaries and any other documents required to be retained in accordance with the Quality Control Plan.
- B. During the retention period, SCDOT will be granted access to those documents upon reasonable notice. At any time during the retention period, SCDOT will have the option of taking custody of the documents. CONTRACTOR shall obtain a written release from SCDOT prior to destroying the records after the retention period.

XXI. AS-BUILTS

- A. In addition to those documents set forth elsewhere in this Agreement, CONTRACTOR shall provide to SCDOT prior to Final Completion, complete sets of as-built drawings (See Article XXI.D for details). As-built plans consist of the final version of the design plan CADD drawings that incorporate all changes, including any adjustments, relocations, additions and deletions that occurred during

- construction. CONTRACTOR shall certify that the as-built plans are a true and correct representation of the work as constructed. If any design changes occur during construction, the plan sheets (or any other “job site record document” with a seal) revised after award of contract shall include a complete accounting and detail of the revisions and design changes. The P.E. responsible for the revisions shall seal each altered plan sheet (or any other “job site record document” with a seal). This documented information is to be part of the As-Built Plan requirements. The CONTRACTOR shall develop as-built plans in accordance with the SCDOT Manual of Instructions for the Preparation of As-Built Plans, edition effective as of the release of the Final RFP.
- B. Information regarding major revisions to the plans shall be noted in a revision box on the plans. The information listed in the revision box shall include: the initiator of the revision, a brief explanation of the nature of the revision, and acceptance and approval from CONTRACTOR, along with associated dates.
- C. In addition to the revisions that incorporated changes during construction, the as-built plans shall include the following information gathered during construction:
1. The location and elevation of foundations remaining below grade.
 2. The final profile of each bridge constructed. The profile shall include the elevation along the centerline (or as specified by SCDOT) and a line three feet inboard of each gutter line. Points on the profile shall be taken at no greater than 25-foot intervals and shall include the beginning and end of each span.
 3. If any structure has pile foundations, information concerning the pile driving operation shall be listed to include pile and driving equipment data, final pile bearing, elevation of pile tip when plan bearing was obtained, final pile tip elevation, penetration into the ground, and PDA or WEAP analysis data. This information shall be entered on each footing or bent sheet, or be included as a new sheet inserted immediately following the pertinent footing or bent sheet.
 4. If any structure has drilled shaft foundations, information concerning the installation of the shaft shall be listed to include the drilled shaft report. This information shall be entered on each footing or bent sheet, or be included as a new sheet inserted immediately following the pertinent footing or bent sheet.
 5. The final horizontal location of all existing and relocated utility lines and structures that are within the right-of-way. Include approved Utility Agreements, No Cost/No Conflict Letters, and Encroachment Permits.
 6. The final location and elevations of all pipes, culverts, and drainage structures.
 7. To include all right-of-way revisions, permissions, and an updated right-of-way data sheet to show the date and manner of acquisition of each tract

- D. As-built plans shall be submitted as two (2) full size (36 inch x 22 inch) copies and one (1) copy on compact disc in a format acceptable to SCDOT. The levels and symbology of the as-built CADD drawings shall conform to SCDOT standard levels and symbology used to develop the design drawings for the Project.

XXII. ESCROW PROPOSAL DOCUMENTS

The Contractor shall submit bid documentation used to prepare the technical and cost proposals for this contract to the Department in accordance with the Supplemental Specification entitled Escrow Bid Documentation dated October 1, 2014.

XXIII. DISPUTE RESOLUTION

- A. Each party hereby waives a trial by jury regarding any dispute between them arising out of this Contract and any such trial will be a non-jury trial before the South Carolina Circuit Court in Richland County.
- B. In the event of a dispute between the parties, it shall be a condition precedent to litigation that the parties submit the dispute to the Standing Dispute Review Board pursuant to the Claims Procedure set forth in the Project Supplemental Specifications.
- C. CONTRACTOR consents that any papers, notices, or process necessary or proper for the initiation or continuation of any disputes, claims, or controversies relating to the Agreement; for any court action in connection therewith; or for the entry of judgment on any award made, may be served on CONTRACTOR by certified mail (return receipt requested) addressed to CONTRACTOR at the address provided in Article XXVI. Notice by certified mail is deemed duly given upon deposit in the United States mail.

XXIV. SCDOT'S AGENT

SCDOT will appoint an individual who will be authorized to act on behalf of SCDOT, with whom CONTRACTOR may consult at all reasonable times, and whose instructions and decisions will be binding upon SCDOT as to all matters pertaining to this Agreement and the performance of the parties hereunder.

XXV. ASSIGNABILITY

The Contract shall not be assignable by CONTRACTOR without the prior written consent of SCDOT. SCDOT may assign the Contract without the consent of CONTRACTOR.

XXVI. GENERAL PROVISIONS

- A. This Agreement shall be governed by and interpreted in accordance with the substantive laws of the State of South Carolina.
- B. Headings and titles of the various parts of this Agreement are for convenience of reference only and shall not be considered in interpreting the text of this Agreement. Modifications or amendments to this Agreement must be in writing and executed by duly authorized representatives of each party.
- C. In the event that any portion or all of this Agreement is held to be void or unenforceable, the parties agree to negotiate in good faith to reach an equitable agreement which shall affect the intent of the parties as set forth in this Agreement.
- D. All notices pertaining to this Agreement shall be in writing and, if to SCDOT, will be sufficient when sent registered or certified mail to SCDOT addressed as follows:

Deputy Secretary for Engineering
South Carolina Department of Transportation
Post Office Box 191
Columbia, South Carolina 29202-0191

All notices to CONTRACTOR shall be sufficient when sent registered or certified mail to CONTRACTOR addressed as follows:

(Insert CONTRACTOR'S address here)

- E. The Contract Documents set forth the full and complete understanding of the parties as of the Effective Date defined herein, and supersedes any and all agreements and representations made or dated prior thereto.
- F. The parties make no representations, covenants, warranties or guarantees, express or implied, other than those expressly set forth herein. The parties' rights, liabilities, responsibilities and remedies within respect to the work shall be exclusively those expressly set forth in this Agreement.
- G. In no event shall any failure by either party hereto to fully enforce any provision to this Agreement be construed as a waiver by such party of its right to subsequently enforce, assert or rely upon such provision.
- H. Nothing in this Agreement is intended to create any contract rights for any party other than SCDOT and CONTRACTOR, nor are any third-party beneficiary rights intended to be created hereby.

US 21 over Harbor River Bridge Replacement
Beaufort County

IN WITNESS WHEREOF, the parties hereto have executed this Agreement as of the Effective Date defined herein. The Effective Date is defined as the date signed by the Director of Construction on behalf of South Carolina Department of Transportation.

Witnesses:

SOUTH CAROLINA DEPARTMENT
OF TRANSPORTATION

By: _____
Todd Steagall, P.E.
Director of Construction

Date: _____

Recommended:

Brian Parnell
Contract Administration Engineer

Witnesses:

CONTRACTOR

Name of Contractor

By: _____

Its: _____

CERTIFICATION OF CONTRACTOR

I hereby certify that I am the duly authorized representative of CONTRACTOR and that neither I nor the above CONTRACTOR I here represent has:

- a) employed or retained for a commission, percentage, brokerage, contingent fee, or other consideration, any firm or person (other than a bona fide employee working solely for me or the above CONTRACTOR) to solicit or secure this contract;
- b) agreed, as an express or implied condition for obtaining this contract, to employ or retain the services of any firm or person in connection with carrying out the contract, or
- c) paid, or agreed to pay, to any firm, organization or person (other than a bona fide employee working solely for me or the above CONTRACTOR) any fee, contribution, donation, or consideration of any kind for, or in connection with, procuring or carrying out the contract except as here expressly stated (if any);
- d) either directly or indirectly, entered into any agreement, participated in any collusion, or otherwise taken any action, in restraint of free competitive bidding in connection with the submitted proposal.

By execution of this Agreement, CONTRACTOR certifies CONTRACTOR and all CONTRACTOR's consultants, sub-consultants, contractors, employees and agents will comply with South Carolina's Ethics, Government Accountability, and Campaign Reform Act of 1991, as amended. The following statutes require special attention: (a) Offering, giving, soliciting, or receiving anything of value to influence action of public employee - §8-13-790, 8-13-705, 8-13-720; (b) Recovery of kickbacks - §8-13-790, (c) Offering, soliciting or recovering money for advice or assistance of public official - §8-13-720, (d) Use or disclosure of confidential information - §8-13-725, (e) Persons hired to assist in the preparation of specifications or evaluation of bids - §8-13-1150, (f) Solicitation of state employees - §8-13-755, 8-13-760 and §8-13-725, (g) False Claims Act -§16-13-240. The state may rescind any contract and recover all amounts expended as a result of any action taken in violation of this provision.

I acknowledge that this certificate is to be furnished to the Department, the Federal Highway Administration, and the U. S. Department of Transportation, and is subject to applicable State and Federal laws, both criminal and civil.

I acknowledge that giving false, misleading, or incomplete information on this certification may subject me to prosecution under Section 16-9-10 of the South Carolina Code of Laws.

CONTRACTOR

Name of Contractor

By: _____

Date: _____

Its: _____

CERTIFICATION OF DEPARTMENT

I hereby certify that I am the Director of Construction for the South Carolina Department of Transportation (SCDOT) of the State of South Carolina and that the above CONTRACTOR or its representative has not been required, directly or indirectly, as an express or implied condition in connection with obtaining or carrying out this agreement to:

- a) employ or retain, or agree to employ or retain, any firm or person, or
- b) pay, or agree to pay, to any firm, person, or organization, any fee, contributions, donations, or consideration of any kind, except as here expressly stated (if any).

I acknowledge that this certificate is to be furnished to the Federal Highway Administration, and U. S. Department of Transportation, and is subject to applicable State and Federal laws, both criminal and civil.

SOUTH CAROLINA DEPARTMENT OF
TRANSPORTATION

BY: _____

TITLE: DIRECTOR OF CONSTRUCTION

Date: _____

DRUG-FREE WORKPLACE CERTIFICATION

In accordance with Section 44-107-30, South Carolina Code of Laws (1976), as amended, and as a condition precedent to the execution of this agreement, the undersigned, who is an authorized representative of the CONTRACTOR certifies on behalf of the CONTRACTOR that the PROPOSER will provide a drug-free workplace by:

- (1) publishing a statement notifying employees that the unlawful manufacture, distribution, dispensations, possession, or use of a controlled substance is prohibited in the CONTRACTOR's workplace and specifying the actions that will be taken against employees for violations of the prohibition;
- (2) establishing a drug-free awareness program to inform employees about:
 - (a) the dangers of drug abuse in a workplace;
 - (b) the person's policy of maintaining a drug-free workplace;
 - (c) any available drug counseling, rehabilitation, and employee assistance programs; and
 - (d) the penalties that may be imposed upon employees for drug violations;
- (3) making it a requirement that each employee to be engaged in the performance of the agreement be given a copy of the statement required by item (1);
- (4) notifying the employee in the statement required by item (1) that, as a condition of employment of this agreement, the employee will:
 - (a) abide by the terms of the statement; and
 - (b) notify the employer of any criminal drug statute conviction for a violation occurring in the workplace no later than five days after the conviction;
- (5) notifying the South Carolina Department of Transportation within ten days after receiving notice under item (4)(b) from an employee or otherwise receiving actual notice of the conviction;
- (6) imposing a sanction on, or requiring the satisfactory participation in a drug abuse assistance or rehabilitation program by, any employee convicted as required in Section 44-107-50; and
- (7) making a good faith effort to continue to maintain a drug-free workplace through implementation of items (1), (2), (3), (4), (5), and (6)

By execution of this Agreement CONTRACTOR certifies CONTRACTOR and all CONTRACTOR's consultants, sub-consultants, contractors, employees and agents will comply with all applicable provisions of the Drug-Free Workplace Act, Title 44, Chapter 107 of the South Carolina Code of Laws, as amended.

CONTRACTOR: _____
(Signature)

EXHIBIT 1

COST PROPOSAL BID FORM

PROPOSED COST PROPOSAL BID FORM
FOR
US 21 OVER HARBOR RIVER BRIDGE REPLACEMENT
BEAUFORT COUNTY

The Cost Proposal Bid Form, as submitted by the selected PROPOSER, will be included with the completed agreement.

EXHIBIT 2

SCHEDULE OF VALUES

SCHEDULE OF VALUES
FOR
US 21 OVER HARBOR RIVER BRIDGE REPLACEMENT
BEAUFORT COUNTY

A Schedule of Values, submitted by the selected PROPOSER and approved by SCDOT, will be included with the completed agreement.

EXHIBIT 3

SCOPE OF WORK

EXHIBIT 3 – SCOPE OF WORK

The project consists of all work necessary to complete the design and construction of a fixed span high-level replacement bridge over the Harbor River and associated roadway approaches along US 21 in Beaufort County. The existing swing span and approach spans are currently load restricted due to structural conditions. The project includes demolition and removal of the existing bridge, all appurtenances, and portions of the approach roadways as well as demolition and removal of all abandoned utility facilities that remain in place after relocations are complete.

The Contractor shall maintain highway traffic throughout the project and shall maintain the navigational requirements of the USCG throughout the project. Refer to Exhibit 5 for existing bridge operation and maintenance requirements during construction as well as requirements for salvaging portions of the existing swing-span bridge.

For a full understanding of the scope of the project and the criteria of the construction items needed for this project, review Exhibit 4, Exhibit 5, Exhibit 6 and Attachment B.

EXHIBIT 4

PROJECT DESIGN CRITERIA

EXHIBIT 4 – PROJECT DESIGN CRITERIA

This exhibit details the criteria by which the project shall be designed and constructed. These criteria are divided into subsections as listed below:

Exhibit 4a – Roadway Design Criteria

Exhibit 4b – Structures Design Criteria

Exhibit 4c – Pavement Design Criteria

Exhibit 4d – Traffic Design Criteria

Part 1 – Signing and Pavement Markings

Part 2 – Work Zone Traffic Control

Exhibit 4e – Hydraulic Design Criteria

Exhibit 4f – Geotechnical Design Criteria

Exhibit 4g – Environmental Design Criteria

Exhibit 4z – Project Deliverables

DESIGN REFERENCES

This exhibit describes the general design considerations and criteria for the proposed roadway approaches, hydraulics, structures, and surveys.

Design standards shall be in accordance with the following design references as supplemented or amended by Sections 4a, 4b, 4c, 4d, 4e, 4f, and 4g of this Exhibit. Any variation in design from the included information shall require written approval from SCDOT.

The Contractor shall prepare the design for the Project using the Design Standards and criteria that are appropriate with proper consideration given to the design traffic volumes, adjacent land use, design consistency, aesthetics, ADA requirements, and this document.

The design elements shall include, but not be limited to, the horizontal and vertical alignments, lane widths, shoulder widths, median widths, cross slopes, borders, sight distance, side slopes, front slopes and ditches. The design developed by the Contractor shall be an engineering solution that is not merely an adherence to the minimum AASHTO and/or Department standards.

- AASHTO A Policy on Design Standards Interstate System, 2005
- AASHTO Drainage Manual, 2014 first edition
- AASHTO Guide for the Development of Bicycle Facilities, 1999
- AASHTO Guide for the Planning, Design, and Operation of Pedestrian Facilities, 2004
- AASHTO Highway Drainage Guidelines, 2007
- AASHTO LRFD Bridge Design Specifications, 2012, Sixth Edition (with 2013 Interim Revisions)
- AASHTO Roadside Design Guide, with 2006 Chapter 6 update, 3rd Edition
- AASHTO Standard Specifications for Highway Bridges, 17th Edition
- AASHTO Standard Specifications for Structural Supports for Highway Signs, Luminaires and Traffic Signals, Sixth Edition
- AASHTO/AWS D1.5M/D1.5:2010 Bridge Welding Code, with 2011 interims
- AASHTO “Standard Specifications for Transportation Materials and Methods of Sampling and Testing” 2013 Thirty-Third Edition
- AASHTO Guide Specifications and Commentary for Vessel Collision Design of Highway Bridges, 2nd Edition (with 2010 Interim Revisions)
- FEMA Regulations, 44CFR Chapter 1
- FHWA Manual on Uniform Traffic Control Devices, 2009
- FHWA Publication No. FHWA NHI-07-071 Earth Retaining Structures, 2008
- NCHRP Report 672, Roundabouts: An Informational Guide – Second Edition
- SCDHEC NPDES Construction Permit # SCR160000
- SCDHEC NPDES MS4 Permit # SCS040001
- SCDOT Access and Roadside Management Standards, August 2008 with updates
- SCDOT Americans with Disabilities Act Transition Plan, January 2009
- SCDOT Bridge Design Manual, 2006

EXHIBIT 4 – PROJECT DESIGN CRITERIA

- SCDOT Bridge Design Memoranda, effective between July 1, 2006 and the Final RFP release date
- SCDOT Bridge Drawings and Details, effective as of the Final RFP release date
- SCDOT Engineering Directives, effective as of the Final RFP release date
- SCDOT Geotechnical Design Manual, 2010 Edition (Version 1.1)
- SCDOT Geotechnical Drawings and Details, effective as of the Final RFP release date
- SCDOT Highway Design Manual, 2003, with updates effective as of the Final RFP release date and supplemented with AASHTO A Policy on Geometric Design of Highways and Streets, 2001
- SCDOT Instructional Bulletins, effective as of the Final RFP release date
- SCDOT Pavement Design Guidelines, July 2008 Edition
- SCDOT Guidelines for Asphalt Mixture Selection
- SCDOT Plan Preparation Guide, 2000
- SCDOT Preconstruction Advisory Memorandums, effective as of the Final RFP release date
- SCDOT Preconstruction Design Memorandum, effective as of the Final RFP release date
- SCDOT Preconstruction Survey Manual, effective as of the Final RFP release date
- SCDOT Procedures and Guidelines for Work Zone Traffic Control Design, effective as of the Final RFP release date
- SCDOT Qualified Product Lists, effective as of the Final RFP release date
- SCDOT Requirements for Hydraulic Design Studies, May 2009
- SCDOT Road Design Reference Material for Consultant Prepared Plans, June 2010
- SCDOT Roadside Plants to Avoid/Trees with Limitations on R/W, October 2014
- SCDOT Seismic Design Specifications for Highway Bridges, 2008 (Version 2.0)
- SCDOT Standard Drawings, effective as of the Final RFP release date
- SCDOT Standard Specifications for Highway Construction, 2007
- SCDOT Stormwater Quality Design Manual, effective as of the Final RFP release date;
- SCDOT Supplement to the MUTCD
- SCDOT Supplemental Specifications (2007), effective as of the Final RFP release date
- SCDOT Supplemental Technical Specifications, effective as of the Final RFP release date
- SCDOT Traffic Signal Design Guidelines, 2009 with updates
- SCDOT Traffic Signal Material Specifications, effective as of the Final RFP release date
- SCDOT Traffic Signal Supplemental Specifications, effective as of the Final RFP release date
- SCDOT Street Trees and Sidewalk Planting Suggestions, May 2013
- SCDOT Vegetation Management Guidelines, effective as of the Final RFP release date
- SCDOT Water Quality Design Memorandums, effective as of the Final RFP release date
- South Carolina State Water Law
- The Rule on Work Zone Safety and Mobility, Policy and Guidelines
- The State Stormwater and Sediment and Erosion Control Regulations administered by DHEC, 26 S.C. Code Ann. Regs. 72-405 (Supp. 1995) et seq.
- TRB Highway Capacity Manual, 2010
- United States Access Board's Revised Draft Guidelines for Accessible Public Rights-of-Way (PROWAG), November 23, 2005
- International Building Code, effective as of the Final RFP release date

EXHIBIT 4 – PROJECT DESIGN CRITERIA

- ACI 318 Building Code and Commentary
- ASCE’s “Minimum Design Loads for Buildings and Other Structures”, latest edition

EXHIBIT 4a

ROADWAY DESIGN CRITERIA

1.0 GENERAL

Prepare the roadway geometric design for the project using the design standards and criteria that are appropriate based on design speed, functional classification, design traffic volumes, right-of-way, and aesthetics. The design elements shall include, but not be limited to, the horizontal and vertical alignments, lane widths, shoulder widths, median widths, sight distance, clear zone, cross slopes, and side slopes.

2.0 CRITERIA

Classify the terrain as level on all routes within the scope of work. Use the WB-62 design vehicle for all geometric design.

2.1 Functional Classification

The functional classification for the roadway is as follows:

- US 21 Rural Minor Arterial

2.2 Design Speed

- US 21 55 mph

2.3 Cross Sectional Elements

Develop traffic lane, shoulder, and median widths in compliance with SCDOT Highway Design Manual.

US 21

- Through Lanes 12 ft.
- Shoulder (outside) 10 ft. total (6 ft. paved, 4 ft. earth)

2.4 Vertical Curves, Grades, and Clearances

Develop vertical curves, grades, and clearances in compliance with SCDOT Highway Design Manual.

Use grade adjusted K values where the downgrades are 3 percent or greater.

Do not use spline grades.

Truck-climbing lanes are not required.

2.5 Cross Slopes

Develop cross slopes in compliance with SCDOT Highway Design Manual.

Mainline:

- Shoulder (paved) 4 ft. or less Match travel way pavement slope
- Shoulder (paved) greater than 4 ft. 24:1

2.6 **Clear Zones**

Use the SCDOT HDM (2003 with updates) Chapter 14 and the *Roadside Design Guide* (AASHTO) edition 2006 with Chapter 6 Update, 3rd Edition based on traffic volumes, design speed, and slopes. Do not limit the clear zones provided in Figure 14.3A in the SCDOT HDM (2003 with updates) to 30 feet as indicated as a possibility in the footnote for this figure. When a range of values is shown, select higher value. SCDOT does not typically use a 3H:1V fill slope. See the *Roadside Design Guide* (AASHTO) edition 2006 with Chapter 6 Update, 3rd Edition for clear zone calculations where a 3H:1V fill slope is used. Use 3H:1V fill slopes only where fill heights are required to match existing conditions and clear zone can be obtained within the Project limits.

For those areas where no guardrail currently exists, design fill and cut slopes to obtain clear zones and to avoid the need for protection. Where achieving the clear zone requirements results in new right-of-way, wetland impacts, or impacts to immovable obstructions, protect substandard areas contingent upon receiving SCDOT approval.

Any Other Roads

Use the SCDOT HDM (2003 with updates) Chapter 14 and the *Roadside Design Guide* (AASHTO) edition 2006 with Chapter 6 Update, 3rd Edition based on traffic volumes, design speed, and slopes.

Provide clear zone for any facilities using curbs on this project in compliance with SCDOT HDM (2003 with updates) Chapter 14.

2.7 **Roadside Barriers**

Develop roadside barriers in compliance with SCDOT Highway Design Manual. Include the following items in the work:

Guardrail: Replace all existing guardrail and end treatments within the project limits. New guardrail shall be added where necessary in order to meet current design standards. The CONTRACTOR shall place asphalt curb and flume in front of all new guardrail posts according to SCDOT Standard Drawing 803-105-00 and 403-205-01. Asphalt flume shall be placed at locations to ensure adequate drainage or as directed by the SCDOT Resident Construction Engineer. CONTRACTOR shall pave the entire shoulder width in front of all new guardrail utilizing the mainline pavement design shown in Exhibit 4c.

Ensure that all new guardrail and end treatments are listed on the Qualified Products Policies & Listings.

Provide paving under guardrail in accordance with the guidance found in the Exhibit 5, Special Provisions Section 403.

Where right of way or environmental impacts dictate that standard guardrail shoulder break cannot be built, use additional length guardrail posts with compressed guardrail shoulder break contingent upon receiving SCDOT approval.

2.8 Right-Of-Way

Refer to SCDOT Highway Design Manual Chapter 30.

If right-of-way is required, secure right-of-way in accordance with Uniform Relocation Assistance and Real Property Acquisition Policies Act of 1970 (Public Law 91-646), as amended and revise environmental document, if needed.

Provide a minimum right-of-way width of 100 feet each side of the structure centerline, to a point 75 feet from each end of the bridge. Adjust the length of the 100 foot right-of-way as required at the bridge ends to preclude cutting off access to the underside of the bridge by the toe of fill.

Provide sufficient right-of-way to cover all permanent facilities.

EXHIBIT 4b

STRUCTURES DESIGN CRITERIA

1.0 GENERAL

Exhibit 4b contains the structural design requirements for the project.

2.0 CRITERIA

2.1 Bridges

2.1.1 Bridge Design

Design bridges in accordance with the requirements of the AASHTO LRFD Bridge Design Specifications. Use the HL-93 design live loading.

2.1.2 Seismic Design

In accordance with the SCDOT Seismic Design Specifications for Highway Bridges, the Bridge Operational Classification (OC) is “I.” Design and detail bridges such that all plastic hinges will form above ground and above Mean Higher High Tide Elevation 2.97 NAVD 88, where the hinge region can be easily inspected and repaired if necessary.

2.1.3 Bridge Roadway Widths

Construct bridges with bridge roadway widths that are equal to or greater than the approach roadway widths (traveled way plus total shoulder widths) that are specified in Exhibit 4a.

2.1.4 Vertical Clearances

Provide a main channel span navigational vertical clearance of no less than 65 feet above Mean Higher High Tide Elevation 2.97 NAVD 88 across the entire limits of horizontal clearance specified herein. To accommodate marine traffic, maintain this 65 feet of required vertical clearance over the existing navigational opening during construction of the new bridge.

In addition to the main channel span navigational vertical clearance requirement, provide a minimum vertical clearance of 45 feet **above Mean Higher High Tide Elevation 2.97 NAVD 88** over the navigation zone. The navigation zone is defined as that portion of the waterway where the existing ground line is at or below Elevation -10.0 NAVD 88.

2.1.5 Horizontal Clearances

Provide a main channel span navigational horizontal clearance of a minimum of 90 feet, measured from channel face of fender system to channel face of fender system. In addition, provide a minimum distance of 120 feet, measured from channel face of substructure element to channel face of substructure element, between bridge piers that support the

span over the navigational channel. Locate the main channel span as specified in Section 2.1.6. To accommodate marine traffic, ensure that at least one of the two existing 60-foot wide navigational openings remains unobstructed at all times.

2.1.6 Navigational Channel

Locate the new main channel span over at least one of the two existing 60-foot wide navigational openings. Provide a location survey and coordinate with the USCG to verify the location of the navigational channel for the main channel span.

2.1.7 Vessel Collision Analysis

2.1.7.1 General Requirements

Perform a vessel collision analysis on the replacement structure in accordance with the requirements of Article 3.14 of the AASHTO LRFD Bridge Design Specifications and with the requirements of the AASHTO Vessel Collision Design of Highway Bridges. For the purpose of Article 3.14, the bridge is assigned an operational classification of “critical or essential.” Use the Method I acceptance criteria. For the vessel collision analysis, consider the navigation zone as the area with existing ground line at or below Elevation -10.0 NAVD 88.

Although a fender system is required to be constructed at the navigational channel, do not consider the fender system when determining the vessel collision design loads for the bridge substructures. In addition, do not use dynamic analysis techniques that take into account force-deformation, or other dynamic interaction, between the collision vessel and bridge structure during collision.

Based on the vertical clearance that is required, superstructure vessel collision forces do not need to be considered. Also, design for intentional vessel collision is not required.

2.1.7.2 Collision Events

Consider, as a minimum, the following two collision events:

- Event 1 – Drifting empty Barge impacting vulnerable bridge elements. Combine the vessel impact loads with one-half of the predicted long-term scour plus one-half of the predicted short-term scour. Assume this event corresponds with the 100-yr flood event.

- Event 2 – Ship & Barge tow impacting vulnerable bridge elements while in transit. Combine the vessel impact loads with one-half of the predicted long-term scour, with no short-term scour. Assume this event corresponds with both a low tide event and a high tide event.

The long-term and short-term scours are defined in Article C.1.2.1.1 of the AASHTO Vessel Collision Design of Highway Bridges Guide Specification.

2.1.7.3 Design Vessels

For the design Barge, use a single Small Deck Barge (45 feet x 120 feet). Assume an empty displacement of 250 tons and a Draft of 2 feet (Event1). Assume the Barge, when loaded, has a maximum displacement tonnage of 400 tons and a Draft of 3.5 feet (Event 2). Assume the Barge has a head-log height of 2 feet, a depth of 8 feet, and a bow rake length of 14 feet.

For Event 2, assume the Ship is a Towboat (24 feet x 70 feet) with a gross displacement tonnage of 100 tons and a Draft of 7.5 feet. Assume the speed of the combined Ship and Barge tow under power is a maximum of 10 knots, including tide induced water velocity. Use this vessel impact speed at all substructure locations within the navigation zone as specified in Section 2.1.7.1. Do not apply the provisions of Article 3.7 of the AASHTO Guide Specifications for Vessel Collision Design of Highway Bridges to lower the vessel impact speed.

2.1.8 Fender System

Provide a bridge fender system at the main span navigational channel. Design and detail the fender system as an independently supported system; do not connect the fenders to the bridge bents or foundations. Construct the fender system using prestressed concrete piles, treated timber wales, and stainless steel hardware. Design the fender system for dead load, wind load, and wave action impact. Sample fender system details are provided in Attachment C.

2.1.9 Navigational Lighting

Provide navigation lighting at the main channel span as per AASHTO and United States Coast Guard (USCG) requirements. One 3/4-inch minimum diameter conduit shall be detailed in each concrete parapet for navigational lighting. Conduit is not allowed to be embedded in bridge deck. Lighting conduit and junction boxes shall not be shared with other utilities. See Exhibit 5 for navigational lighting specifications.

2.1.10 Removal and Disposal of Existing Structures

Remove and dispose of the existing structures and appurtenances, including components of previous fender systems, in accordance with Exhibit 4g, Exhibit 5, the Standard Specifications for Highway Construction, and all applicable laws and regulations.

2.1.11 Superstructure Types

For this project, Section 12.3.3 of the SCDOT Bridge Design Manual does not apply. Allowable superstructure types are outlined in Sections 12.3.2.1, 12.3.2.2, 12.3.2.3, and 12.3.2.4 of the SCDOT Bridge Design Manual.

For prestressed concrete girder superstructures, use prestressed concrete girders that are “I” shaped. Design prestressed concrete girders so that the algebraic sum of the beam camber at prestress transfer due to prestress force, the beam dead load deflections due to non-composite dead load, and superimposed dead load deflections due to applied superimposed dead loads results in a positive (upward) camber. Include the dead load from the future wearing surface in the determination of camber.

For steel welded plate girder superstructures, use structural steel girders that are “I” shaped. For steel welded plate girder and steel rolled beam superstructures, use structural steel that conforms to the requirements of AASHTO M 270 and paint the steel in accordance with Section 710 of the Standard Specifications. Apply the intermediate and final coats of paint after the deck is cast and the overhang forms are removed.

At each support of prestressed concrete girder, steel welded plate girder, and steel rolled beam superstructures, connect all beams and girders to the substructure using anchor bolts.

Detail all construction stages for girder bridges to consist of a minimum of two lines of girders.

Floorless culverts are classified as "Other Structure Types" (Section 12.3.3 of the SCDOT Bridge Design Manual) and are not permitted for this project.

2.1.12 Concrete

Use ASTM C150 Type II cement for cast-in-place substructure elements.

2.1.13 Concrete Strengths

In prestressed concrete piles and beams, concrete design strengths are not allowed to exceed 8,000 and 10,000 psi maximum, respectively.

Construct all superstructure cast-in-place concrete bridge components with Class 4000 concrete except as noted in Section 2.1.15. Construct all substructure cast-in-place concrete bridge components with concrete having a design strength of at least 4,000 psi, but no greater than 5,000 psi. Construct all precast concrete bridge components with concrete having a minimum compressive strength of 5,000 psi.

2.1.14 Final Finish of Exposed Concrete Surfaces

Final surface finish is not required on this project.

2.1.15 Lightweight Concrete

Lightweight Concrete is only permitted in cast-in-place deck slabs and barrier parapets. Use lightweight concrete that conforms to the requirements of the Sand Lightweight Concrete Special Provision in Exhibit 5. When calculating dead loads, include a minimum allowance of 7 pounds per cubic foot for reinforcing steel.

2.1.16 Concrete Cover

Provide concrete cover as required by the Bridge Design Manual and Bridge Design Memorandums with the following modifications:

Element or Condition	Minimum Concrete Cover
Substructure Concrete within the Splash Zone, Water Column and/or Scour Zone	4 ½”
Concrete Cast Against and Permanently Exposed to Earth	4 ½”
Substructure Concrete Exposed to Earth or Weather	4”
Prestressed Concrete Piles	3”
Drilled Shafts in Soil (applies to hoops)	6”

The splash zone is the vertical distance from 4 feet below Mean Low Tide Water elevation to 12 feet above Mean High Tide elevation. The scour zone is the vertical distance between the natural ground elevation and the lower of the 100-year or 500-year scour elevation.

2.1.17 Post-Tensioning

Post-tensioning is not permitted for this project.

2.1.18 Bridge Decks

For girder and beam spans, construct bridge decks with reinforced cast-in-place concrete. Extend the deck slab a minimum of 1.5 inches and a maximum of 12 inches past the back face of the parapet.

Apply a transverse Grooved Surface Finish to bridge decks in accordance with Subsection 702.4.16 of the Standard Specifications for Highway Construction.

Make the connection of the reinforcing of decks between stages by lap-splice or mechanical splice.

Asphalt overlays are not permitted on bridge decks.

2.1.19 Stay-in-Place Bridge Deck Forms

The Contractor may use permanent stay-in-place bridge deck forms for concrete deck slabs between new beams and girders. Fabricate permanent stay-in-place bridge deck forms and supports from steel conforming to ASTM A 446/A 653, Grades 40 or 50, and having a coating class of G165 in accordance with ASTM A 525. Do not use fillers in the flutes of the stay-in-place forms. Fill form flutes with concrete as the deck slab is placed. Do not use permanent stay-in-place steel bridge deck forms in bays in which longitudinal deck construction joints are located and in bays between stages.

2.1.20 Barriers

Use a single-slope or F-shaped concrete barrier parapet that has a height of 42 inches. At ends where thrie beam guardrail is required, transition the height, after fall protection is no longer required, down to 32 inches using a 10:1 maximum rate. At the guardrail connection face, provide a 4-foot section of barrier that is vertical and that has a 2 inch by 12 inch chamfer at the end (similar to the end wall shown on the barrier transition details of the Bridge Drawings and Details). Detail the barrier parapet parallel to the edge of the adjacent travel lane.

2.1.21 Bridge Drainage

Design and construct bridge deck drainage and bridge end drainage to ensure that the minimum requirements of the SCDOT Bridge Design Manual are met. Design bridge end drainage at the downslope end(s) of the bridge to collect all of the flow not intercepted by the bridge deck inlets.

For closed drainage systems, connect scuppers to under deck collector pipes using a straight section of pipe between the inlet and the collector

pipe. Ensure this straight section of pipe has a minimum diameter of six inches (or equivalent cross sectional area). Design the scuppers in a manner that allows integration into the bridge deck design and does not interfere with structural continuity. Design inlet grates for safe passage of bicycle traffic.

See Exhibit 4e for design requirements at superelevation rollover points.

2.1.22 Pile Sizes and Types

Minimum pile sizes and acceptable pile types are listed below. No other pile types are permitted.

PILE TYPE	MINIMUM SIZE
*Steel H-Piles	HP12x53
*Steel Pipe Piles	12" Diam. (min. wall thickness equal to 1/2")
Solid Prestressed Concrete Piles	**20" Square
Prestressed Concrete Pile Points	**HP10x57

*At End Bents only.

**For the Fender System only, the minimum size for Solid Prestressed Concrete Piles is 18" Square and the minimum size for Prestressed Concrete Pile Points is W8x58.

2.1.23 Steel Piles

Steel piles are only permitted to be used at the end bents. Design steel piles for a 75 year service life based on the results of the Corrosion Series Testing required by the SCDOT Geotechnical Design Manual. At a minimum, apply a corrosion rate of 0.001 inch per year to each surface of steel piles that is exposed to soil.

2.1.24 Steel Pipe Pile Connection Details

The pile connection detail described in Item 2 of Section 19.2.6.3 of the SCDOT Bridge Design Manual does not apply for this project. Terminate steel pipe piles at the bottom of the end bent cap. Connect the piles to the cap using a reinforced concrete infill, with the reinforcing extending into the cap.

2.1.25 Drilled Shafts

SCDOT Bridge Design Memorandum DM0111 contains a requirement to detail the portion of shaft below the construction casing with a diameter that is six inches smaller than the diameter of the casing. This six-inch reduction requirement does not apply to this project. For this project, detail the portion of the shaft below the bottom of the construction casing,

whether in soil or rock, with a diameter that is at least two inches smaller than the diameter of the casing.

When the design for the upper portion of a drilled shaft requires a column reinforcement cage to be inserted into a larger diameter drilled shaft reinforcement cage, provide a construction joint in the shaft just below the bottom of the column cage. Prior to casting the upper portion of the shaft, remove all drilling fluids and unsound concrete and roughen the surface of the construction joint. Arrange for CSL testing to be performed prior to placement of the column reinforcement cage. Install the column reinforcement cage in the upper portion of the shaft prior to concrete placement in that portion of the shaft.

Drilled shafts that have a diameter of 6 feet or greater and a length of 5 feet or greater are considered to be mass concrete elements. See Exhibit 5 for specifications regarding concrete mix design, concrete placement, temperature control, and testing of these large diameter drilled shafts.

2.1.26 Crosshole Sonic Logging (CSL) and Thermal Integrity Profiling (TIP) Testing

Install Crosshole Sonic Logging (CSL) access tubes in all drilled shafts in accordance with the SCDOT Standard Specifications for Highway Construction, 2007 Edition. SCDOT will conduct CSL testing on all of the shafts.

Also, install a central CSL access tube in each drilled shaft that has a diameter of 6 feet or greater and a length of 5 feet or greater. In addition to CSL testing, SCDOT will conduct Thermal Integrity Profiling (TIP) testing on all of these large diameter drilled shafts.

2.1.27 Substructures

Construct interior bents using either cast-in-place reinforced concrete bent caps and columns supported by cast-in-place reinforced concrete drilled shafts or cast-in-place reinforced concrete bent caps supported by a single row of vertical prestressed concrete piles (with or without prestressed concrete pile points). See Exhibit 4g for environmental commitments made regarding the diameter, number, and location of drilled shafts and piles.

Where prestressed concrete piles are used, ensure concrete portions of piles with points extend a minimum of 10 feet below the final ground line or below the 100-year and 500-year scour elevations, whichever is deeper. Do not use pile supported bents to support a span having a length that exceeds 70 feet.

If a drilled shaft is extended above ground, above the scour lines, or through liquefiable soil, structurally design the shaft as a column and detail the longitudinal reinforcing steel with a maximum spacing of 8 inches center-to-center.

For both parallel longitudinal reinforcing bars and parallel transverse reinforcing bars inside drilled shafts, including column reinforcement embedded into drilled shafts, the clear distance between bars shall not be less than five times the maximum aggregate size or 5 inches whichever is larger. When bundled bars are used, consideration shall be given to increasing these minimum clear spacing requirements.

Construct end abutments as spill through abutments (2:1 maximum slope). In addition to the requirements of Section 20.2.8 of the SCDOT Bridge Design Manual, set the elevation of the berm so that the top of the berm (embankment fill) is no greater than 4 feet below the superstructure.

The following applies to bent cap cantilevers for pile supported bents:

- For a cap supported by prestressed concrete piles, provide a minimum of the equivalent of 2 pile widths of distance from the centerline of the exterior pile to the end of the cap.
- Do not detail the intersection of the centerlines of bent and exterior beam/girder on the bent cap cantilever.
- Provide a distance from the centerline of exterior pile to the edge of a slab superstructure, measured along the bent cap centerline, that is less than or equal to 30 percent of the average pile spacing of the bent.

2.1.28 Integral Bent Caps

If integral bent caps are used on this Project, construct the caps using cast-in-place concrete.

2.1.29 Diaphragms for Prestressed Concrete Beam Spans

SCDOT Bridge Design Memorandum DM0311 contains a provision that allows structural steel intermediate diaphragms to be used in some prestressed concrete beam spans. The structural steel diaphragm option does not apply to this project. For prestressed concrete beam spans in this project, construct all intermediate diaphragms with cast-in-place concrete.

2.1.30 Wing Walls

For parallel wing walls (i.e., wing walls that are parallel to the centerline of bridge), detail the bottom of the wing wall level and at the same elevation as the bottom of the bent cap. Detail the top of these wing walls sloped and at the same elevation as the top of the outside edge of the approach slab.

2.1.31 Slope Protection

Protect the bridge end fills with rip rap in accordance with Standard Drawing 804-105-00.

2.1.32 Bridge Joints

Design and detail the bridge deck joints to accommodate the safe passage of bicycles.

Modular expansion joints are not permitted for this project. If finger plate joints are used, provide a neoprene collector trough beneath the joint. Securely attach the collector trough to the superstructure on both sides of the joint. Collect water from the trough in a collector pipe to avoid discharge of run-off into areas where direct discharge of run-off is not permitted.

2.1.33 Bearing Plates

For beveled bearing plates, use a minimum thickness of 1 ½ inches at mid-section while maintaining 1 inch minimum at the low side.

2.1.34 Seismic Isolation Bearings

Seismic isolation bearings are not permitted for this project.

2.1.35 Barriers Supported by Moment Slabs

When required, provide barriers supported by moment slabs that are designed in accordance with the AASHTO LRFD Bridge Design Specifications.

2.1.36 Bridge Plans

As required by the SCDOT Bridge Design Manual, include in the bridge plans Reinforcing Steel Schedules and Quantities Tables for each bridge component (end bents, interior bents, spans, etc.). When these components are required to be constructed in stages, break the Reinforcing Steel Schedules and Quantities Tables down by stage. Immediately following the title sheet, provide a quantities sheet that includes a tabulation of estimated quantities and a summary of estimated quantities.

2.2 **Retaining Walls**

Retaining walls are not permitted for this project.

2.3 **Box Culverts and Box Culvert Extensions**

2.3.1 Design Specifications

Design all new culverts in accordance with the requirements of the AASHTO LRFD Bridge Design Specifications. Use the HL-93 live loading.

The Contractor may design extensions of existing culverts in accordance with the Seventeenth Edition of the AASHTO Standard Specifications for Highway Bridges if the existing culvert was designed using the AASHTO Standard Specifications for Highway Bridges. If this option is selected, design for HS 20-44 Loading or an Alternate Military Loading of two axles four feet apart with each axle weighing 24,000 pounds, whichever produces the greater stress.

Hydraulically design culverts that convey water in accordance with the requirements of the SCDOT Requirements for Hydraulic Design Studies.

Perform subsurface investigations for culverts in accordance with the requirements of the SCDOT Geotechnical Design Manual.

Consider seismic effects for new culverts as required by the SCDOT Seismic Design Specifications for Highway Bridges.

2.3.2 Materials

Use Class 4000 concrete for cast-in-place elements of culverts and use Class 5000 concrete for precast elements of culverts.

Use reinforcing bars conforming to the requirements of ASTM A706, Grade 60. Use Welded Wire Fabric that meets the requirements of AASHTO M 55 or AASHTO M 221.

2.3.3 Design and Detailing Requirements

2.3.3.1 General

Culverts will not be allowed as a substitute for bridges specified in this project. Construct culverts with four sides and using reinforced concrete.

Establish the length of the culvert so that, at the end of the culvert, the theoretical fill slope is 1 foot below the top of the top slab. Locate the culvert headwalls outside of the adjusted clear zone (see SCDOT Standard Drawing No. 805-010-00) where practical or shield the exposed portions of the structure appropriately.

Detail weep holes and French drains in accordance with Section 702 of the SCDOT Standard Specifications for Highway Construction. Locate the weep holes 12 inches above the normal water line.

For culverts that convey water, detail rip rap and geotextile fabric at both ends of the culvert in accordance with SCDOT Standard Drawing No. 804-205-00.

From the beginning of construction until the end of the 75-year design life of the culvert, limit the settlement to 8 inches. Limit the maximum allowable differential settlement along the length of a culvert to 1 inch per 50 feet of culvert length. If deep foundations are used to limit the settlement of a culvert, limit the longitudinal differential settlement between the culvert and the adjacent paved embankment to a maximum of 1 inch in 20 years.

Detail additional reinforcing steel at openings in the top slab or side walls to meet or exceed the reinforcement shown on SCDOT Standard Drawing No. 722-105-02.

Detail all box culverts, whether cast-in-place or precast, with cast-in-place wing walls, head walls, aprons, and cut-off walls on both the inlet and outlet ends. Do not use precast wing walls, head walls, aprons, cut-off walls, and footings.

In situations where guardrail is required and installation of the posts conflicts with the top slab of the culvert, detail a 12'-6" long span of nested guardrail to bypass the culvert if site and culvert geometry permit. For details of this nested guardrail, see SCDOT Standard Drawing No. 805-565-00. As shown on this drawing, detail a 10:1 or flatter slope for the shoulder area and maintain a minimum 5'-6" offset between the face of the guardrail and the back of the head wall. When nested guardrail is required, include on the plans a note specifying that the guardrail installation must comply with SCDOT Standard Drawing No. 805-565-00.

If guardrail is required and site and culvert geometry do not permit the nested guardrail installation, provide a moment slab to anchor the guardrail. Design and detail the moment slab to eliminate transfer of moment to the culvert barrel. If the moment slab is attached to the culvert barrel for resistance to sliding forces, design and detail the connection to resist horizontal sliding forces only.

2.3.3.2 Wing Walls

Wing walls are typically flared out approximately 30 degrees in relation to the centerline of the culvert, but the angle may vary based on site conditions. Detail the wing walls so that the top of the wing wall is at least 12 inches above the finished ground line. Design and detail the wing wall height so that, at the junction of the wing wall and culvert barrel, the top of the wing wall is the same elevation as the top of the top slab of the culvert barrel.

Extend the wing wall at least to a point where the soil can wrap around the exposed face of the wing wall, using a slope of 2H:1V or flatter, without encroaching on the projected barrel opening.

Support wing walls by footings or aprons, but assume no support from the culvert barrel(s).

Detail the thickness of wing walls equal to or greater than the exterior wall thickness of the culvert. If the maximum wing wall height is greater than 5 feet and the wing wall has a layer of reinforcing in each face, provide a minimum of 5 inches of clearance between the mats of reinforcing steel.

2.3.3.3 Aprons

For box culverts, detail aprons as continuously cast-in-place concrete placed from end to end of the wing walls. Aprons may cover the entire area between the wing walls and the ends of the culvert barrel(s) or may follow the edges of the wing wall/culvert barrel(s). Detail the thickness of the aprons equal to or greater than the thickness of the bottom slab unless the bottom slab thickness exceeds 12 inches. If the bottom slab thickness exceeds 12 inches, detail the apron thickness as 12 inches unless a thicker apron is required by design.

2.3.3.4 Cut-off Walls

Detail cut-off walls with a minimum thickness of 10 inches. Detail cut-off walls to extend a minimum of 2 feet below the bottom of the bottom slab or apron. Detail cut-off walls to extend to a depth 2 feet below the scour depth or into unweathered rock. If cut-off walls are used as structural elements, design and detail appropriate reinforcement.

2.3.3.5 Head Walls

Detail head walls with a minimum height of 12 inches above the finished ground line and a minimum thickness of 12 inches. Detail head walls to extend the full width of the culvert barrel(s).

Anchor the head walls to the top slabs of culverts with reinforcing steel that has been designed and detailed to resist overturning and sliding. Detail each face of the head wall with a minimum of 0.2 square inches of reinforcing steel per foot in each direction.

2.3.3.6 Concrete Cover

For cast-in-place box culverts, provide concrete cover to reinforcing in accordance with the AASHTO LRFD Bridge Design Specifications. For W/C ratios that are less than or equal to 0.4, use a concrete cover modification factor of 1.0.

For precast box culverts in counties other than Beaufort, Berkeley, Charleston, Colleton, Dorchester, Georgetown, Horry, and Jasper, detail the clear cover as shown in ASTM C1433 and ASTM C1577. For precast box culverts that convey intermittent flow in Beaufort, Berkeley, Charleston, Colleton, Dorchester, Georgetown, Horry, and Jasper counties, detail the clear cover as shown in ASTM C1433 and ASTM C1577. For precast box culverts that convey permanent flow in Beaufort, Berkeley, Charleston, Colleton, Dorchester, Georgetown, Horry, and Jasper counties, detail a minimum of 3 inches of clear cover for reinforcing.

2.3.3.7 Existing Culverts and Extensions

Where a change in fill height is proposed for culverts remaining in place or being extended, evaluate the existing culvert to determine if it is structurally adequate to handle the revised loading conditions or if it will require total replacement.

Construct all box culvert extensions of existing cast-in-place culverts using cast-in-place concrete. Construct extensions of existing precast culverts using either precast sections or cast-in-place concrete. If precast sections are used, design and detail the extensions with a cast-in-place concrete transition between the end of the existing barrel and the first new section of precast barrel.

For extensions of existing culverts, detail adhesive anchors, #6 (#19) or greater in size, at a maximum spacing of 18 inches in the exposed ends of the existing barrel. Match the interior barrel shape of the new culvert to that of the existing culvert (i.e. chamfers, ledges, etc.) except as noted in Section 2.3.4.3.

2.3.4 Cast-in-Place Concrete Box Culverts

2.3.4.1 General

For culverts with skews greater than 25 degrees, design and detail the transverse reinforcing steel perpendicular to the longitudinal reinforcing steel. For lesser skew angles, design and detail the transverse reinforcing steel either perpendicular or parallel to the skew.

At the discontinuous edges of culvert barrel sections, design edge beams for the top and bottom slabs.

2.3.4.2 Slabs

Use a minimum thickness of 10 inches for cast-in-place box culvert top and bottom slabs.

2.3.4.3 Walls

Detail cast-in-place box culvert walls vertical and detail a minimum thickness of 8 inches. If the vertical opening dimension of the culvert is greater than 5 feet, provide a minimum of 5 inches of clearance between mats of reinforcing in the walls.

For extensions of existing multi-barrel culverts having interior wall thicknesses less than the new wall thicknesses, detail a minimum 6:1 transition at the junction of the new and existing interior walls.

2.3.4.4 Construction Joints

Limit the maximum pouring length of cast-in-place culvert barrel sections to 70 feet. Detail keyed transverse construction joints in the barrel(s) as required to meet this limit. Detail the longitudinal reinforcing steel continuous across the joints.

If the volume of cast-in-place concrete exceeds 225 CY in any pour, provide a pouring sequence on the plans. Complete all concrete pours in less than 5 hours. If a pouring rate greater than 45 CY/hr is needed, indicate on the plans the required pouring rate.

Detail a keyed construction joint in the walls, 4 inches above the top of the bottom slab. When the height of the wall, measured from the top of the bottom slab, is 8 feet or greater, also detail a keyed construction joint between the walls and top slab.

For construction joints located between elevations of extreme low tide and extreme high tide, include requirements on the plans for the joint to be sealed. Detail each exterior side of the joint with a ½ inch chamfer on the upper side of the joint. Specify on the plans that the Contractor seal this ½ inch chamfer with a bonding epoxy conforming to ASTM C881, Type IV, Grade 3, and that the Contractor apply the epoxy in accordance with the manufacturer's written instructions.

2.3.5 Precast Concrete Box Culverts

2.3.5.1 General

Do not use precast box culvert sections if any of the following conditions exist:

- the design earth cover exceeds 20 feet,

- the design earth cover is less than 2 feet,
- the culvert is an extension of an existing cast-in-place culvert, or
- the culvert will be used for pedestrian traffic.

Use monolithically cast box culvert sections. Do not use precast concrete split box culvert sections.

2.3.5.2 Design Requirements

Design precast box culvert sections for new culverts in accordance with ASTM C1577 except when clear cover for reinforcing is required to be 3 inches. Design precast box culvert sections for culvert extensions of existing precast culverts in accordance with either ASTM C1577 or ASTM C1433 except when clear cover for reinforcing is required to be 3 inches. For precast culverts having design fill heights greater than 5 feet, round the design fill height to the next higher 5 foot increment when using the tabulated design information from ASTM C1577 or ASTM C1433.

2.3.5.3 Detailing Requirements

Detail precast box culverts in accordance with SCDOT Standard Drawing No. 722-305-00 and Section 722 of the SCDOT Standard Specifications for Highway Construction. Require on the plans that the Contractor place all precast box culverts on a prepared bed of aggregate (Coarse Aggregate No. 5, No. 56, or No. 57) having a minimum thickness of 6 inches. Extend the aggregate bed the entire width and length of the culvert plus 3 inches beyond the outer walls of the barrel(s).

On the plans for precast box culverts, include details for cast-in-place wing walls, head walls, aprons, cut-off walls, and footings. Detail these cast-in-place elements in accordance with the requirements of Section 2.3.3. Attach these elements to the precast culvert barrel(s) using #6 (#19) adhesive anchors detailed at a maximum spacing of 18 inches in the exposed ends of the barrel(s). Design these elements as self-supporting. Use the adhesive anchors only to control differential settlement.

Where multiple precast box culvert barrels are placed side by side, the plans shall require a 3½ inch minimum and 6 inch maximum space between adjacent barrel sections. The plans shall require this space to be filled with flowable fill or cast-in-place concrete. If the space is filled with flowable fill, the plans shall require that, at both the upstream and downstream ends, the last 6 inches of space between the barrels (measured along the longitudinal direction of

the barrels) be filled with a cast-in-place concrete cap for the full height of the barrels.

2.3.6 Plans Preparation

Include culvert plans within the set of roadway plans and number the sheets using an “S” prefix. Include the following information in the culvert plans:

2.3.6.1 Title Blocks.

In the title blocks of the culvert sheets, include the fill height used to design the culvert, the culvert opening size (span x rise), the station at centerline of culvert, and the slope of fills.

2.3.6.2 Location Sketch.

Provide a location sketch that includes the following information and details:

- proposed culvert outline,
- existing culvert outline as a light, dashed line,
- centerline of roadway,
- direction of stationing,
- station of intersection of roadway centerline and culvert centerline,
- dimensions of culvert barrels,
- length of each end of culvert measured from the roadway centerline,
- skew angle,
- construction staging (if required),
- temporary shoring locations (if required for construction),
- permissible types of temporary shoring (if restricted),
- stream name,
- direction of flow,
- limits of riprap or note that riprap in accordance with SCDOT Standard Drawing No. 804-205-00 (if required),
- north arrow,
- existing structures, features, utilities in vicinity of culvert if they impact culvert construction,
- invert elevations at each end of new culvert or both ends of each side being extended,
- boring locations, and
- hydraulic data.

2.3.6.3 Design Information.

Indicate the design specification and live load in the plans.

2.3.6.4 Plan View.

Provide a plan view that details the culvert, apron, cut-off wall, wing wall, and footing dimensions; the reinforcing bars, bar callouts, and bar spacing; and the location of any required transverse construction joints.

2.3.6.5 Cross Section

Provide section views of the barrel(s), wing walls, head walls, aprons, cut-off walls, and footings detailing the dimensions; the reinforcing bars, bar callouts, and bar spacing; the weep holes and french drains; and the location of construction joints.

2.3.6.6 Reinforcing Steel Schedule and Quantities

For each culvert, include a reinforcing steel schedule that lists the reinforcing steel required for the culvert. In this schedule, include the mark, number of bars required, and dimensions for each reinforcing bar. Immediately below the reinforcing steel schedule, include a list of estimated quantities for the culvert. Include all quantities required for construction of the culvert (e.g., reinforcing steel, concrete, piling, excavation, riprap, geotextile, etc.). For projects requiring stage construction, break the reinforcing steel schedule and quantities down by stage.

2.3.6.7 Boring Logs

Include copies of the boring logs in the plans.

EXHIBIT 4c

PAVEMENT DESIGN CRITERIA

1.0 GENERAL

Exhibit 4c contains requirements for:

- Hot Mix Asphalt (HMA) pavement and base for the new location of US 21.
- Hot Mix Asphalt (HMA) pavement and base for the tie-in of existing US 21 pavement.

2.0 CRITERIA

2.1 New Location

2.1.1 Construct a new HMA pavement with the one of the following characteristics:

Option 1:

200 psy Surface Type B

300 psy Intermediate Type A

450 psy Base Type A

6 inches Graded Aggregate Base Course (GABC)

Shoulder pavement shall match mainline design.

Option 2:

200 psy Surface Type B

200 psy Intermediate Type B

850 psy Base Type A

Shoulder pavement shall match mainline design.

2.2 Existing Pavement

2.2.1 Mill the existing pavement 2.0 inches uniform. Perform full depth patching as directed by RCE. Construct pavement with appropriate cross-slope as defined in other criteria using a combination of buildup and milling such that there is no reduction of existing pavement thickness. Use Surface Type E for build-up up to 1.5 inches. Use Intermediate Type B for build-up that requires greater than 1.5 inches per lift.

The final lift shall be uniform:
200 psy Surface Type B

2.3 General Notes for HMA Pavements

Prior to placing the final permanent pavement markings, all areas not requiring pavement reconstruction or rehabilitation but requiring revised temporary or permanent pavement markings shall be milled 2-inches and resurfaced utilizing 200 psy hot mix asphalt HMA Surface Type B.

Include 150 SY of 6 inch full depth asphalt patching in accordance with the Special Provision in Exhibit 5. Full depth patching shall be conducted prior to variable build up or overlay.

~~Milled in R~~umble strips shall be used on all outside shoulders in accordance with Exhibit 4d SCDOT Standard Drawings and specifications for the entire project.

Surface Type B may be substituted for Intermediate Type B in any of these applications.

Milling shall not exceed 4 inches if traffic is to be placed on the milled surface.

Follow Asphalt Mix Design Guidelines found on SCDOT website for type and rate.

EXHIBIT 4d

TRAFFIC DESIGN CRITERIA

Part 1 – Signing and Pavement Marking

1.0 GENERAL

1.1 Permanent Pavement Markings

Pavement marking work on this project consists of preparing detailed pavement marking plans and applying appropriate markings for the entire length of the project. All edge lines, lane lines, channelization markings, stopbars and word messages and symbols on US 21 and all intersecting routes shall be of the width and patterns detailed in the Standard Drawings. ~~The white edge lines may be 6 inches in width if sufficient shoulder width is present to allow for bicycle traffic.~~ The final roadway surface material will determine which type of permanent marking material is to be applied. The CONTRACTOR shall use preformed tape (T-1) markings on concrete surfaces for the applications noted below. Thermoplastic markings shall be used on all asphalt surfaces. The CONTRACTOR shall install surface mounted raised pavement markers in accordance with the Standard Drawings. Shoulder rumble strips shall be installed in accordance with Engineering Directive 53 on asphalt surfaces. Note as described in ED 53 a minimum 3 feet 6 inches paved shoulder will remain undisturbed for bicycle accommodations.

1.2 Permanent Signing

Signing work on this project consists of preparing a detailed, comprehensive signing plan; and fabricating, furnishing, and erecting new ground mounted guide, regulatory and warning signs. New signs shall be erected over the entire length of the project, including, at a minimum, stop signs on all intersecting routes. Existing signs, if applicable, shall be maintained during construction.

Development of the signing plans should be coordinated through the District Six Traffic Engineering Office. The District Traffic Engineer shall have final approval of all signing plans.

2.0 CRITERIA

2.1 Permanent Pavement Markings

2.1.1 Thermoplastic Pavement Markings (Asphalt Surfaces)

All thermoplastic markings shall meet the requirement of Section 627 of the Standard Specifications.

2.1.2 Preformed Patterned Tape (T-1) Pavement Markings (Concrete Surfaces)

2.1.2.1 The CONTRACTOR shall apply performed patterned tape markings to concrete surfaces on this project with a raised diamond pattern covered with ceramic elements having a refractive index of 1.9 or greater. These markings shall be

installed with a truck mounted application system or other motorized applicator approved by the manufacturer.

- 2.1.2.2 The CONTRACTOR shall provide to the Department the manufacturer's normal warranty which shall guarantee the tape materials for a period of 72 months from the date of installation from failure to retain the minimum reflectance values provided by the manufacturer and from failure due to loss of material adhesion or complete wear through. If failure occurs, the manufacturer will provide the replacement materials to restore the markings to their original effectiveness.

2.2 Permanent Signing

- 2.2.1 The CONTRACTOR is advised that all signs have a unique barcode sticker attached to the back of each sign and each sign assembly has a unique barcode sticker attached to one post of the assembly. The CONTRACTOR will be required to record the barcode number for each sign and the associated assembly that is removed, replaced or relocated. These numbers and the date that the sign and assembly were removed, replaced or relocated shall be recorded on a form and the form shall be and turned into the Resident Construction Engineer.

EXHIBIT 4d

TRAFFIC DESIGN CRITERIA

Part 2 – Work Zone Traffic Control

1.0 GENERAL

The Contractor shall execute the item of Traffic Control as required by the Standard Specifications, the Standard Drawings For Road Construction, the Special Provisions, all Supplemental Specifications, the SCDOT Procedures and Guidelines for Work Zone Traffic Control Design, the MUTCD, the Plans, and the Engineer. This is an amendment to the Standard Specifications to require the following:

2.0 CRITERIA

2.1 GENERAL REGULATIONS

These special provisions shall have priority to the plans and comply with the requirements of the MUTCD and the standard specifications. Revisions to the traffic control plan through modifications of the special provisions and the plans shall require approval by the Department. Final acceptance of any revisions to the traffic control plan shall be pending upon review by the member of the Design-Build team representing the Director of Traffic Engineering through the Design-Review Process.

In accordance with the document, *Rule on Work Zone Safety and Mobility: Implementation, Maintenance, and Safety Guidelines*, this project has been classified as “SIGNIFICANT” and all components of the Transportation Management Plan prepared by the CONTRACTOR are required and shall be implemented.

Install and utilize changeable message signs in all lane closures installed on high volume high-speed multilane roadways. Use of changeable message signs in lane closures installed on low volume low speed multilane roadways is optional unless otherwise directed by the plans and the Engineer. Install and use a changeable message sign within a lane closure set-up as directed by the *Standard Drawings For Road Construction*. When a lane closure is not present for any time to exceed 24 hours, remove the changeable message sign from the roadway. Place the sign in a predetermined area on the project site, as approved by the Engineer, where the sign is not visible to passing motorists. Utilize preprogrammed messages in accordance with the *Standard Drawings For Road Construction* when using the changeable message sign as part of the traffic control set-up for lane closures. Only those messages pertinent to the requirements of the traffic control situation and the traffic conditions are permitted for display on a changeable message sign at all times. At no time will the messages displayed on a changeable message sign duplicate the legends on the permanent construction signs.

During operation of changeable message signs, place the changeable message sign on the shoulder of the roadway no closer than 6 feet between the sign and the near edge of the adjacent travel lane. When the sign location is within 30’ of the

near edge of a travel lane open to traffic, supplement the sign location with no less than 5 portable plastic drums placed between the sign and the adjacent travel lane for delineation of the sign location. Install and maintain the drums no closer than 3 feet from the near edge of the adjacent travel lane. This requirement for delineation of the sign location shall apply during all times the sign location is within 30' of the near edge of a travel lane open to traffic, including times of operation and non-operation. Oversized cones are prohibited as a substitute for the portable plastic drums during this application.

All signs mounted on portable sign supports shall have a minimum mounting height of 5' from the bottom of the sign to the ground. All signs mounted on ground mounted u-channel posts or square steel tube posts shall have a minimum mounting height of 7' from the bottom of the sign to the grade elevation of the near edge of the adjacent travel lane or sidewalk when a sidewalk is present.

On multilane primary routes, avoid placement of signs on portable signs supports within paved median areas utilized for two-way left turns unless otherwise directed by the RCE.

Temporary "Exit" signs (M1025-00) shall be located within each temporary gore during lane closures on multilane roadways. Mount these signs a minimum of 7' from the pavement surface to the bottom of the sign in accordance with the requirements of the MUTCD.

When mounting signs on ground mounted u-section or square steel tube posts, utilize either a sign support / ground support post combination with an approved breakaway assembly or a single direct driven post for each individual sign support of a sign assembly installation. Do not combine a sign support / ground support post combination and a direct driven post on the same sign assembly installation that contains two or more sign supports. Regarding sign support / ground support post combination installations, ensure that post lengths, stub heights and breakaway assemblies comply with the manufacturer's requirements and specifications. Use approved breakaway assemblies found on the *Approved Products List For Traffic Control Devices in Work Zones*.

When covering signs with opaque materials, the Department prohibits attaching a covering material to the face of the sign with tape or a similar product or any method that will leave a residue on the retroreflective sheeting. Residue from tape or similar products, as well as many methods utilized to remove such residue, damages the effective reflectivity of the sign. Therefore, contact of tape or a similar product with the retroreflective sheeting will require replacement of the sign. Cost for replacement of a sign damaged by improper covering methods will be considered incidental to providing and maintaining the sign; no additional payment will be made.

Overlays are prohibited on all rigid construction signs. The legends and borders on all rigid construction signs shall be either reversed screened or direct applied.

Signs not illustrated on the typical traffic control standard drawings designated for permanent construction signs shall be considered temporary and shall be included in the lump sum price bid item for “Traffic Control” unless otherwise specified.

Install “Grooved Pavement” signs (W8-15-48) supplemented with the “Motorcycle” plaque (W8-15P-30) in advance of milled or surface planed pavement surfaces. On primary routes, install these signs no further than 500 feet in advance of the beginning of the pavement condition. On interstate routes, install these signs no less than 500 feet in advance of the beginning of the pavement condition. Install two sign assemblies at each sign location, one on each side of the roadway, on multilane roadways when the pavement condition is present. Install these signs immediately upon creation of this pavement condition and maintain these signs until this pavement condition is eliminated.

Install “Steel Plate Ahead” signs (W8-24-48) in advance of an area of roadway where temporary steel plates are present. Install these signs no further than 300 feet in advance of locations where steel plates are present. On multilane roadways, comply with the same guidelines as applied to all other advance warning signs and install two sign assemblies at each sign location, one on each side of the roadway, when roadway conditions warrant. Install these signs immediately upon installation of a temporary steel plate and maintain the signs until the temporary steel plates are removed.

Install and maintain any necessary detour signing as specified by the typical traffic control standard drawings designated for detour signing, Part VI of the MUTCD, these Special Provisions, and the Engineer. The lump sum price bid item for “Traffic Control” includes payment for installation and maintenance of the detour signing.

The Contractor shall maintain the travel patterns as directed by the traffic control plans and shall execute construction schedules expeditiously. The Contractor shall provide the Resident Engineer with no less than a two-week prior notification of changes in traffic patterns.

During nighttime flagging operations, flaggers shall wear a safety vest and safety pants that comply with the requirements of ANSI / ISEA 107 standard performance for Class 3 risk exposure, latest revision, and a fluorescent hard hat. The safety vest and the safety pants shall be retroreflectorized and the color of the background material of the safety vest and safety pants shall be fluorescent orange-red or fluorescent yellow-green.

During nighttime flagging operations, the contractor shall illuminate each flagger station with any combination of portable lights, standard electric lights, existing

street lights, etc., that will provide a minimum illumination level of 108 Lx or 10 fc.

During nighttime flagging operations, supplement the array of advance warning signs with a changeable message sign for each approach. These changeable message signs are not required during daytime flagging operations. Install the changeable message signs 500' in advance of the advance warning sign arrays. Messages should be "Flagger Ahead" and "Prepare To Stop".

During surface planing and milling operations, grade elevation differences greater than 1 inch in areas with pavements composed of hot mixed asphalt (HMA) base courses, intermediate courses or surface courses and Portland cement concrete are PROHIBITED unless otherwise directed by the Department. However, during surface planing and milling operations for removal of Open-Graded Friction courses ONLY, a grade elevation difference of 1½ inches between adjacent travel lanes opened to traffic may exist unless otherwise directed by the Department.

During the paving operations, the length of roadway with an acceptable grade elevation difference less than or equal to 2" shall be restricted to 4 miles.

During the milling and surface planing operations, the length of roadway with an acceptable grade elevation difference less than or equal to 1" shall be restricted to 4 miles.

During construction on the ramps, the contractor shall conduct flagging operations. The flagging operations shall either stop traffic or direct the traffic around the work area. Installation and operation of these flagging operations shall be according to these special provisions and the MUTCD.

Supplement and delineate the shoulder edges of travel lanes through work zones with traffic control devices to provide motorists with a clear and positive travel path. Utilize portable plastic drums unless otherwise directed by the Department. Vertical panels may be used where specified by the plans and directed by the RCE. The installation of traffic control devices are required in all areas where those areas immediately adjacent to a travel lane open to traffic have been altered in any manner by work activities, including but not limited to activities such as grading, milling, etc. Install the traffic control devices immediately upon initiating any alterations to the areas immediately adjacent to or within 15 feet of the near edge line of the adjacent travel lane. When sufficient space is available, place the traffic control devices no closer than 3 feet from the near edge of the traffic control device to the near edge line on the adjacent travel lane. When sufficient space is unavailable, place the traffic control device at the maximum distance from the near edge of the adjacent travel lane available.

2.2 LANE CLOSURE RESTRICTIONS

The lane closure restrictions stated below are project specific, for all other restrictions, see supplemental specification, “Restrictions”, dated September 1, 2015.

Primary and Secondary Routes –

On primary and secondary routes, the Department prohibits lane closures during any time of the day that traffic volumes exceed 800 vehicles per hour per direction. The Department reserves the right to suspend a lane closure if any resulting traffic backups are deemed excessive by the Engineer. Maintain all lane closure restrictions as directed by the plans, these special provisions, and the Engineer.

All other routes with lane closure prohibitions for this project are listed on the SCDOT website under Doing Business with SCDOT in the Publications and Manuals section for Traffic Engineering.

These restrictions also apply to all road closures and pacing operations. The Department reserves the right to suspend a lane closure if any resulting traffic backups are deemed excessive by the Engineer. Maintain all lane closure restrictions as directed by the plans, these special provisions, and the Engineer.

Installation and maintenance of a lane closure is PROHIBITED when the Contractor is not actively engaged in work activities specific to the location of the lane closure unless otherwise specified and approved by the Engineer. The length of the lane closure shall not exceed the length of roadway anticipated to be subjected to the proposed work activities within the work shift time frame or the maximum lane closure length specified unless otherwise approved by the Engineer. Also, the maximum lane closure length specified does not warrant installation of the specified lane closure length when the length of the lane closure necessary for conducting the work activity is less. The length and duration of each lane closure, within the specified parameters, shall require approval by the Engineer prior to installation. The length and duration of each lane closure may be reduced by the Engineer if the work zone impacts generated by a lane closure are deemed excessive or unnecessary.

On multilane primary and secondary routes, a reduced regulatory speed limit of 35 MPH shall be in effect during lane closures. Erect temporary regulatory “Speed Limit” signs (R2-1-48-35) and “Speed Reduction 35 MPH” signs (W3-5-48-35) on temporary supports according to the typical traffic control standard drawings. Cover the existing regulatory speed limit signs when reduced speed limits are in place. Immediately remove or cover the “Speed Limit” signs (R2-1-48-35) and the “Speed Reduction 35 MPH” signs (W3-5-48-35) upon the removal of the lane closures.

On interstate routes, a reduced regulatory speed limit of 45 MPH shall be in effect during lane closures. Erect temporary regulatory “Speed Limit” signs (R2-1-48-45) and “Speed Reduction 45 MPH” signs (W3-5-48-45) on temporary supports according to the typical traffic control standard drawings. Cover the existing regulatory speed limit signs when reduced speed limits are in place. Immediately remove or cover the “Speed Limit” signs (R2-1-48-45) and the “Speed Reduction 45 MPH” signs (W3-5-48-45) upon the removal of the lane closures.

On interstate routes, the presence of temporary signs, portable sign supports, traffic control devices, trailer mounted equipment, truck mounted equipment, vehicles and vehicles with trailers relative to the installation or removal of a closure and personnel are prohibited within 30 foot clear zone during the prohibitive hours for lane closures specified by these special provisions.

Truck mounted changeable message signs shall be required during all interstate lane closures. The Contractor shall provide, install, and maintain these signs in accordance with all requirements of the Standard Specifications for Highway Construction (latest edition) and the typical traffic control standard drawings designated for interstate lane closures.

The truck mounted changeable message signs are in addition to the requirements for trailer mounted changeable message signs. Truck mounted changeable message signs and trailer mounted changeable message signs are not interchangeable.

The Contractor shall discontinue and remove a lane closure when the work activities requiring the presence of the lane closure are completed or are discontinued or disrupted for any period of time to exceed 60 minutes unless the presence of unacceptable grade elevation differences greater than 1” in milled areas or greater than 2” in all other areas are present unless otherwise directed by the Engineer.

2.3 SHOULDER CLOSURE RESTRICTIONS:

Primary and Secondary Routes –

On primary and secondary routes, the Department prohibits the Contractor from conducting work within 15’ of the near edge of the adjacent travel lane on an outside shoulder or a median area under a shoulder closure during any time of the day that traffic volumes exceed 800 vehicles per hour per direction. The hourly restrictions for lane closures shall also apply to work activities conducted under a shoulder closure within 15’ of the near edge of an adjacent travel lane or a median area. The Department reserves the right to suspend work conducted under a shoulder closure if any traffic backups develop and are deemed excessive by the

Engineer. Maintain all shoulder closure restrictions as directed by the plans, these special provisions, and the Engineer.

On primary and secondary roadways, the Department prohibits the Contractor from conducting work within 1' or less of the near edge of an adjacent travel lane under a shoulder closure. All work that may require the presence of personnel, tools, equipment, materials, vehicles, etc., within 1' of the near edge of an adjacent travel lane shall be conducted under a lane closure.

2.4 MOBILE OPERATIONS

A mobile operation moves continuously at all times at speeds of 3 mph or greater without any stops. The minimal traffic flow impacts generated by these operations involve brief traffic flow speed reductions and travel path diversions. Conduct work operations that cannot be performed at speeds of 3 mph or greater under standard stationary lane closures.

The distance intervals between the vehicles, as indicated in the *Standard Drawings For Road Construction*, may require adjustments to compensate for sight distance obstructions created by hills and curves and any other conditions that may obstruct the sight distance between the vehicles. However, adjustments to the distance intervals between the vehicles should be maintained within the range of variable distance intervals indicated in the standard drawings unless otherwise directed by the Engineer.

Maintain two-way radio communication between all vehicles in the vehicle train operating in a mobile operation.

Supplement the work vehicles and the shadow vehicles with amber colored flashing dome lights. The vehicles may also be supplemented with advance warning arrow panels and truck mounted attenuators as directed in the *Standard Drawings For Road Construction* and the Standard Specifications.

The Contractor shall install, operate and maintain all advance warning arrow panels, truck mounted attenuators and truck mounted changeable message signs as required by these special provisions, the manufacturer's specifications, the *Standard Drawings For Road Construction*, the Standard Specifications, the plans and the Engineer.

2.5 TYPICAL TRAFFIC CONTROL STANDARD DRAWINGS:

The typical traffic control standard drawings of the "Standard Drawings For Road Construction", although compliant with the MUTCD, shall take precedence over the MUTCD. The typical traffic control standard drawings of the "Standard Drawings For Road Construction" shall apply to all projects let to contract.

Install the permanent construction signs as shown on the typical traffic control standard drawings designated for permanent construction signing.

2.6 ADDENDUMS

(Addendums to the “2007 Standard Specifications for Highway Construction”)

2.6.1 Construction (Sub-section 601.4) –

Sub-section 601.4.2 Construction Vehicles (paragraph 2) -

When working within the rights-of-way of access-controlled roadways such as Interstate highways, the Contractor’s vehicles may only change direction of travel at interchanges. These vehicles are prohibited from crossing the roadway from right side to the median or vice versa. Use a flagger to control the Contractor’s vehicles when these vehicles attempt to enter the roadway from a closed lane or the median area. Ensure the flagger does not stop roadway traffic, cause roadway traffic to change lanes, or affect roadway traffic in any manner. The Contractor’s vehicles may not disrupt the normal flow of roadway traffic or enter the travel lane of the roadway until a sufficient gap is present.

The Contractor shall have flaggers available to control all construction vehicles entering or crossing the travel lanes of secondary and primary routes. The RCE shall determine the necessity of these flaggers for control of these construction vehicles. The RCE shall consider sight distance, vertical and horizontal curves of the roadway, prevailing speeds of roadway traffic, frequency of construction vehicles entering or crossing the roadway and other site conditions that may impact the safety of the workers and motorists when determining the necessity of these flaggers. Ensure these flaggers do not stop roadway traffic, cause roadway traffic to change lanes or affect roadway traffic in any manner. The Contractor’s vehicles may not disrupt the normal flow of roadway traffic or enter the travel lane of the roadway until a sufficient gap is present.

When working within the rights-of-way of access-controlled roadways with posted regulatory speed limits of 55 MPH or greater and average daily traffic volumes {ADT} of 10,000 vehicles per day or greater, i.e. Interstate highways, all construction and work vehicles possessing any one or more of the vehicular characteristics listed below are only permitted to enter and exit a right or left shoulder work area during the presence of active lane closures unless otherwise directed by the RCE. These vehicles are not permitted to enter or exit these work areas without the presence of active lane closures unless otherwise directed by the RCE. Shoulder closures are unacceptable and insufficient methods for control of traffic at

ingress / egress areas for these vehicles. The restrictive vehicular characteristics include the following:

- Over six (6) tires
- Tandem rear axles
- A base curb weight greater than 8000 lbs.
- A gross vehicular weight greater than 12000 lbs. unless performing duties as a shadow vehicle while supporting a truck mounted attenuator
- A trailer in tow except under the following conditions:
 - Trailers transporting traffic control devices (including but not limited to standard and 42” oversized traffic cones, portable plastic drums, signs, portable sign supports, u-channel and square steel tube sign posts) relative to the installation of lane closures, shoulder closures or other traffic control operations approved by the RCE
 - Trailer mounted traffic control devices (including but not limited to advance warning arrow panels, changeable message signs, temporary traffic signals, highway advisory radios, work zone intelligent transportation systems and trailer towed truck mounted attenuators)

2.6.2 **Construction (Sub-section 601.4)** –

Sub-section 601.4.2 Construction Vehicles -

Auxiliary Warning Lights for Vehicles and Equipment -

Supplement all construction and/or construction-related vehicles and equipment that operate in a stationary or mobile work zone within or adjacent to a roadway within the highway rights-of-way with AMBER or YELLOW colored high intensity rotating or strobe type flashing auxiliary warning light devices. Utilize, install, operate and maintain a single or multiple lighting devices as necessary to provide visibility to approaching motorists.

All auxiliary warning light models shall meet *Society of Automotive Engineers* (SAE) Class I standards and SAE Standard J575 relative to *Tests for Motor Vehicle Lighting Devices and Components* and these specifications.

The amber/yellow color of the dome/lens of an auxiliary warning light device shall meet SAE Standard J578 for amber/yellow color specifications.

Auxiliary warning lights with parabolic reflectors that rotate shall rotate around a halogen lamp at a rate to produce approximately 175 flashes per minute. The parabolic reflector shall produce a minimum 80,000 candle power and a minimum 54,000 candela through an SAE Standard J846 approved amber dome.

Equip strobe type flashing auxiliary warning light devices with photosensitive circuit controls to adjust the lighting intensity in response to changes in ambient light conditions such as from day to night. These lights shall have a double-flash capability rated at approximately 80 double flashes per minute and produce a minimum 24 joules of flash energy at the highest power level setting.

Acceptable auxiliary warning light models shall provide sufficient light output to be clearly recognizable at a minimum distance of 1750 feet.

Mount all auxiliary warning light devices intended to function as the auxiliary warning light system or as an element thereof on vehicles and equipment at locations no less than 3 feet above the ground and in conspicuous locations to provide visibility to approaching motorists.

Auxiliary warning light devices and/or models that mount in the locations of the standard vehicle lighting system are unacceptable as the specified auxiliary warning light system due to restrictive simultaneous visibility capabilities from multiple sight angles. However, auxiliary warning light devices that mount in the standard vehicle lighting system locations are acceptable as supplements to the specified lighting devices mounted in locations that do meet the minimum height requirements and provide simultaneous visibility capabilities from multiple sight angles.

Standard vehicle hazard warning lights are only permitted as supplements to the specified auxiliary warning light devices.

2.6.3 Category I Traffic Control Devices (Section 603) –

Sub-section 603.2.2 Oversized Traffic Cones (paragraph 6) -

Reflectorize each oversized traffic cone with 4 retroreflective bands: 2 orange and 2 white retroreflective bands. Alternate the orange and white retroreflective bands, with the top band always being orange. Make each retroreflective band not less than 6 inches wide. Utilize Type III – Microprismatic retroreflective sheeting for retroreflectorization on all projects let to contract after May 1, 2010 unless otherwise specified. Separate each retroreflective band with not more than a 2-inch non-reflectorized area. Do not splice the retroreflective sheeting to create the

6-inch retroreflective bands. Apply the retroreflective sheeting directly to the cone surface. Do not apply the retroreflective sheeting over a pre-existing layer of retroreflective sheeting.

Sub-section 603.2.3 Portable Plastic Drums (paragraph 3) -

Reflectorize each drum with Type III – Microprismatic retroreflective sheeting: 2 orange and 2 white retroreflective bands, 6 inches wide on all projects let to contract after May 1, 2010 unless otherwise specified. Alternate the orange and white retroreflective bands with the top band always being orange. Ensure that any non-reflectorized area between the orange and white retroreflective bands does not exceed 2 inches. Do not splice the retroreflective sheeting to create the 6-inch retroreflective bands. Apply the retroreflective sheeting directly to the drum surface. Do not apply the retroreflective sheeting over a pre-existing layer of retroreflective sheeting.

2.6.4 Category II Traffic Control Devices (Section 604) –

Sub-section 604.2.1 Type I and Type II Barricades (paragraph 3) -

Reflectorize these barricades with Type VIII or IX Prismatic retroreflective sheeting on all projects let to contract after May 1, 2012 unless otherwise specified. Ensure that the retroreflective sheeting has alternate orange and white stripes sloping downward at a 45-degree angle in the direction of passing traffic. The stripes shall be 6 inches wide.

Sub-section 604.2.2 Type III Barricades (paragraph 3) -

Reflectorize these barricades with Type VIII or IX Prismatic retroreflective sheeting on all projects let to contract after May 1, 2012 unless otherwise specified. Ensure that the retroreflective sheeting has alternate orange and white stripes sloping downward at a 45-degree angle. Apply the sloping orange and white stripes in accordance with the requirements of the Plans, SCDOT Standard Drawings and the MUTCD. The stripes shall be 6 inches wide.

2.6.5 Temporary Concrete Barrier (Sub-section 605.2.3.2) –

Sub-section 605.2.3.2 Temporary Concrete Barrier (paragraph 6) -

Previously used temporary concrete barrier walls are subject to inspection and approval by the RCE before use. Ensure that previously used temporary concrete barrier walls are in good condition. Defects to a temporary concrete barrier wall that may disqualify a section of wall for use include gouges, cracks, chipped, or spalled areas. A defect that

exposes reinforcing steel warrants immediate disqualification. A disqualification grade type defect shall consist of measurements in excess of 1 inch, entirely or partially within the boundaries of the end connection areas and the drainage slot areas as illustrated in the “Standard Drawings for Road Construction”, and/or in excess of 4 inches for all areas beyond the end connection areas. To warrant disqualification, these measurements shall exceed the specified dimensions in all three directions, width, height, and depth. A defect that exceeds the specified dimensions in only one or two of the three directions does not warrant disqualification.

Temporary concrete barrier walls with defects less than 6 inches in all three directions, width, height, and depth that do not expose reinforcing steel may be repaired in accordance with the following requirements. Repair is prohibited on temporary concrete barrier walls with defects 6 inches or greater in all three directions, width, height, and depth.

For repair of temporary concrete barrier walls with defects less than 6 inches in all three directions, width, height, and depth that do not expose reinforcing steel, repair the defect with a premanufactured patching material specifically fabricated for patching structural concrete. The strength of the patch must meet or exceed the design strength of the class 3000 concrete of the temporary concrete barrier wall. Perform the repair procedures in accordance with all requirements and instructions from the manufacturer of the patch material. Use a bonding compound between the patch material and the concrete unless specifically stated by the manufacturer that a bonding compound is not required. If the manufacturer states that application of a bonding compound is optional, SCDOT requires application of a bonding compound compatible with the patch material. If cracking occurs within the patched area, remove the patch material completely and repeat the repair process. The contractor shall submit documentation stating all repairs have been conducted in accordance with these requirements prior to installing any temporary concrete barrier walls with repairs. Utilization of temporary concrete barrier walls with repairs shall require approval by the RCE prior to installation.

The Contractor shall submit certification documents for the patch material utilized for repairs to the Engineer prior to placing temporary concrete barrier walls that have been repaired on the project site.

*** *(Effective on all projects let to contract after January 1, 2017)* ***

Sub-section 605.2.3.2 Temporary Concrete Barrier (paragraph 5) -

In regard to projects let to contract after January 1, 2017, ALL *NCHRP Report 350* compliant temporary concrete barrier walls placed on a project

site SHALL comply with the requirements for the recessed approval stamp as directed by the *SCDOT Standard Drawings*. Those *NCHRP Report 350* compliant temporary concrete barrier walls with the original recessed approval stamp that reads "SCDOT 350" will continue to be acceptable on projects let to contract after January 1, 2017. However, those temporary concrete barriers with the "SCDOT 350" identification plate attached to the side of the barrier walls with mechanical anchors previously grandfathered will no longer be acceptable on projects let to contract after January 1, 2017.

2.6.6 Construction Signs (Sub-section 605.4.1.1) –

*** (Effective on all projects let to contract after January 1, 2016) ***

On all projects relative to **interstate highways** let to contract after January 1, 2016, all signs attached to portable sign supports on and/or adjacent to **interstate highways** shall be rigid. Fabricate each of these rigid signs from an approved aluminum laminate composite rigid sign substrate approved by the Department. Utilization of signs fabricated from roll-up fabric substrates attached to portable sign supports installed on and/or adjacent to **interstate highways** will no longer be acceptable on projects let to contract after January 1, 2016.

ONLY those portable sign supports specified and approved for support of rigid signs fabricated from approved aluminum laminated composite rigid sign substrates and included on the *Approved Products List for Traffic Control Devices in Work Zones*, latest edition, are acceptable. To facilitate location of acceptable portable sign supports, the listing of portable sign supports is now separated into two (2) sections; "Portable Sign Supports for Use with Roll-Up Signs ONLY" and "Portable Sign Supports for Use with Roll-Up Sign Substrates and Rigid Sign Substrates".

The trade names of the approved aluminum laminate composite rigid sign substrates are "Acopan", "Alpolic", "Dibond" and "Reynolite". These rigid sign substrates are restricted to thicknesses no greater than 2 millimeters.

Rigid signs fabricated from standard aluminum sign blanks or any other rigid material other than Acopan, Alpolic, Dibond or Reynolite are PROHIBITED for attachment to portable sign supports. However, rigid signs fabricated from standard 0.080 and 0.100 inches thick aluminum sign blanks will continue to be acceptable for mounting on ground mounted sign supports.

Signs fabricated from roll-up fabric substrates approved by the Department will continue to be acceptable for use on and/or adjacent to secondary and primary roadways unless otherwise directed by the Department.

The minimum mounting height of signs mounted on these portable sign supports shall continue to be 5 feet from the ground to the bottom edge of the sign except where a minimum 7 foot mounting height is required in accordance with the standard specifications, the standard drawings, these special provisions and the MUTCD, latest edition.

2.6.7 Truck-Mounted Attenuator (Sub-section 605.4.2.2) –

Sub-section 605.2.2.2.3.3 Color (paragraph 1) -

Use industrial grade enamel paint for cover of the metal aspects of the unit. Provide and attach supplemental striping to the rear face of the unit with a minimum Type III high intensity retroreflective sheeting unless otherwise directed by the Department. Utilize an alternating 4 to 8 inch black and 4 to 8 inch yellow 45-degree striping pattern that forms an inverted “V” at the center of the unit that slopes down and to the sides of the unit in both directions from the center.

2.6.8 Truck-Mounted Attenuator (Sub-section 605.4.2.2) –

Sub-section 605.4.2.2 Truck-Mounted Attenuators (paragraph 6) -

A direct truck mounted truck mounted attenuator is mounted and attached to brackets or similar devices connected to the frame of a truck with a minimum gross vehicular weight (GVW) of 15,000 pounds (actual weight) unless otherwise directed. A trailer towed truck mounted attenuator is towed from behind and attached via a standard pintle hook / hitch to the frame of a truck with a minimum gross vehicular weight (GVW) of 10,000 pounds (actual weight) unless otherwise directed.

Each truck utilized with a truck mounted attenuator shall comply with the manufacturer’s requirements to ensure proper operation of the attenuator. The minimum gross vehicular weight (GVW) (actual weight) for each truck shall comply with these specifications unless otherwise directed within the “Remarks” column of the *Approved Products List For Traffic Control Devices in Work Zones* in regard to specific requirements for the device in question.

If the addition of supplemental weight to the vehicle as ballast is necessary, contain the material within a structure constructed of steel. Construct this steel structure to have a minimum of four sides and a

bottom to contain the ballast material in its entirety. A top is optional. Bolt this structure to the frame of the truck. Utilize a sufficient number of fasteners for attachment of the steel structure to the frame of the truck to ensure the structure will not part from the frame of the truck during an impact upon the attached truck mounted attenuator. Utilize either dry loose sand or steel reinforced concrete for ballast material within the steel structure to achieve the necessary weight. The ballast material shall remain contained within the confines of the steel structure in its entirety and shall not protrude from the steel structure in any manner.

2.6.9 Trailer-Mounted Changeable Message Signs (Sub-section 606.3.2) -

Sub-section 606.3.2.7 Controller (paragraphs 1-4) -

The controller shall be an electronic unit housed in a weatherproof, rust resistant box with a keyed lock and a light for night operation. Provide the unit with a jack that allows direct communications between the on-board controller and a compatible personal computer. The unit shall have a LCD display screen that allows the operator to review messages prior to displaying the message on the sign.

The controller shall have the capability to store 199 factory preprogrammed messages and up to 199 additional messages created by the user in a manner that does not require a battery to recall the messages. Also, the controller shall allow the operator the capability to program the system to display multiple messages in sequence.

Provide the controller with a selector switch to allow the operator to control the brightness or intensity level of the light source of the sign panel. The selector switch shall include "bright," "dim" and "automatic" modes; inclusion of additional modes is permissible. When the selector switch is in the "automatic" mode, a photosensitive circuit shall control the brightness or intensity level of the light source in response to changes in ambient light such as from day to night and other various sources of ambient light.

Equip each sign with remote communications capabilities, such as utilization of cellular telephone or internet browser technology, to allow the operator to revise or modify the message selection from the office or other remote location. Also, provide protection to prohibit unauthorized access to the controller, (i.e. password protection).

Sub-section 606.5 Measurement (paragraph 2) -

Trailer-mounted changeable message signs are included in the lump sum item for Traffic Control in accordance with **Subsections 107.12** and **601.5**

of the “2007 Standard Specifications for Highway Construction”. No separate measurement will be made for trailer-mounted changeable message signs unless the contract includes a specific pay item for trailer-mounted changeable message signs.

The Contractor shall provide, install, operate, and maintain the trailer-mounted changeable message sign per traffic control set-up as directed by the Plans, the “Standard Drawings for Road Construction”, these Special Provisions, the Specifications, and the Engineer.

Sub-section 606.6 Payment (paragraph 2) -

In addition to **Subsections 107.12** and **601.6**, the payment for Traffic Control is full compensation for providing, installing, removing, relocating, operating, and maintaining trailer-mounted advance warning arrow panels and trailer-mounted changeable message signs as specified or directed and includes providing the units’ primary power source; repairing or replacing damaged or malfunctioning units within the specified time; providing traffic control necessary for installing, operating, and maintaining the units; and all other materials, labor, hardware, equipment, tools, supplies, transportation, incidentals, and any miscellaneous items necessary to fulfill the requirements of the pay item in accordance with the Plans, the Specifications, and other items of the Contract.

Sub-section 606.6 Payment (paragraph 3) -

Disregard this paragraph unless the Contract includes a specific pay item for trailer-mounted changeable message signs.

2.6.10 Temporary Pavement Markings (Sub-section 609.4.1) –

Sub-section 609.4.1.1.1 Application Requirements General (in addition to paragraph 3) -

On two-lane two-way roadways, apply and place temporary or permanent pavement markings, as specified hereupon, prior to the end of each day’s work or shift or reopening a closed travel lane to traffic. These pavement markings shall include 4-inch wide solid lines on edge lines and solid center lines and 4-inch wide by 10 feet long broken lines with a 30-foot gap for broken center lines and lane lines unless otherwise specified. The center line pavement markings shall be either double yellow solid lines, yellow broken lines or an appropriate combination of a yellow solid line and yellow broken lines for passing / no passing zones. Placement of a singular yellow solid line for a center line pavement marking is

unacceptable. The edge line pavement markings shall be a white solid line.

On multilane primary and secondary roadways, apply and place temporary or permanent pavement markings, as specified hereupon, to the travel lanes prior to reopening a closed travel lane to traffic. These pavement markings shall include 4-inch wide solid lines, utilized for edge lines and solid center lines, and 4-inch wide by 10 feet long broken lines with a 30-foot gap, utilized for lane lines and turn lanes, unless otherwise specified. The center line pavement markings shall be either double yellow solid lines or an appropriate combination of a yellow solid line and 4-inch wide by 10 feet long yellow broken lines for two-way left turn median areas. The right edge line pavement markings shall be a white solid line and the left edge line shall be a yellow solid line except in areas where the travel lanes separate to create a gore type situation and then the color schemes shall comply with SCDOT application practices for gore areas. The lane lines between travel lanes and turn lanes shall be 4-inch wide by 10 feet long white broken lines with a 30-foot gap.

However, on two-lane two-way and multilane primary and secondary roadways, application of a 4-inch wide solid line utilized for an edge line adjacent to an earth shoulder, white or yellow, may be delayed up to 72 hours after eradication of the original line when the length of eradicated line at a single location is no longer than 250 feet. In the event of multiple locations along the same line, each location must be separated from the adjacent location by no less than 250 feet with a cumulative total distance of eradicated line of no more than 1300 feet within any continuous 1 (one) mile length of roadway measured from a selected location. If the length of eradicated line exceeds 250 feet at any single location, the distance interval between multiple adjacent locations is less than 250 feet or a cumulative total distance of multiple locations of eradicated line exceeds 1300 feet within any continuous 1 (one) mile length of roadway measured from a selected location, replace the eradicated line(s) prior to reopening the adjacent travel lane to traffic.

On interstate roadways, apply and place temporary or permanent pavement markings, as specified hereupon, to the travel lanes prior to reopening a closed travel lane to traffic. These pavement markings shall include 6-inch wide solid lines, utilized for edge lines, and 6-inch wide by 10 feet long white broken lines with a 30-foot gap, utilized for lane lines between travel lanes and auxiliary lanes, unless otherwise specified. The right edge line pavement markings shall be a white solid line and the left edge line shall be a yellow solid line except in areas where the travel lanes separate to create a gore type situation and then the color schemes shall comply with SCDOT application practices for gore areas.

On all roadways, apply and place white stop bars and white triangle yield bars in all locations where previous stop bars and triangle yield bars have been eradicated by the work. Apply and place white stop bars and white triangle yield bars at intersections controlled by stop and yield signs within 72 hours of the eradication of the original pavement marking. Apply and place white stop bars at signalized intersections controlled by traffic control signals and at railroad crossings prior to reopening a closed travel lane to traffic.

Within the limits of existing turn lanes on all roadways, apply and place white arrows in all locations where previous arrows have been eradicated by the work unless otherwise directed by the RCE. Apply and place white arrows within 72 hours of the eradication of the original pavement markings. However, in regard to newly constructed turn lanes, apply and place white arrows the within turn lanes as directed by the RCE.

Within the limits of existing lane-drop sites on all roadways, apply and place white arrows in all locations where previous arrows have been eradicated by the work prior to the end of each day's work or shift or reopening the closed travel lane to traffic. In regard to newly constructed lane-drop sites, apply and place white arrows within the travel lane to be terminated prior to opening the travel lane to traffic and as directed by the RCE.

Sub-section 609.4.1.1.1 Application Requirements General (Revision to paragraph 8) -

On two-lane, two-way roadways, passing zones may be eliminated within the work zone through application of 4-inch double yellow centerline pavement markings if determined feasible and directed to do so by the Plans and/or the RCE. Apply no passing zone markings as specified by the Plans, the Specifications, the *MUTCD* and the RCE.

2.6.11 Flagging Operations (Sub-section 610.4.1) –

Sub-section 610.4.1.1 Flagging Operations (paragraph 1) -

Use a flagging operation to control the flow of traffic when two opposing directions of traffic must share a common travel lane. A flagging operation may be necessary during a lane closure on a two-lane two-way roadway, an intermittent ramp closure or an intermittent encroachment of equipment onto a portion of the roadway. Utilize flagging operations to direct traffic around work activities and maintain continuous traffic flow at reduced speeds when determined to be appropriate by the RCE. As stated above, flagging operations shall direct traffic around the work activities and maintain continuous traffic flow; therefore, stopped traffic shall not be

required to stop for time durations greater than those listed below unless otherwise directed by the RCE. Begin measurement of the time interval immediately upon the moment the Flagger rotates the Stop/Slow paddle to display the “Stop” condition to the approaching motorists.

LENGTH OF CLOSURE	MAXIMUM TIME DURATION FOR STOPPED TRAFFIC
1 MILE or LESS	5 Minutes
1 to 2 MILES	7 ½ Minutes

If the work activities require traffic to be stopped for periods greater than 5 to 7 ½ minutes as stated above, consider alternate work methods, conducting work activities during times of lowest traffic volumes such as during the hours of darkness or complete road closure with detour installation.

2.6.12 Paving and Resurfacing (Sub-section 611.4.1) –

Sub-section 611.4.1.2 Requirements (paragraph 8) -

Whenever travel lanes with acceptable grade elevation differences are open to traffic, provide “Uneven Lanes” signs (W8-11-48) or “Uneven Pavement” signs (W8-11A-48). Reflectorize these signs with a fluorescent orange colored prismatic retroreflective sheeting unless otherwise specified. Install these signs adjacent to roadways with uneven pavement surfaces between travel lanes or between travel lanes and the adjacent paved shoulders. Install these signs at intervals no greater than 2600 feet.

2.7 STAGING

2.7.1 Traffic Control Restrictions (Project Specific)

The presence of acceptable grade elevation differences less or equal to 1” in milled areas or less than or equal to 2” in paved areas adjacent to a travel lane open to traffic are prohibited during weekends from 8:00 am Friday to 9:00 pm Sunday unless otherwise directed by the Engineer. When necessary, the weekend restriction may be extended due to the proximity of a holiday as directed by the Engineer.

The Contractor shall have no more than 72 hours to begin elimination of any grade elevation differences between or adjacent to the travel lanes.

The 72 hour time period shall begin upon creation of the grade elevation difference. This restriction shall apply to all acceptable grade elevation differences less than or equal to 1” in milled areas or less than or equal to 2” in paved areas.

During surface planing and milling operations, the length of roadway with a milled surface open to traffic is restricted to 4 miles. This restriction does not apply to concrete diamond grinding operations.

During surface planing and milling operations, the length of roadway with an acceptable grade elevation difference less than or equal to 1” adjacent to a single travel lane or between multiple travel lanes open to traffic is restricted to a maximum distance of 4 miles.

During asphalt paving operations, the length of roadway with an acceptable grade elevation difference less than or equal to 2” adjacent to a single travel lane or between multiple travel lanes open to traffic is restricted to a maximum distance of 4 miles.

The Contractor may conduct various work activities in the same direction at various locations concurrently if approved by the Department. Various work activities in the same direction requiring simultaneous closures in the same travel lane or shoulder shall be separated by no less than 2 miles from the end of the first closure that a motorist will encounter to the beginning of the taper of the second closure. Also, various work activities in the same direction requiring simultaneous right and left lane closures or shoulder closures shall be separated by no less than 4 miles from the end of the first closure that a motorist will encounter to the beginning of the taper of the second closure.

Consider impacts upon local and state emergency response resources.

EXHIBIT 4e

HYDRAULIC DESIGN CRITERIA

1.0 GENERAL

Perform all hydrologic and hydraulic drainage designs in accordance with the “SCDOT’s Requirements for Hydraulic Design Studies”, May 2009, SCDOT’s Stormwater Quality Design Manual, December 2014, and Project Design Criteria as listed in EXHIBIT 4. Designs, as a minimum, to address:

- Ditch capacity and stability analyses
- Storm sewer systems and bridge deck drainage
- Cross-line pipes
- Bridge hydraulics
- Bridge Scour
- Sediment and Erosion Control
- Best Management Practices
- Stormwater Quality Design

2.0 CRITERIA

The Preliminary Stormwater Management Design Study prepared by HDR dated February 21, 2017, contains hydrologic and hydraulic information and preliminary designs for this project. The report is included under Attachment C for information only.

2.1 Roadway Drainage

- 2.1.1 Evaluate the hydrologic and hydraulic conditions for roadway drainage. Ensure offsite areas that affect the hydraulic systems and outfalls of this project are accounted for.
- 2.1.2 Perform hydraulic analyses, including headwater and tail-water effects, on all cross-lines for the design storm event and the 100-year overtopping event
- 2.1.3 Design new and analyze existing closed-drainage systems with GEOPAK drainage software for the design storm event.
- 2.1.4 Perform open channel designs. Include ditch capacity and stability analyses on sideline and outfall ditches impacted within the limits of the project. Minimize channel velocities to non-erosive rates.
- 2.1.5 At locations where fill height is greater than or equal to ten feet, provide a minimum five foot buffer between the toe of fill and the nearest top of bank of any sideline ditch or swale. See Attachment B for a detail.
- 2.1.6 Design temporary drainage systems for the 5-yr storm event and restrict spread to the shoulder width. Minimize ponding at flood sensitive locations.

- 2.1.7 Abandon pipes by filling with flowable fill. Note abandoned pipe locations on drainage sheets.
- 2.1.8 Place minimum Class B riprap, underlined with geotextile, on all 2:1 fill slopes either to the shoulder point or to 2 feet above the mean high higher tide.

2.2 Bridge Design

- 2.2.1 Model natural, existing, and proposed conditions for the bridge following the Hydraulic Design Requirements for coastal engineering. The design shall incorporate the Criteria of Exhibit 4b.2.1. The Contractor has the options to either utilize and update the model provided by Intra Incorporated in Attachment C, sealed on 05/18/16, or develop an independent 2-D unsteady model. If the model in Attachment C is utilized, the data shall be verified by the designer and any modifications or updates to the model becomes the responsibility of the Engineer of Record enacting the modifications.
- 2.2.2 Submit the preliminary model setup and results to the SCDOT before finalizing the model and performing scour calculations. Summarize the inputs and outputs, to include backwater, freeboard and FEMA requirements.
- 2.2.3 The Contractor shall perform the scour analysis for the 100-yr and 500-yr storms in accordance with the Department’s Requirements, USGS, and the latest FHWA’s HEC-18 and HEC-20 editions. Plot the 100-yr and 500-yr total scour lines on the bridge triple profile.
- 2.2.4 Design a closed drainage system to collect bridge deck runoff. Meet the design requirements of Exhibit 4b.2.1.21. Bridge deck drains shall, at a minimum, allow less than 0.2 cfs bypass flow at the superelevation rollover point (0% cross slope) in the 10-year event.
- 2.2.5 Protect the bridge end fills with riprap in accordance with Standard Drawing 804-105-00. Use minimum Class B riprap.

2.3 Floodplains and Floodways

- 2.3.1 This project falls within FEMA Flood Insurance Rate Maps (FIRMs) 4500250135E and 4500250162E dated November 4, 1992 for Beaufort County SC. The Harbor River and portions of Ward Creek are designated within designated Zone V12, an area of 100-yr coastal flood with velocity (wave action).

- 2.3.2 The Contractor shall coordinate with the local County Floodplain Administrator to request for floodplain management compliance.

2.4 Sediment and Erosion Control and Water Quality

- 2.4.1 Develop a plan to meet the requirements of SCDOT’s Construction Permit SCR160000 for erosion and sedimentation control during construction for the entire project length.
- 2.4.2 SCHDEC monitors Harbor River at shellfish monitoring station 16B-06 and has an ambient water quality monitoring site at RO-11310. Monitoring on Ward Creek is at station RT-09099 and at station RO-01163 on St. Helena Sound. Based on the 2014 303(d) list, Station RO-01163 is impaired for turbidity and has a target TMDL date of 2017.
- 2.4.3 The SCDHEC water classification for the Harbor River between St. Helena Sound and Fripp Inlet is an Outstanding Resource Water (ORW) and between St. Helena Sound and Ward Creek is Shellfish Harvesting Waters (SFH).
- 2.4.4 Discharges to 303(d) listed, TMDL, and other sensitive waters such as ORW and SFH require additional water quality treatment methods. Shellfish beds are located within close proximity to the site. Untreated stormwater shall not be discharged within 1,000 feet of a shellfish bed. Per Exhibit 4g, submit a drainage plan to SCDHEC and OCRM prior to finalizing construction plans.

2.5 NPDES Permitting

- 2.5.1 Prepare the NPDES permit package. The Contractor shall perform all agency coordination to obtain the permit. The SCDOT reviews, signs and submits the package to SCDHEC.
- 2.5.2 If Contractor intends to phase the NPDES permitting process, the Contractor shall coordinate a meeting with the District contact, the Environmental Coordinator, and the Hydraulic Lead to explain the intent of the phasing and describe the proposed schedule for the submittals.

EXHIBIT 4f

GEOTECHNICAL DESIGN CRITERIA

1.0 GENERAL

The following items, at a minimum, shall be included in the geotechnical design for this project:

- Design foundations for the proposed bridge structures. All subsurface exploration, geotechnical design, and construction for the Project shall be carried out in accordance with the design criteria below.
- Provide drilled shaft load testing and pile dynamic load testing as outlined in the design criteria and in accordance with the project specifications. The results shall be used to determine capacities of the associated foundation system.
- Design and provide ground improvements as necessary to meet required design criteria and performance limits.

2.0 CRITERIA

The Geotechnical Base Line Report (GBLR) prepared by F&ME dated February 24, 2017, and the Site-Specific Seismic Response Analysis (SSRA) dated March 10, 2017, have been provided in Attachment C for geotechnical information. In addition, soil test boring log input files have been provided electronically in gINT format and CPT raw data files have also been provided.

All geotechnical testing shall comply with the requirements of the SCDOT Geotechnical Design Manual (GDM), 2010, Version 1.1. Geotechnical design shall comply with the requirements stated below and the Special Provisions listed in Exhibit 5. Geotechnical information provided in the Appendix of the GBLR (field and lab data only) as part of this RFP may be used in the design of this project at the Contractor's discretion. If the Contractor elects to use the geotechnical information in the Appendix of the GBLR, the Contractor shall verify that the information provided is applicable to the Contractor's specific design. The Contractor shall verify that geotechnical information provided in Attachment C meets the requirements for a geotechnical investigation for this specific project as required by the GDM. If the requirements of the GDM are not met, then the Contractor shall provide additional geotechnical investigation to meet the geotechnical requirements for this specific project.

2.1 Bridge

Design all bridge structures proposed for this project in accordance with the GDM. Downdrag imposed on drilled shaft construction casing shall be accounted for in the design of all drilled shafts.

The Contractor shall be responsible for the load testing of all foundations used on this project. All testing reports whether for driven piles or drilled shafts shall bear the legible seal, signature, and date of the testing firm's engineer registered as a Professional Engineer in the State of South Carolina. The Contractor's designer shall review and approve, in writing, all load test reports prior to submitting the reports to SCDOT for review and acceptance or comment. Comments made by

SCDOT shall be reviewed and rectified by the Contractor’s designer prior to the results of the load testing being used in design.

2.1.1 Pile Dynamic Load Testing with Pile Driving Analyzer

Pile dynamic load testing with Pile Driving Analyzer (PDA) testing shall be required for driven piles on the Project. The Contractor shall select a testing firm for PDA Testing from those firms currently approved to provide foundation testing services on SCDOT’s Foundation Testing On-Call Contract. In addition to the PDA testing, CAPWAP (Case Pile Wave Analysis Program) analysis shall also be performed. The Contractor shall provide a Pile Installation Plan (PIP) that shall include the pile index testing program. The pile index testing program shall at a minimum include the Bent and Pile number of each pile to be tested as well as the number of index piles to be tested. The number of index piles shall conform to the requirements of the GDM.

2.1.2 Shaft Load Testing

Shaft load testing is required for this project. A non-production drilled shaft shall be tested prior to the construction of any production drilled shafts. Drilled shaft load testing shall consist of a bi-directional static load test, a rapid axial load test, or a high strain dynamic load test.

The number of load tests shall conform to the requirements of the GDM. The Contractor shall provide a Drilled Foundation Installation Plan (DFIP) that shall also include which load test procedure will be used (i.e. static, rapid, or high strain). The test shaft shall have a minimum diameter of 48 inches. Load testing shall be performed within the limits of the proposed bridge stationing and shall have an offset of no more 50 feet from the proposed centerline. In addition, the test shaft shall be located a minimum of 25 feet from any future bridge drilled shaft foundation location. The test shaft shall also be located at least 25 feet from any existing bridge foundation and shall be positioned such that construction and testing operations do not adversely affect the existing bridge. The location shall avoid conflicts with any construction staging, necessary work trestle, and/or utilities.

2.2 Roadway

Design all new roadway structures required for the Project in accordance with the GDM. Geotechnical evaluation of new embankments shall be required in accordance with the GDM and applicable Bridge Design Memos. A monitoring program shall be required to verify that all new embankments or modified embankments meet performance limits established in the GDM. The Contractor shall obtain SCDOT approval prior to using reinforced soil slopes (RSS). The Contractor shall obtain SCDOT approval prior to using fill slopes or ditch slopes steeper than 2H:1V.

Miscellaneous overhead structure foundations such as lighting and signage shall be designed in accordance with AASHTO Standard Specifications for Structural Supports for Highway Signs, Luminaires, and Traffic Signals, effective as of the Final RFP release date.

2.3 Seismic

Seismic design of the bridge structures, roadway structures, and bridge embankments shall be required in accordance with the SCDOT Geotechnical Design Manual and SCDOT Seismic Design Specifications for Highway Bridges.

Seismic evaluation is required for all bridge embankments, regardless of fill height. Seismic evaluation is not required for roadway embankments on this Project.

The Simplified Newmark method described in Section 13.17.2 and Equation 13-106 of the GDM shall be used to analyze seismic ground displacements along a shear plane. Calculated Newmark displacements shall be multiplied by 2 for all ROC I and ROC II embankments and roadway structures.

A one-dimensional non-linear site-specific response analysis (SSRA) has been performed for this project by F&ME. The SSRA report dated March 10, 2017 is attached in Appendix C for information only. Based on the SSRA report, single ADRS curves for the SEE and FEE design events have been developed for all structures bearing on deep foundations extending to or into the limestone and are supplied in this design criteria. Separate ADRS curves for the SEE and FEE design events are provided at the ground surface for embankment and roadway structure design for both the begin bridge and end bridge sections. The ADRS curves are provided below and shall be used for all seismic design on the Project. The provided curves are the final design curves for the Project. Submittal of ATC's for site-specific site response analyses will not be approved.

US 21 over Harbor River – Ground Surface, Begin Bridge

Design EQ	PGA	S _{DS}	S _{D1}
FEE	0.14	0.38	0.14
SEE	0.26	0.74	0.74

US 21 over Harbor River – Ground Surface, End Bridge

Design EQ	PGA	S _{DS}	S _{D1}
FEE	0.12	0.26	0.17
SEE	0.29	0.58	0.58

US 21 over Harbor River – Top of Limestone

Design EQ	PGA	S _{DS}	S _{D1}
FEE	0.07	0.17	0.08
SEE	0.29	0.77	0.42

EXHIBIT 4f – GEOTECHNICAL DESIGN CRITERIA

US 21 over Harbor River
 Site-Specific ADRS Curves From Ground Surface
 Begin Bridge Embankments

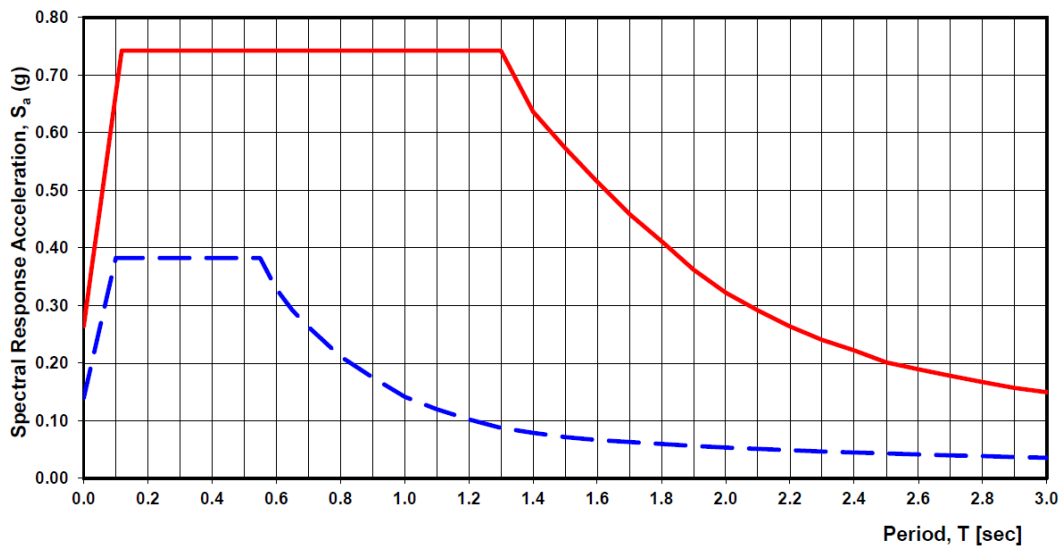

FEE ADRS Curve
 Site-Specific

T	S _a
0.00	0.140
0.05	0.261
To 0.10	0.383
0.15	0.383
0.20	0.383
0.25	0.383
0.30	0.383
0.40	0.383
0.50	0.383
Ts 0.55	0.383
0.60	0.329
0.65	0.292
0.70	0.263
0.80	0.211
0.90	0.175
1.00	0.142
1.10	0.120
1.20	0.102
1.30	0.087
1.40	0.079
1.50	0.071
1.60	0.067
1.70	0.063
1.80	0.059
1.90	0.056
2.00	0.053
2.10	0.051
2.20	0.049
2.30	0.047
2.40	0.045
2.50	0.043
2.60	0.042
2.70	0.040
2.80	0.038
2.90	0.037
3.00	0.036

SEE ADRS Curve
 Site-Specific

T	S _a
0.00	0.264
0.03	0.365
0.05	0.466
To 0.12	0.742
0.15	0.742
0.20	0.742
0.25	0.742
0.30	0.742
0.35	0.742
0.40	0.742
0.50	0.742
0.60	0.742
0.70	0.742
0.80	0.742
0.90	0.742
1.00	0.742
1.10	0.742
1.20	0.742
Ts 1.30	0.742
1.40	0.636
1.50	0.573
1.60	0.515
1.70	0.459
1.80	0.412
1.90	0.362
2.00	0.322
2.10	0.291
2.20	0.264
2.30	0.241
2.40	0.222
2.50	0.201
2.60	0.189
2.70	0.178
2.80	0.167
2.90	0.157
3.00	0.149

EXHIBIT 4f – GEOTECHNICAL DESIGN CRITERIA

**US 21 over Harbor River
Site-Specific ADRS Curves From Ground Surface
End Bridge Embankments**

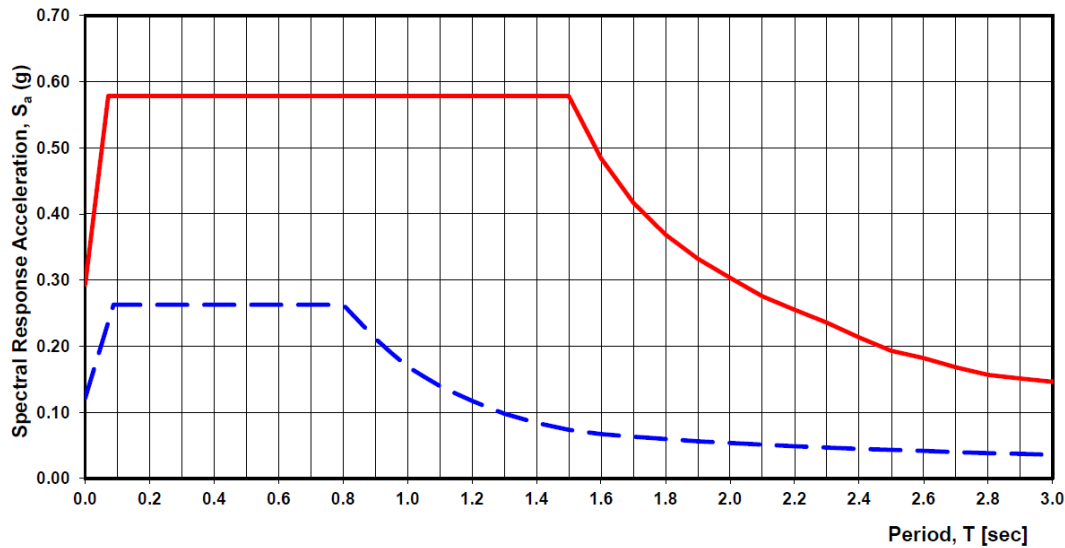

**FEE ADRS Curve
Site-Specific**

	T	S_a
	0.00	0.122
T_o	0.09	0.262
	0.20	0.262
	0.30	0.262
	0.40	0.262
	0.50	0.262
	0.60	0.262
	0.70	0.262
T_s	0.80	0.262
	0.90	0.211
	0.95	0.190
	1.00	0.169
	1.05	0.154
	1.10	0.140
	1.15	0.128
	1.20	0.117
	1.25	0.107
	1.30	0.098
	1.35	0.091
	1.40	0.084
	1.50	0.074
	1.60	0.067
	1.70	0.063
	1.80	0.059
	1.90	0.056
	2.00	0.053
	2.10	0.051
	2.20	0.049
	2.30	0.047
	2.40	0.045
	2.50	0.043
	2.60	0.042
	2.70	0.040
	2.80	0.038
	2.90	0.037
	3.00	0.036

**SEE ADRS Curve
Site-Specific**

	T	S_a
	0.00	0.293
T_o	0.07	0.578
	0.10	0.578
	0.15	0.578
	0.20	0.578
	0.25	0.578
	0.30	0.578
	0.35	0.578
	0.40	0.578
	0.45	0.578
	0.50	0.578
	0.60	0.578
	0.70	0.578
	0.80	0.578
	0.90	0.578
	1.00	0.578
	1.10	0.578
	1.20	0.578
	1.30	0.578
	1.40	0.578
T_s	1.50	0.578
	1.60	0.485
	1.70	0.417
	1.80	0.369
	1.90	0.332
	2.00	0.303
	2.10	0.276
	2.20	0.255
	2.30	0.236
	2.40	0.213
	2.50	0.193
	2.60	0.182
	2.70	0.168
	2.80	0.157
	2.90	0.151
	3.00	0.146

EXHIBIT 4f – GEOTECHNICAL DESIGN CRITERIA

US 21 over Harbor River
Site-Specific ADRS Curves
Top of Limestone

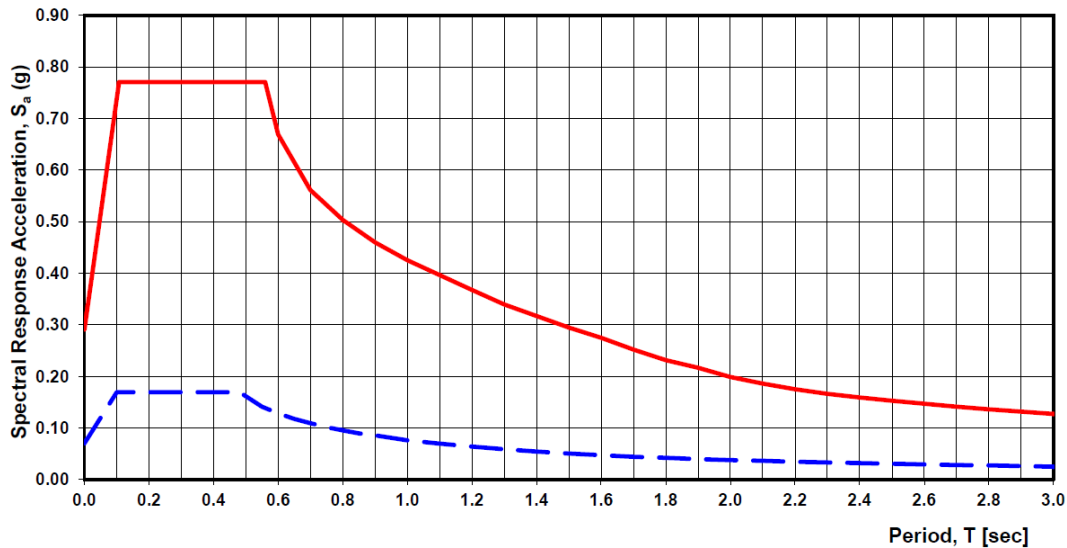

FEE ADRS Curve
Site-Specific

	T	S _a
	0.00	0.070
To	0.10	0.169
	0.20	0.169
	0.30	0.169
	0.40	0.169
	0.45	0.169
Ts	0.48	0.169
	0.55	0.141
	0.60	0.128
	0.65	0.117
	0.70	0.109
	0.75	0.102
	0.80	0.095
	0.85	0.090
	0.90	0.085
	1.00	0.076
	1.10	0.070
	1.20	0.064
	1.30	0.059
	1.40	0.054
	1.50	0.050
	1.60	0.047
	1.70	0.044
	1.80	0.042
	1.90	0.040
	2.00	0.038
	2.10	0.036
	2.20	0.035
	2.30	0.033
	2.40	0.032
	2.50	0.031
	2.60	0.029
	2.70	0.028
	2.80	0.027
	2.90	0.026
	3.00	0.025

SEE ADRS Curve
Site-Specific

	T	S _a
	0.00	0.292
To	0.11	0.770
	0.15	0.770
	0.20	0.770
	0.25	0.770
	0.30	0.770
	0.35	0.770
	0.40	0.770
	0.45	0.770
	0.50	0.770
Ts	0.56	0.770
	0.60	0.670
	0.70	0.561
	0.80	0.503
	0.90	0.459
	1.00	0.425
	1.10	0.396
	1.20	0.367
	1.30	0.339
	1.40	0.317
	1.50	0.295
	1.60	0.275
	1.70	0.252
	1.80	0.231
	1.90	0.217
	2.00	0.199
	2.10	0.186
	2.20	0.175
	2.30	0.166
	2.40	0.159
	2.50	0.153
	2.60	0.147
	2.70	0.141
	2.80	0.136
	2.90	0.132
	3.00	0.127

EXHIBIT 4g

ENVIRONMENTAL DESIGN CRITERIA

1.0 GENERAL COMMITMENTS

The Agreement, Article X, includes details related to Environmental Compliance. The National Environmental Policy Act (NEPA) documents and other environmental information are provided in Attachment B. The Contractor shall avoid impacts to the environment to the maximum extent practicable. In cases where impacts cannot be avoided, the Contractor shall minimize impacts to the environment to the most practicable extent. As a minimum the Contractor shall include the following in the Project:

- 1) The Contractor is responsible for the preparation, revision, acquisition, and adherence to conditions of any permits required by federal, state, local laws or regulations.
- 2) The Contractor is responsible for any modifications or revisions to the environmental documents and permits that result from deviations in the project design and environmental impacts as stated in the environmental documents.
- 3) The Contractor shall provide an Environmental Compliance Plan for the Project. The plan shall be submitted to South Carolina Department of Transportation (SCDOT; “The Department”) for review and approval prior to any construction activity. The plan shall identify all specific measures that the Contractor will implement to assure compliance with all federal, state and local laws and regulations including, but not limited to, environmental documents, permits, and environmental commitments. The plan shall also designate specific personnel that are charged with carrying out monitoring and compliance activities included in the Environmental Compliance Plan.
- 4) Fines assessed by any agencies to the Department as the result of the Contractor’s non-compliance or violation of said permit provisions shall be paid by the Department and subsequently deducted from the Contractor’s monthly pay estimate.
- 5) The Contractor shall coordinate all permitting through SCDOT’s Environmental Services Office.
- 6) Contractor responsible for providing a summary report documenting how all commitments that fall within his responsibility have been satisfied.

2.0 ENVIRONMENTAL DOCUMENT COMMITMENTS

The Contractor shall comply with all Environmental Commitments related to the Project. The following list of Environmental Commitments and instructions serves as a guideline for the relationship between SCDOT and the Contractor as it pertains to fulfilling the Environmental Commitments for the Project.

2.1 Finding of No Significant Impact (FONSI)

- 1) The contractor will be required to minimize possible water quality impacts through implementation of construction Best Management Practices (BMP), reflecting policies contained in 23 CFR 650B and the Department's *Supplemental Specifications on Seeding and Erosion Control Measures* (Latest Edition). Other measures including seeding, silt fences, sediment basins, etc., as appropriate, will be implemented during construction to minimize impacts to Water Quality. See Section 5.3 of the Environmental Assessment (EA).

Contractor's Responsibility

- 2) Stormwater control measures, both during construction and post-construction, are required for SCDOT projects with land disturbance and/or constructed in the vicinity of 303(d), Total Maximum Daily Load (TMDL), Outstanding Resource Waters (ORW), tidal, and other sensitive waters in accordance with the SCDOT's Municipal Separate Storm Sewer System (MS4) Permit. The selected contractor would be required to minimize potential stormwater impacts through implementation of construction BMPs, reflecting policies contained in 23 CFR 650 B and SCDOT's *Supplemental Specifications on Seed and Erosion Control Measures* (Latest Edition). See Section 5.3 of EA.

Contractor's Responsibility

- 3) The selected contractor will send a set of final plans and request for floodplain management compliance to the local County Floodplain Administrator. See Section 5.6 of EA.

Contractor's Responsibility

- 4) The federal Migratory Bird Treaty Act, 16 USC § 703-711 (MBTA), states that it is unlawful to pursue, hunt, take, capture or kill; attempt to take, capture or kill; possess, offer to or sell, barter, purchase, deliver or cause to be shipped, exported, imported, transported, carried or received any migratory bird, part, nest, egg or product, manufactured or not. SCDOT will comply with the Migratory Bird Treaty Act of 1918 in regard to the avoidance of taking of individual migratory birds and the destruction of their active nests. The contractor shall notify the Resident Construction Engineer (RCE) at least four (4) weeks prior to construction/demolition/maintenance of bridges and box culverts. The RCE will coordinate with SCDOT Environmental Services Office (ESO), Compliance Division, to determine if there are any active birds using the structure. After this coordination, it will be determined when construction/demolition/maintenance can begin. If a nest is observed that was not discovered after construction/demolition/maintenance has begun, the contractor will cease work and immediately notify the RCE, who will notify the ESO Compliance Division. The ESO Compliance Division will determine

the next course of action. The use of any deterrents by the contractor designed to prevent birds from nesting, shall be approved by the RCE with coordination from the ESO Compliance Division. The cost for any contractor provided deterrents will be provided at no additional cost to SCDOT. See Section 5.8 of EA.

Contractor/SCDOT Responsibility

- 5) Impacts to jurisdictional waters will be permitted under a Department of the Army Section 404 permit from the United States Army Corps of Engineers (USACE). Based on preliminary design, it is anticipated that the proposed project would be permitted under an Individual Army Corps of Engineers Permit (IP). SCDOT will provide USACE with information regarding any proposed demolition activities during the Section 404 permitting process. The required mitigation for this project will be determined through consultation with the USACE and other resource agencies. See Section 5.5 of EA.

Contractor/SCDOT Responsibility

Contractor is responsible for acquiring the Section 404 permit from the USACE. SCDOT will make available a maximum of 80 tidal credits from an approved mitigation bank. The Contractor is responsible for providing all additional mitigation credits that are required as a result of impacts to jurisdictional wetlands.

- 6) SCDOT will inform local planning officials of future, generalized noise levels expected to occur in the project vicinity after Federal Highway Administration (FHWA) has made a final decision on the Environmental document. See Section 5.14 of EA.

SCDOT Responsibility

- 7) If avoidance of hazardous materials is not a viable alternative and soils that appear to be contaminated are encountered during construction, the South Carolina Department of Health and Environmental Control (SCDHEC) will be informed. Hazardous materials will be tested and removed and/or treated in accordance with the United States Environmental Protection Agency (USEPA) and the SCDHEC requirements, if necessary. See Section 5.15 of EA.

Contractor's Responsibility

- 8) The contractor and subcontractors must notify their workers to watch for the presence of any prehistoric or historic remains, including but not limited to arrowheads, pottery, ceramics, flakes, bones, graves, gravestones, or brick concentrations during the construction phase of the project, if any such remains are encountered, the RCE will be immediately notified and all work in the vicinity of the discovered materials and site work shall cease until the SCDOT Archaeologist directs otherwise. See Section 5.16 of EA.

Contractor/SCDOT Responsibility

- 9) The SCDOT will acquire all of new right-of-way and process and relocations in compliance with the Uniform Relocation Assistance and Real Property Acquisition policies Act of 1970, as amended (42 U.S.C. 460 et seq.). The purpose of these regulations is to ensure that owners of real property to be acquired for Federal and federally-assisted projects are treated fairly and consistently, to encourage and expedite acquisition by agreements with such owner, to be minimize litigation and relieve congestion in the courts, and to promote public confidence in Federal and federally-assisted land acquisition programs. See Section 5.18 of EA.

Contractor's Responsibility

- 10) The selected contractor will be required to minimize impacts of siltation and erosion through implementation of BMPs. The contractor would develop an Essential Fish Habitat (EFH) Mitigation Plan during the Section 404 phase of the project. The EFH Mitigation Plan may include mitigation measures such as causeway removal, living shorelines, oyster bed restoration, and/or other methods of mitigating EFH impacts. The plan would include mitigation through the South Carolina Department of Natural Resources (SCDNR) South Carolina Oyster Restoration and Enhancement Program (SCORE) program for the 0.1 acre of impacts to oyster reefs. SCDOT will coordinate the mitigation plan and final design changes with National Oceanic and Atmospheric Administration-National Marine Fisheries Service (NOAA-NMFS). See Section 5.11 of EA.

Contractor's Responsibility with SCDOT coordination. SCDOT responsible for coordination and payment to SCORE for Oyster Restoration.

- 11) SCDOT will obtain authorization for the project construction activities under the SCDHEC National Pollutant Discharge Elimination System (NPDES) program, pursuant to Section 402 of the Clean Water Act. The NPDES permit application will include a Stormwater Pollution Prevention Plan (SWPPP). See Section 5.5 of EA.

Contractor Responsibility. Contractor ~~should~~ shall prepare and submit all necessary paperwork for permit and SCDOT will submit to agencies. Responsibility

- 12) The construction of the proposed Harbor River Bridge will require a United States Coast Guard (USCG) Bridge Permit in compliance with Section 9 of the Rivers and Harbors Act of 1899 and the General Bridge Act of 1946. Permit coordination will be carried out with the USCG for the design and construction of the Harbor River Bridge. See Section 5.5 of EA.

Contractor Responsibility

- 13) Qualified personnel hired by the contractor would survey the project area for bald eagle nests prior to initiating construction. Construction personnel would be qualified to identify eagles and nests, and instructed to report any sightings of potential nests to SCDOT. If a bald eagle nest is identified within 660 feet of the project prior to or during construction, SCDOT would re-initiate consultation with the United States Fish and Wildlife Service (USFWS) in accordance with the Bald and Golden Eagle Protection Act (BGEPA) and MBTA and would adhere to the USFWS National Bald Eagle Management Guidelines. The contractor will work with the SCDOT and USFWS to develop a Bald Eagle Zone Management Plan that would restrict construction work within 660 feet of the active nest during the nesting season, where practicable, and require the contractor to minimize noise, lighting, and night time work within the management zone. See Section 5.9 of the EA.

Contractor's Responsibility

- 14) Stormwater runoff from the proposed bridge and roadway would be treated prior to discharge into the waters surrounding Harbor River. Untreated stormwater runoff would not be discharged within 1,000 feet of a shellfish bed. SCDOT would submit a drainage plan to SCDHEC and Ocean and Coastal Resources Management (OCRM) prior to finalizing construction plans. See Section 5.3 of EA. *(Waters surrounding Harbor River include: Tidal Marsh/ Critical Area and Tidal Open Waters as referenced in Critical Area Plat)*

Contractor's Responsibility

- 15) If construction, including materials staging or stockpiling, would result in partial or full temporary closure of the boat ramp, the contractor would be responsible for coordinating the 4(f) use with the SCDOT, FHWA, and Beaufort County. See Section 5.17 of EA.

Contractor's Responsibility

- 16) Equipment and materials used during the construction of the bridge would not obstruct or impede passage through more than 50 percent of the channel. The channel is defined as the width of the waterway beneath the bridge at low tide. During construction, the potential effect of in-water noise impacts would be minimized through the use of vibratory hammers, where practicable, and “slow starts”. A “slow start” requires operators to provide an initial set of three strikes from the impact hammer, followed by a 1-minute waiting period, then two subsequent three-strike sets. The contractor would stop in-water work at night for a minimum of 8 hours. See Section 5.10 of EA.

Contractor's Responsibility

- 17) If explosives are used for demolition, the contractor would be required to hire qualified personnel to evaluate the potential effect on protected species to

submit to SCDOT. SCDOT would be responsible for re-initiating consultation with USFWS and NOAA-NMFS. The contractor would develop a blasting plan to include a marine wildlife watch plan to submit to SCDOT. See Section 5.10 of EA.

Contractor's Responsibility

- 18) The contractor would implement NOAA-NMFS *Sea Turtle and Smalltooth Sawfish Construction Conditions* (see EA Appendix H). The proposed bridge would not contain permanent roadway lighting. During the sea turtle nesting season (May 1 through October 31), the contractor would restrict in-water work at night to the maximum extent practicable. Nighttime is defined as 30-minutes after sunset to 30-minutes before sunrise. See Section 5.10 of EA. *(In-water work is defined as any activity that occurs in a tidally inundated area that could result in the physical destruction or alteration of marine habitats. (Examples: excavation, filling, pile driving, drilled shaft construction, installation of casings, drilling and/or auguring within casings.))*

Contractor's Responsibility

- 19) Between May 1 and October 31 (turtle nesting season), the contractor would use the minimum number and lowest wattage of lights that are necessary for construction. Lights would be positioned to focus on the work area to minimize the amount of light on the water surface. The contractor would turn off all lights when not needed during construction. See Section 5.10 of EA.

Contractor's Responsibility

- 20) The contractor would adhere to the established USFWS *Manatee Protection Guidelines*. See Section 5.10 of EA and Appendix G of EA.

Contractor's Responsibility

- 21) A Memorandum of Agreement (MOA) has been executed between FHWA, SCDOT, State Historic Preservation Office (SHPO), and South Carolina Department of Parks, Recreation, and Tourism (SCPRT). See Section 5.16 and Appendix M of EA. FHWA and SCDOT will ensure that the following stipulations are implemented:
- To mitigate adverse effects to the Harbor River Bridge, SCDOT will work with the SHPO, SCPRT, and the Hunting Island State Park manager to develop and fund a public interpretation plan related to the impact of Depression-era work programs on Hunting Island State Park and its associated landscape. The interpretation plan should include elements that relate to the construction of the US 21 roadway and bridge over Harbor River as well as the history of the Civilian Conservation Corps at Hunting Island State Park.
 - The draft public interpretation plan shall be developed within 6 months after

the execution of the MOA. Copies of the draft interpretation plan shall be provided to the FHWA, SHPO, and Hunting Island State Park Manager for review and comment. A final public interpretation plan that incorporates comments received from FHWA, SHPO, and the Hunting Island State Park Manager shall be developed within 60 days after receipt of comments.

- The components of the interpretation plan shall be developed and installed at the Hunting Island State Park within one (1) year of the production of the final interpretation plan.
- Bridge Placard: SCDOT will remove the existing bridge placard on the US 21 Bridge and provide it to SCPRT to be used as part of the interpretive plan developed for the park.
- SCDOT will consider options for reuse of the bridge through advertisement, relocation, or salvaging a section of the bridge for display within Hunting Island State Park.

SCDOT's responsibility with assistance from the Contractor regarding the bridge placard. ~~and potential salvage of a bridge section.~~ If it is determined that a portion of the bridge is to be salvaged for a public display, SCDOT may coordinate a plan with the Contractor through a negotiated change order or supplemental agreement. SCDOT is responsible for all other stipulations included in the MOA.

- 22) The contractor would adhere to the established USFWS *Manatee Protection Guidelines*. Guidelines can be found in Appendix G of EA. Equipment and materials used during the construction of the bridge would not obstruct or impede passage through more than 50 percent of the channel. The channel is defined as the width of the waterway beneath the bridge at low tide. During construction, the potential effect of in-water noise impacts would be minimized through the use of vibratory hammers, where practicable, and "slow starts". A "slow start" requires operators to provide an initial set of three strikes from the impact hammer, followed by a 1-minute waiting period, then two subsequent three-strike sets. The contractor would stop in-water work at night for a minimum of 8 hours. If explosives are used for demolition, the contractor would be required to hire qualified personnel to evaluate the potential effect on protected species to submit to SCDOT. SCDOT would be responsible for re-initiating consultation with USFWS and NOAA-NMFS. The contractor would develop a blasting plan to include a marine wildlife watch plan to submit to SCDOT. See Section 5.12 of EA.

Contractor's Responsibility

- 23) A survey for Asbestos Containing Materials (ACM) and Lead Based Paint (LBP) will be conducted on the US 21 bridge over the Harbor River. Survey findings and the potential removal of ACM or LBP would be coordinated with the SCDHEC Bureau of Air Quality, Asbestos Section prior to demolition of existing bridge. See Section 5.15 of EA

Contractor's Responsibility. If the ACM and LBP surveys provided by SCDOT are appropriate for this coordination, Contractor may use those surveys for this coordination.

2.3 NOAA NMFS Consultation Letter Conditions (Turtles and Sturgeon)

- 1) The applicant will ensure the use of SCDOT's BMPs for soil and erosion control, and develop a spill prevention and pollution control plan to minimize impacts to wetlands and the Harbor River.

Contractor's Responsibility

- 2) Turbidity curtains will be deployed (as necessary) in waters greater than 1-foot deep to contain suspended sediments until they settle back to the bottom, and silt fences would be used in waters less than 1-foot deep

Contractor's Responsibility

- 3) No more than 50 percent of the waterway will be obstructed by construction equipment.

Contractor's Responsibility

- 4) A "slow start" method will be used to initiate impact driving of piles. The "slow start" method involves slowly increasing the power of the impact hammer, and the noise it produces, over a pre-determined period of time to give marine species and opportunity to leave the work area.

Contractor's Responsibility

- 5) The applicant has agreed to implement NMFS's *Sea Turtle and Smalltooth Sawfish Construction Conditions*, dated March 23, 2006, and apply those conditions to shortnose and Atlantic sturgeon as well. See EA Appendix H.

Contractor's Responsibility

- 6) The applicant has agreed to a year-round restriction on nighttime work so that no in-water work occurs during at least 8 hours per night. *(In-water work is defined as any activity that occurs in a tidally inundated area that could result in the physical destruction or alteration of marine habitats. (Examples:*

excavation, filling, pile driving, drilled shaft construction, installation of casings, drilling and/or auguring within casings.))

Contractor's Responsibility

2.4 Essential Fish Habitat (EFH) Assessment and NOAA NMFS Consultation Letter Conditions

- 1) During project development, if the demolition of the existing bridge is deemed to require blasting, the contractor will provide a Demolition Plan to NOAA-NMFS for further EFH coordination and evaluation of potential impacts.

Contractor's Responsibility

- 2) The contractor would develop an EFH Mitigation Plan during the Section 404 phase of the project. SCDOT will coordinate the mitigation plan and final design changes with FHWA and NOAA-NMFS.

Contractor's Responsibility

- 3) Bridge construction access would be located in upland areas to the maximum extent practicable.

Contractor's Responsibility

- 4) The contractor would be required to minimize these actions through implementation of construction BMPs, reflecting policies contained in 23 CFR 650B and SCDOT's *Supplemental Specifications on Seeding and Erosion Control Measures* of August 15, 2001. In addition, no contaminants will be released into the water. SCDOT has emergency spill recommendations to the contractor in the event of an accident. If a leak is evident or a spill occurs, the contractor would be notified and would verify that it is mitigated as soon as practical by authorized personnel. Any unused or contaminated materials would be disposed of in accordance with federal, state, and local laws.

Contractor's Responsibility

- 5) SCDOT will require the contractor to reduce the amount of permanent fill in salt marsh habitat from the currently proposed 3.032 acres.

Contractor's Responsibility

- 6) SCDOT will require the contractor to remove some portion of the existing causeway and grade the removal areas to match elevations in adjacent marsh where marsh vegetation occurs.

Contractor's Responsibility

- 7) SCDOT commits to mitigating for the unavoidable impacts to EFH (shellfish habitat) by implementing a mitigation plan that would restore at least 0.1 acre of oyster habitat.

Contractor's responsibility to develop and revise the mitigation plan. SCDOT is responsible for coordination and payment to SCORE for the Oyster Restoration.

3.0 ENVIRONMENTAL COMMITMENTS SUMMARY REPORT

Prior to final completion, the Contractor shall prepare and submit to SCDOT an Environmental Commitment Summary Report that summarizes the Contractor's compliance with the above listed commitments and includes all supporting documentation for that specific commitment. The Contractor shall provide two hard copies and one PDF copy of the document.

EXHIBIT 4z

PROJECT DESIGN DELIVERABLES

1.0 GENERAL

This exhibit describes the makeup of submittal packages used for Design Review.

2.0 SUBMITTAL PACKAGES

Submittal Package Contents	Hard Copies
Preliminary Submittal Packages	
Preliminary Road Submittal Packages shall include:	1HS
<ul style="list-style-type: none"> • Preliminary Road Plans 	
<ul style="list-style-type: none"> • Preliminary Roadway Drainage Design Report 	
<ul style="list-style-type: none"> • Conceptual Work Zone Traffic Control Plans* 	
<ul style="list-style-type: none"> • Preliminary Road Geotech Report 	
Preliminary Bridge Submittal Packages shall include:	1 HS
<ul style="list-style-type: none"> • Preliminary Bridge Plans 	
<ul style="list-style-type: none"> • Preliminary Bridge Hydraulic Design Report 	
<ul style="list-style-type: none"> • Preliminary Seismic Design Summary Report 	
<ul style="list-style-type: none"> • Preliminary Bridge Geotech Report 	
Right-of-Way Submittal Packages	
Right of Way Submittal Packages shall include:	
<ul style="list-style-type: none"> • Right-of-Way Plans 	
<ul style="list-style-type: none"> • Conceptual Work Zone Traffic Control Plans* 	
<ul style="list-style-type: none"> • Right-of-Way Hydraulic Reports 	
Final Submittal Packages	
Final Road Submittal Packages shall include:	1 HS

EXHIBIT 4z – PROJECT DESIGN DELIVERABLES

<ul style="list-style-type: none"> • Final Roadway Plans 	
<ul style="list-style-type: none"> • Final Roadway Drainage Design Report 	
<ul style="list-style-type: none"> • Work Zone Traffic Control Plans 	
<ul style="list-style-type: none"> • Final Signal Plans 	
<ul style="list-style-type: none"> • Final Road Geotech Reports 	
Final Bridge Submittal Packages shall include:	1HS
<ul style="list-style-type: none"> • Final Bridge Plans 	
<ul style="list-style-type: none"> • Final Bridge Hydraulic Design Report 	
<ul style="list-style-type: none"> • Final Bridge Geotech Report 	
<ul style="list-style-type: none"> • Final Seismic Design Summary Report 	
RFC Submittal Packages	
RFC Road Submittal Packages shall include:	1 FS
<ul style="list-style-type: none"> • RFC Roadway Plans 	
<ul style="list-style-type: none"> • RFC Roadway Drainage Design Report 	
<ul style="list-style-type: none"> • RFC Work Zone Traffic Control Plans 	
<ul style="list-style-type: none"> • RFC Road Geotech Reports 	
RFC Bridge Submittal Packages shall include:	1 FS
<ul style="list-style-type: none"> • RFC Bridge Plans 	
<ul style="list-style-type: none"> • RFC Bridge Hydraulic Design Report 	
<ul style="list-style-type: none"> • RFC Bridge Geotech Report 	
<ul style="list-style-type: none"> • RFC Seismic Design Summary Report 	
Construction Submittals (including, but not limited to)**	

Traffic Management Plan	
Foundation Installation Plan Submittals	
Foundation Testing Submittals	
Hazardous Materials Testing Submittals	
Shop Plans	
Working Drawings	
NPDES Submittals	

* If ROW plans are not anticipated, these plans shall be included with the preliminary road plans.

** Reviews for these submittals are not held to the standard periods as outlined in Agreement Section II. D.3.

3.0 SUBMITTAL CONTENTS

3.1 All Submittals

- Partial submittal of the required contents of the preliminary, right of way, or final design review packages will not be allowed.
- Perform a thorough QC review of the submittals prior to submitting them to SCDOT.
- Advise SCDOT of all changes or additions made to plans after initial submittal of each phase (Preliminary and Final), if the revisions were not made to address SCDOT comments.
- Digital or inked signatures are allowable for RFC documents. However, only one method of signature, digital or inked, is allowed per Project ID.
- Plans shall be submitted electronically as a landscape 22"x36" pdf file.
- Reports shall be submitted electronically as a portrait 8.5"x11" pdf file. Larger sheets may be included for charts, diagrams, etc.

3.2 Traffic Management Plan

- The Contractor shall submit a Traffic Management Plan in accordance with the document, Rule on Work Zone Safety and Mobility: Implementation, Maintenance, and Safety Guidelines.
- All components of the Transportation Management Plan shall be submitted for review by SCDOT and must be approved before any construction activities can begin.

3.3 Preliminary Submittal Packages

3.3.1 Preliminary Road Plans

- The plans shall include, but not be limited to, the following:
 - title sheet
 - roadway typical section
 - strip map, including property closures
 - roadway plan and profile
 - cross sections
 - clearing limits on plan view and cross sections
 - drainage features
 - existing right-of-way
 - proposed right-of-way

3.3.2 Preliminary Bridge Plans

- The plans shall include, but not be limited to, all items described in Chapter 3 of the SCDOT Bridge Design Manual.

3.3.3 Preliminary Seismic Design Summary Report

- In the report, document the seismic design strategy that is planned to achieve the required seismic performance criteria for the bridge and describe the seismic design approach for the bridge. At a minimum, include the following:
 - a description of the project including bridge location(Longitude and Latitude), the geological and hydrological feature of the site, bridge preliminary configuration including layout, superstructure, substructure, bearing types, span lengths, end bent and interior bent type, skew angle, shear keys, expansion joints, wingwalls, backwalls, shearwalls etc,
 - The seismic design specifications,
 - The SEE,FEE Design Earthquakes, The ADRS data, the Operational classification, the Seismic Design Category (SDC),
 - The analysis strategy to capture the structure seismic performance, including seismic models to be analyzed, how structure elements are going to be modeled,
 - a discussion of the expected performance of the bridge in regard to elastic and inelastic behavior (locations where plastic hinging is expected), the expected service performance and damage levels,
 - displacement and ductility criteria, a description of design features required to meet the critical performance requirements of according to the SCDOT Seismic Design Specifications for Highway Bridges,
 - the name(s) of computer software that will be used for modeling,

- any unique structural and geotechnical issues affecting the seismic design, and the design response spectrum (when a site-specific study is required).
- If any changes to the seismic design strategy are made during the design process, modify the report and resubmit to SCDOT for review.

3.3.4 Preliminary Hydraulic Reports

- Preliminary Roadway Drainage Design Reports shall include, but not be limited to, the following:
 - Pre/post outfall summaries
 - HW/D summaries for crosslines
 - Open channel designs
 - Address permitting requirements
 - Field Investigation and Pipe Inspection Report
- Preliminary Bridge Hydraulic Design Reports shall include, but not be limited to, the following:
 - Preliminary Hydraulic Model Design and Supporting Documentation including Hydrology Data Sheets, the Hydraulic Design and Risk Assessment Form, and the NEPA Bridge Replacement Scoping Trip Risk Assessment Forms (for each applicable location)
 - Modeling files
 - Address permitting requirements (for each applicable location)
- NPDES permitting-if permitting is going to be phased, address how submittals will be phased and anticipated submission schedules

3.3.5 Preliminary Road & Bridge Geotechnical Reports

- The geotechnical reports shall include, but not be limited to, the following:
 - all items described in Chapter 21 of the SCDOT Geotechnical Design Manual and the latest design memorandums

3.4 Right-of-Way Submittal Packages

3.4.1 Right-of-Way Plans

- The plans shall include, but not be limited to, the following:
 - title sheet
 - roadway typical section
 - strip map, including property closures
 - right-of-way data sheet
 - roadway plan and profile
 - cross sections

- clearing limits on plan view and cross sections
- drainage features
- existing right-of-way
- proposed right-of-way

3.4.2 Conceptual Work Zone Traffic Control Plans

- The plans shall include, but not be limited to, the following:
 - Staging Narrative
 - Concept Staging Plans
 - Widening/Rehabilitation Typical Sections for each Stage of Construction and any critical points
 - Where additional Right-of-Way is warranted for the purposes of Staging
 - Separation of Adjacent Travel Lanes / Traffic Splits as described in the SCDOT Procedures and Guidelines for Work Zone Traffic Control Design
 - Where the travel lane leaves the existing roadway bed or direction on new alignment (transition area) and returns (termination area)

3.4.3 Right-of-Way Hydraulic Reports

- Roadway Drainage Design Reports shall include, but not be limited to, the following:
 - Updates to the preliminary roadway drainage designs
 - Inlet spacing calculations and bridge deck drainage calculations
 - Geopak drainage summaries
 - Storm sewer system profiles for the design storm and the 50-yr event at sag locations
 - Sediment and erosion control designs
 - Water quality and post construction designs
 - Detention designs and supporting documentation
- NPDES package shall be provided for review in preparation for submittal to SCDHEC/OCRM

3.5 Final Submittal Packages

3.5.1 Final Road Plans

- The plans shall include, but not be limited to, the following:
 - title sheet
 - roadway typical section
 - strip map, including property closures
 - right-of-way data sheet
 - roadway plan and profile

- cross sections
- clearing limits on plan view and cross sections
- drainage design
- existing right-of-way
- proposed right-of-way
- summary of estimated quantities
- strip map including property closures
- sediment and erosion control design
- proposed barrier locations
- permanent signing plans
- permanent pavement markings plans
- traffic signal plans
- work zone traffic control plans

3.5.2 Final Hydraulic Report

- Final Roadway Drainage Design Reports shall include, but not be limited to, the following:
 - Updates to the Right-of-Way hydraulic drainage designs
- Final Bridge Hydraulic Design Reports shall include, but not be limited to, the following:
 - Final Hydraulic Model Design and Supporting Documentation including all updated forms
 - Final Modeling files
 - Scour Study- additionally plot the 100- and 500-year lines on the bridge triple profile sheet (for each applicable location)
 - Address CLOMR and/or “No Impact” Certifications (for each applicable location)
 - Include the hydrology data for bridges, culverts and pipes greater than 48 inches on the bridge triple profile sheets
- Complete NPDES package

3.5.3 Final Bridge Plans

- Include in the Final Bridge Plans, at a minimum, all items described in Chapters 3 and 6 of the SCDOT Bridge Design Manual. Partial submittal of the required contents of the final set of plans will not be allowed for this project. However, the Contractor may divide the bridge into segments, with each segment having a stand-alone final set of plans which accounts for interaction of adjacent segments.

3.5.4 Final Seismic Design Summary Report

- In the report, describe the seismic design approach for the bridge. At a minimum, include the following:

- a project description,
- the required Seismic Design Specifications,
- seismic design criteria and objectives, including Operational Classification, design earthquake(s), ADRS, and SDC,
- expected service performance and damage levels,
- seismic design approach and strategy ~~criteria~~ to achieve the required seismic performance; including seismic load path, potential plastic hinges, and any unique aspects of the project,
- liquefaction assessment and any geotechnical recommendations,
- seismic analysis/design software used in the project (include discussions regarding the structural and geotechnical modeling aspects for the bridge),
- mass participation ~~achieved~~, longitudinal and transverse fundamental periods, and
- tabulated results ~~for~~from the design earthquake(s) tension and compression models ~~and pushover models~~ as applicable for variations of liquefaction and scour including:
 - displacement demand
 - yield displacement
 - displacement capacity
 - displacement performance limits
 - displacement capacity check
 - ductility demand check
 - ductility capacity check
- seismic detailing, including design of cap support length, hinge region detailing, shear keys, anchor bolts, bearings, wingwalls, backwalls, shear walls, etc.

3.5.5 Final Road & Bridge Geotechnical Reports

- The geotechnical reports shall include, but not be limited to, the following:
 - all items described in Chapter 21 of the SCDOT Geotechnical Design Manual and the latest design memorandums
 - design details and plan notes along with data that are consistent with that shown in the final bridge and road plans
 - Contractor's designer shall prepare the required geotechnical bridge and roadway plan sheets that clearly detail any geotechnical requirements outlined in the reports

3.6 RFC Submittal Packages

- RFC plans shall be submitted once all comments have been closed on all submittals for each phase (ex. Preliminary/ROW/Final/RFC) of a segment or structure and a request for RFC plans has been issued by the Construction Office.
- After all comments are closed, no changes shall be made to the plans before submitting RFC plans.
- Insert RFC Plans into plan folders as detailed in the SCDOT Plan Preparation Guide and the SCDOT Bridge Design Manual if not submitted with digital signatures.
- The Engineer of Record, a licensed and registered Professional Engineer in the State of South Carolina, shall sign and seal all RFC submittals and all final reports. RFC Plans shall be original documents if not submitted with digital signatures.
- RFC plans submitted with digital signatures shall comply with the SCDOT Digital Signatures Manual.
- Provide electronic copy of all Final Design Calculations to SCDOT prior to or along with the submittal of RFC plans

3.7 Revisions to RFC Plans

- After submittal of RFC plans, any subsequent changes to the design plans will be considered revisions. Revisions shall be denoted as detailed in the design manuals or as directed by the Department.

3.8 NPDES Submittals

- The appropriate level of design and review shall be completed prior to any NPDES package submittal.

3.9 Foundation Installation Plan Submittals

- Prepare Drilled Foundation Installation Plans (DFIP) and/or Pile Installation Plans (PIP) in accordance with the SCDOT Standard Specifications for Highway Construction, 2007 Edition. Submit all foundation installation plan submittals electronically. The Contractor's designer shall review and approve all DFIP and PIP (including pile driving criteria) prior to submitting the foundation installation plans to SCDOT for review and acceptance. SCDOT will review the foundation installation plans and provide either acceptance or comments. The Contractor's designer shall resolve all comments prior to re-submittal to SCDOT. SCDOT will review the DFIP and/or the PIP only to verify that the specifications have been addressed. The Contractor shall provide a supplement to the report containing the actual field conditions encountered and as-built foundation data and information after construction of the foundations is complete.

3.10 Work Zone Traffic Control Plans

- The plans shall be in accordance with the SCDOT Procedures and Guidelines for Work Zone Traffic Control Design and all other applicable design references listed in Exhibit 4.

3.11 Revised Permit Drawings

- Contractor shall provide to SCDOT revised permit drawings that show ROW limits that differ from those in the approved USACE Permit.

3.12 Shop Plans

- Submit shop plans, as defined by the Standard Specifications for Highway Construction, to the Contractor's designer for review and approval. Route all approved shop plans to SCDOT for review and distribution. Provide shop plan submittals that meet the criteria of Subsection 725.1.1 of the Standard Specifications for Highway Construction. After reviewing the plans, SCDOT will either distribute the plans or provide comments. If comments are provided, the Contractor's designer shall review the comments prior to resubmitting to the SCDOT for further review. The Contractor's designer shall stamp the shop plans "approved" prior to submittal to SCDOT. SCDOT will stamp and distribute the plans. Do not commence fabrication and construction/erection until after SCDOT distributes the plans. The responsible engineer, registered as a Professional Engineer in the State of South Carolina, shall seal, sign, and date all design calculations and shop plans.

3.13 Working Drawings

- Submit working drawings and design calculations, as defined by the Standard Specifications for Highway Construction, to the Contractor's designer for review and approval. Route all approved working drawings and design calculations to the SCDOT for review and distribution. Provide working drawings and design calculation submittals that meet the criteria of Subsection 725.1.2 of the Standard Specifications for Highway Construction. SCDOT will review the drawings and calculations and either provide acceptance of the drawings as prepared or provide comments. If comments are provided, the Contractor's designer shall review the comments prior to resubmittal to SCDOT for further review. The Contractor's designer shall stamp the working drawings and design calculations "approved" prior to submittal to SCDOT. SCDOT will stamp and distribute the drawings and calculations. Do not commence construction/erection until after SCDOT distributes the drawings and calculations. The responsible engineer, registered as a Professional Engineer in the State of South Carolina, shall

seal, sign, and date all design calculations and working drawings. SCDOT will review the working drawings and design calculations only to verify that the specifications have been addressed.

3.14 Foundation Testing Submittals

- Submit to SCDOT an electronic copy of all applicable foundation testing reports for all bridge and roadway structures to include but not limited to Shaft Load Test and Pile Driving Analyzer test reports.

3.15 Hazardous Materials Testing Submittals

- The Contractor shall submit to SCDOT:
 - Results of any hazardous materials analytical testing of sampled or excavated subsurface materials as outlined in the Agreement.
 - Manifests of all hazardous materials requiring disposal.

3.16 As-Built Signing Plans

- A complete as-built set of signing plans, including SignCAD copies of all layouts, shall be submitted to the SCDOT as directed by the Director of Traffic Engineering at the conclusion of the project.

3.17 As-Built Signal Plans

- Provide As-Built “red-lined” signal plans to the District Signal Shop after the signal work is completed.

EXHIBIT 5

SPECIAL PROVISIONS AND CONTRACT REQUIREMENTS

Table of Contents

SPECIAL PROVISIONS	3
(1) SECTION 101: STANDARD DRAWINGS:	3
(2) SECTION 102: IMMINENT STANDARD DRAWINGS	3
(3) SECTION 102: STANDARD DRAWING ERRATA:.....	3
(4) SECTION 103: BONDS AND INSURANCE:	5
(5) SECTION 103: MOBILIZATION – SUBCONTRACTOR:.....	5
(6) SECTION 104: OPERATION AND MAINTENANCE OF EXISTING FACILITIES:	5
(7) SECTION 106: SOURCE OF PRODUCTION OF IRON AND STEEL PRODUCTS:.....	6
(8) SECTION 106: SOURCE OF SUPPLY AND QUALITY OF MATERIALS:	6
(9) SECTION 106: PLANT/FABRICATOR INSPECTION:	6
(10) SECTION 106: QUALIFIED PRODUCT LISTINGS:	6
(11) SECTION 106: SOUTH CAROLINA MINING ACT:.....	7
(12) SECTION 107: PROJECT BULLETIN BOARDS:.....	7
(13) SECTION 107: FAIR LABOR STANDARDS ACT OF 1938, AS AMENDED:	7
(14) SECTION 107: CARGO PREFERENCE ACT REQUIREMENTS:	7
(15) SECTION 107: CONTRACT PROVISION TO REQUIRE CERTIFICATION AND COMPLIANCE CONCERNING ILLEGAL ALIENS:.....	8
(16) SECTION 107: IRAN DIVESTMENT ACT:	8
(17) SECTION 107: APPLICATION OF DAVIS-BACON AND RELATED ACTS TO INDEPENDENT TRUCK DRIVERS AND MISCELLANEOUS CONSTRUCTION ACTIVITIES:	9
(18) SECTION 107: REQUIREMENTS FOR FEDERAL AID CONTRACTS WHICH AFFECT SUBCONTRACTORS, DBE HAULERS, MATERIAL SUPPLIERS AND VENDORS:.....	10
(19) SECTION 107: DISADVANTAGED BUSINESS ENTERPRISES (DBE) GOALS AND REQUIREMENTS:.....	10
(20) SECTION 107: LATE DISCOVERY OF ARCHAEOLOGICAL/HISTORICAL REMAINS ON FEDERAL AID PROJECTS AND APPROVAL OF DESIGNATED BORROW PITS:.....	13
(21) SECTION 107: SPECIFIC EQUAL EMPLOYMENT OPPORTUNITY RESPONSIBILITIES TRAINING SPECIAL PROVISIONS:	13
(22) SECTION 107: MONITORING OF CONSTR.-RELATED EARTHBORNE VIBRATIONS:	16
(23) SECTION 107: COMMUNITY AND PUBLIC RELATIONS PLAN:	18
(24) SECTION 108: PARTNERING:	20
(25) SECTION 109: FUEL ADJUSTMENT INDEXES:	20
(26) SECTION 109: REFERENCES TO UNIT PRICING:.....	20
(27) SECTION 202: SALVAGE OF EXISTING BRIDGE COMPONENTS:	20
(28) SECTION 202: REMOVAL OF EXISTING GUARDRAIL:	21
(29) SECTION 202: RECLAIMING EXISTING ROADWAY:	21
(30) SECTION 203: BORROW EXCAVATION:	21
(31) SECTION 203: BORROW EXCAVATION (FOR SHOULDERS):	22
(32) SECTION 203: BORROW PITS:	23
(33) SECTION 203: MUCK EXCAVATION:	23
(34) SECTION 204: TEMPORARY SHORING WALL:	25
(35) SECTION 205: LIGHTWEIGHT AGGREGATES:.....	26
(36) SECTION 205: HIGH-STRENGTH GEOTEXTILE FOR EMBANKMENT REINFORCEMENT:	28
(37) SECTION 205: MONITORING DEVICES – PIEZOMETER:	35
(38) SECTION 205: SETTLEMENT SENSORS:.....	36
(39) SECTION 205: VIBRATING WIRE ROD EXTENSOMETER:	40
(40) SECTION 205: VIBRATING WIRE DATA COLLECTION CENTERS:	43
(41) SECTION 205: VIBRO COMPACTION:.....	46
(42) SECTION 205: DEEP SOIL MIXING (DSM):	49
(43) SECTION 205: GROUND MODIFICATION – COMPACTION GROUTING COLUMNS:.....	72

EXHIBIT 5 – SPECIAL PROVISIONS AND CONTRACT REQUIREMENTS

(44)	SECTION 305: MAINTENANCE STONE:	78
(45)	SECTION 306: CEMENT MODIFIED RECYCLED BASE:	78
(46)	SECTION 401: ASPHALT BINDER ADJUSTMENT INDEX:	79
(47)	SECTION 401: DRESSING OF SHOULDERS:.....	79
(48)	SECTION 401: HOT MIX ASPHALT (HMA) QUALITY ASSURANCE:.....	79
(49)	SECTION 401: HOT-MIX ASPHALT RIDEABILITY:	79
(50)	SECTION 401: FULL DEPTH ASPHALT PAVEMENT PATCHING:	79
(51)	SECTION 403: PAVING UNDER GUARDRAIL:	80
(52)	SECTION 403: WARM MIX ASPHALT – ASPHALT INTERMEDIATE COURSE TYPE B (SPECIAL):.....	85
(53)	DIVISION 600: FURNISH AND INSTALL DETECTOR LOOPS:	85
(54)	DIVISION 600: MANUAL ON UNIFORM TRAFFIC CONTROL DEVICES:.....	85
(55)	DIVISION 600: EVALUATION OF RETROREFLECTIVITY:	85
(56)	SECTION 601: PENALTY FOR VIOLATING LANE CLOSURE RESTRICTIONS:	86
(57)	SECTION 605: PERMANENT CONSTRUCTION SIGNS:	86
(58)	SECTION 610: WORK ZONE TRAFFIC CONTROL PROCEDURES:	86
(59)	SECTION 653: RETROREFLECTIVE SIGN POST PANELS:	87
(60)	DIVISION 700: ANTI-GRAFFITI COATING:	88
(61)	SECTION 701: SAND LIGHTWEIGHT CONCRETE:	89
(62)	SECTION 701: NON-CONFORMING CONCRETE:.....	91
(63)	SECTION 701: DRILLED SHAFT CONCRETE CLASS 4000DS - MASS CONCRETE MIX DESIGN	91
(64)	SECTION 702: MASS CONCRETE PLACEMENT	91
(65)	SECTION 704: PRESTRESSED CORED SLABS:.....	92
(66)	SECTION 711: PILE AND DRIVING EQUIPMENT DATA FORM:.....	92
(67)	SECTION 711: GALVANIZED STEEL H PILING AND SWAY BRACES:	92
(68)	SECTION 711: DRIVEN PILES	93
(69)	SECTION 712: DRILLED SHAFT FORMS:	93
(70)	SECTION 712: CONCRETE PLACEMENT AND TEMPERATURE CONTROL FOR LARGE DIAMETER DRILLED SHAFTS	93
(71)	SECTION 714: SMOOTH WALL PIPE:.....	94
(72)	SECTION 714: PIPE END TREATMENTS (2/5/2010):.....	96
(73)	SECTION 714: TRENCHLESS PIPE INSTALLATION:	99
(74)	SECTION 719: CAST IN PLACE CONCRETE PIPE COLLAR:.....	105
(75)	SECTION 727: CROSSHOLE SONIC LOGGING OF DRILLED SHAFT FOUNDATIONS:	105
(76)	SECTION 727: CROSSHOLE SONIC LOGGING AND THERMAL INTEGRITY PROFILING OF DRILLED SHAFT FOUNDATIONS	105
(77)	SECTION 729: NAVIGATION LIGHTS FOR BRIDGE.....	106
(78)	DIVISION 800: GEOTEXTILE FOR DRAINAGE FILTRATION:	110
(79)	DIVISION 800: GEOCOMPOSITE WALL DRAIN:	112
(80)	SECTION 805: THREAD LOCKING GUARDRAIL HARDWARE:	115
(81)	SECTION 805: TL3 TYPE T TANGENT END TERMINALS:.....	115
(82)	SECTION 805: RESETTING GUARDRAIL:.....	115
(83)	SECTION 806: REPAIR EXISTING CONTROL OF ACCESS FENCE:	116
(84)	SECTION 809: RIGHT OF WAY PLAT:	116
(85)	SECTION 815: ANIONIC POLYACRYLAMIDE FOR EROSION CONTROL:.....	117
(86)	SECTION 815: EROSION CONTROL MEASURES:	118
	REQUIRED CONTRACT PROVISIONS FEDERAL-AID CONSTRUCTION CONTRACTS.....	121
	STANDARD FEDERAL EQUAL EMPLOYMENT OPPORTUNITY CONSTRUCTION CONTRACT SPECIFICATIONS.....	133
	GENERAL DECISION NUMBER SC47	136

SPECIAL PROVISIONS

(1) SECTION 101: STANDARD DRAWINGS:

The Bidders are hereby advised that this project shall be constructed using the Current Standard Drawings with all updates effective at the time of this letting. For this design-build project, the time of the letting is the most recent Standard Highway Letting that occurred on or before the Final RFP release date. The Standard Drawings are available for download at http://www.scdot.org/doing/sd_Disclaimer.aspx. All drawings that are updated are labeled with their effective letting date in red.

The Standard Drawings are available to purchase through the SCDOT Engineering Publications Sales Center. The Engineering Publication Sales Center is located in Room 122 (College Street Entrance) of the SCDOT Headquarters Building, 955 Park Street, Columbia, South Carolina.

All references in the plans, standard specifications, supplemental specifications, supplemental technical specifications or special provisions to drawings under the previous numbering system are hereby updated to the new drawing numbers. Refer to sheets 000-205-01 through 000-205-07 to find new drawing numbers when looking for references to older drawing numbers. "Old sheet numbers" are also visible on the website when using the full set of drawings "current" search and are sortable by clicking the header over the appropriate column on the results page. Be aware that some older drawings now span over multiple pages due to detailing changes.

(2) SECTION 102: IMMINENT STANDARD DRAWINGS

On the Standard Drawings search page, enter status of Imminent with other fields blank to see a list of upcoming Standard Drawings and their corresponding effective let date. Imminent drawings may be used at any time they are available if approved by the Resident. Follow procedure shown in imminent drawings when noted in this section.

No imminent drawings are currently required on this project, but contractor is encouraged to review available imminent drawings for bidding upcoming projects.

(3) SECTION 102: STANDARD DRAWING ERRATA:

The Bidders are hereby advised that the following note changes apply to the published Standard Drawings.

On sheet **000-205-05**, add the following information under the columns below:

OLD DRAWING NAME	NEW DRAWING NAME
720-905-01 to 720-905-05	720-901-01 to 720-993-32

On sheet **605-005-05 (ver 1-1-2013)**, replace entire text of General Note #4 with the following text:

4. The square footage of sign panels attached to 2½" x 2½" 12 gauge sign support secured to a 3" x 3" 7 gauge breakaway anchor shall not exceed 20 square feet.

On sheet **720-305-00 (ver May 2008)**, delete the entire note directly above main detail:

If sidewalk exists, the driveway opening should...

On sheet **720-405-00 (ver May 2009)** Detail 2 replace dimension 2'-6" maximum with:

2'-6" minimum

On sheet **720-901-01 (ver Feb 2015)** replace note 5.04 with:

EXHIBIT 5 – SPECIAL PROVISIONS AND CONTRACT REQUIREMENTS

5.04 When a mid-block crossing is required, consider mid-block staggered crossing (720-955-41) to encourage eye contact between the pedestrian and the oncoming traffic. Always angle the stagger so that the pedestrian travels through the refuge facing the oncoming traffic.

On sheet 722-305-00 (ver May 2010) Detail 4 replace note “French Drain see note 21” with:
French Drain see note 4.5.

On sheet 722-305-00 (ver May 2010) table 722-305A, 4th column, change the following:

Delete (SF)

Replace text “up to 36” with “up to 3’X3’ ”

Replace text “larger than 36” with “larger than 3’X3’ ”

On sheet 804-105-00 (ver May 2008) Title Block replace text “Rirap (Bridge End)” with:

Riprap (Bridge End)

On sheet 805-325-00 (ver Jan 2011) detail 2 replace text “rectangular washers (FWR03) See 805-005-00” with:

“rectangular washers (FWR03) See 805-090-00”

On sheet 805-325-00 (ver Jan 2011) change text of note 5 to the following:

5. For project specific requirements such as additional offset blocks, extra length posts, and post attachment details, see Project Plans. Include all costs of project specific requirements in the Guardrail Thrie-Beam Bridge Connector pay item.

On sheet 805-330-00 (ver Jan 2011) detail 2 replace text “rectangular washers (FWR03) See 805-005-00” with:

“rectangular washers (FWR03) See 805-090-00”

On sheet 805-330-00 (ver Jan 2011) change text of note 4 to the following:

4. For project specific requirements such as additional offset blocks, extra length posts, and post attachment details, see Project Plans. Include all costs of project specific requirements in the Guardrail Thrie-Beam Bridge Connector pay item.

On sheet 805-510-00 (ver Jan 2011) detail 3 replace guardrail base plate note with the following:

See standard drawings 805-655-xx for guardrail base plate options.

On sheet 805-655-M1 (ver Jan 2011) replace note 30.4 with the following:

30.4 Install adhesive anchors to a depth sufficient to develop a minimum factored (reduced) ultimate tensile capacity of 21 kips per anchor bolt. Increase minimum embedment shown in detail 4 as required by adhesive manufacturer’s recommendations for the existing material properties, anchor bolt pattern, edge conditions, and any other design reduction.

On sheet 815-002-00 (ver Jan 2013) Type B, D1, & D2 Inlet Structure Filters, revise as follows:

Replace all references to #5 stone with #5 or #57 stone.

Payment for either #5 or #57 stone will be made under the pay item for **Aggregate No. 5 for Erosion Control (6 “ Uniform)**

EXHIBIT 5 – SPECIAL PROVISIONS AND CONTRACT REQUIREMENTS

(4) SECTION 103: BONDS AND INSURANCE:

Bonds and Insurance consists of all Bonds and Insurance required of the contractor. A maximum allowable amount of 2.0% of the total contract amount will be paid on the first pay estimate after work begins. If there is a remaining amount of the lump sum price for Bonds and Insurance after payments are made according to the limit above, then the remaining amount will be paid on the final estimate.

If special insurance is required by the contract provisions, such as railroad or coastal insurance, no maximum limit will apply to this bid item.

Item No.	Pay Item	Unit
1032010	BONDS AND INSURANCE	LS

(5) SECTION 103: MOBILIZATION – SUBCONTRACTOR:

Mobilization – Subcontractor consists of the preparatory operations for subcontractors including: moving personnel and equipment to the project site; paying bond and insurance premiums; establishing offices, buildings, and other facilities necessary for work on the project; and all other preparatory work or costs incurred before beginning work on the project.

Mobilization - Subcontractor is paid at the lump sum price bid, which price and payment is full compensation for organizing and moving all subcontractor forces, supplies, equipment and incidentals to the project site, regardless of the number of times such moves are made. The price and payment also includes costs for demobilization.

When the item Mobilization – Subcontractor is included in the bid items, payment will be made on the first four construction estimates. Each payment is for 25% of the lump sum price for Mobilization - Subcontractor, subject to the maximum total limit of 5.0% of the total contract amount.

If there is a remaining amount of the lump sum price for Mobilization after payments are made according to the limit above, then the remaining amount is paid after all work on the project has been completed and accepted.

Partial payment for this item in no way acts to preclude or limit any of the provisions of partial payments otherwise provided for by the Contract or these specifications.

Payment for this item includes all direct and indirect costs and expenses required to complete the work.

Pay items under this section include the following:

Item No.	Pay Item	Unit
1031100	MOBILIZATION – SUBCONTRACTOR	LS

(6) SECTION 104: OPERATION AND MAINTENANCE OF EXISTING FACILITIES:

The Contractor shall maintain highway traffic throughout the project and shall maintain the navigational requirements of the USCG throughout the project. SCDOT will operate and maintain the existing bridge during construction while the existing bridge remains open for public use. The limits of SCDOT maintenance shall be from the begin bridge station to end bridge station as shown on the existing roadway plans contained in Attachment C. SCDOT will continue to operate and maintain the existing bridge through a transition period for up to 90 calendar days after traffic has been permanently shifted to the new bridge. Once traffic is permanently shifted to the new bridge, the contractor shall be responsible for salvage, demolition and removal of the existing bridge. The contractor shall remove the swing span and associated foundation to clear the navigational channel during the transition period described herein. For each calendar day after the transition period that SCDOT continues to operate the swing span, SCDOT will assess liquidated damages of \$800.00 per calendar day. This 90 calendar day transition period is contingent upon USCG approval and may

EXHIBIT 5 – SPECIAL PROVISIONS AND CONTRACT REQUIREMENTS

be reduced by their requirements. After the transition period, the remaining portions of the existing bridge shall become the responsibility of the contractor.

From NTP to the time that the swing span is no longer operational, provide and maintain access and parking for bridge tenders. Vehicular access shall be traversable by passenger cars (HDM Design Vehicle Type P), and at a minimum, bridge tender parking shall accommodate two (2) passenger cars (HDM Design Vehicle Type P). Provide safe pedestrian access from the parking area to the existing catwalk.

For SCDOT owned utilities and for utilities that service SCDOT facilities within the project limits including the existing bridge, the Contractor shall comply with SCDOT Standard Specification 107.22. For SCDOT owned utilities, from NTP to the time that these utilities are abandoned, the Contractor shall be responsible for maintaining utility service. When SCDOT utility service is no longer needed, the Contractor shall be responsible for abandoning and removing the SCDOT owned utilities.

(7) SECTION 106: SOURCE OF PRODUCTION OF IRON AND STEEL PRODUCTS:

Delete Paragraph 1 of Subsection 106.11 of the Standard Specifications and replace it with the following:

“On this project where steel or iron materials are used, all manufacturing processes for iron and steel material, including tie wire for reinforcing steel, must occur in the United States in accordance with 23 CFR Section 635.410(b)(1)(ii). This requirement includes the application of coating for these materials. Coating includes all processes that protect or enhance the value of the material to which the coating is applied.”

(8) SECTION 106: SOURCE OF SUPPLY AND QUALITY OF MATERIALS:

Delete Paragraph 3 of Subsection 106.1 of the Standard Specifications and replace it with the following:

“When materials, components, or elements that are not specifically covered in the Standard Specifications, Supplemental Specifications, Supplemental Technical Specifications, or Project Special Provisions are proposed to be incorporated into the work, submit to the RCE a specification covering the proposed material, component, or element for review and acceptance prior to incorporating it into the work. Ensure that such materials, components, or elements meet the requirements of the AASHTO specifications that were effective as of the date of the Final RFP. If the materials, components, or elements are not covered in the AASHTO specifications, ensure that they meet the requirements of the ASTM specifications that were effective as of the date of the Final RFP. Submission of a specification for a material, component, or element not covered in the Standard Specifications, Supplemental Specifications, Supplemental Technical Specifications, or Project Special Provisions does not guarantee approval for use on the Project.”

(9) SECTION 106: PLANT/FABRICATOR INSPECTION:

Subsection 106.4, **Plant Inspection**, of the Standard Specifications shall be amended with the following:

Change the subsection title to **Plant/Fabricator Inspection** and add the following sentence after the first sentence:

“Provide 14 calendar days written notice to the Materials and Research Engineer prior to beginning fabrication work for Department projects.”

(10) SECTION 106: QUALIFIED PRODUCT LISTINGS:

All references to “Approval Sheet” or “Approval Policy” are to be replaced with “Qualified Products Listings (QPL)” and “Qualified Products Policies (QPP)” respectively. This change includes all

EXHIBIT 5 – SPECIAL PROVISIONS AND CONTRACT REQUIREMENTS

references in the SCDOT Standard Drawings, SCDOT Standard Specifications, SCDOT Supplemental Specifications, SCDOT Special Provisions, SCDOT Supplemental Technical Specifications, SCDOT Internet and Intranet websites, and all other documents produced by SCDOT.

(11) SECTION 106: SOUTH CAROLINA MINING ACT:

The South Carolina Mining Act Supplemental Specification dated March 20, 2003 is hereby modified as follows:

Paragraph 9 is hereby deleted and replaced with the following:

The deputy secretary for engineering, or his duly appointed representative, will make a final inspection of the reclaimed area and keep a permanent record of his approval thereof. A map or sketch providing the location and approximate acreage of each pit used on the project will be provided to the resident construction engineer for inclusion in the final plans.

The last paragraph is hereby deleted and replaced with the following:

The contractor shall comply with the provisions of the plan that are applicable to the project as determined by the engineer. Seeding or other work necessary to comply with the plan on pits furnished by the contractor shall be at the expense of the contractor. Seeding shall be in accordance with SC-M-810 (latest version) which can be found at http://www.scdot.org/doing/road_SupTechSpec.aspx.

(12) SECTION 107: PROJECT BULLETIN BOARDS:

In accordance with the Required Contract Provisions Federal-Aid Construction Contracts Section II, Item 3, Part d, add the following:

Single Location Projects – On projects in which work is performed at a single location (such as bridge replacement projects, two-lane to five-lane widening projects, etc.), mount the project bulletin board in a permanent location within the project limits so that it is visible and accessible at all times.

Multiple Location Projects – On projects in which work is being performed or has the capability of being performed at multiple locations (such as resurfacing projects, pavement marking projects, etc.), display a portable bulletin board with at least one of the prime contractor's work crews. If the prime contractor is not performing work, display the portable bulletin board with at least one of the subcontractor's work crews. Display the portable bulletin board in a location and a manner that is acceptable to the RCE. Notify the RCE and all subcontractors as to the location of the portable bulletin board. On resurfacing projects, mount an additional project bulletin board in a permanent location at the asphalt plant supplying asphalt mix to the project so that it is visible and accessible at all times.

(13) SECTION 107: FAIR LABOR STANDARDS ACT OF 1938, AS AMENDED:

Attention is directed to this Federal Legislation, which has been enacted into law. The contractor will be responsible for carrying out all of the provisions of this legislation, which may affect this contract.

(14) SECTION 107: CARGO PREFERENCE ACT REQUIREMENTS:

- A. Use of United States-flag vessels – General Provisions:
"(1) Pursuant to Pub. L. 664 (43 U.S.C. 1241(b)) at least 50 percent of any equipment, materials or commodities procured, contracted for or otherwise obtained with funds granted, guaranteed, loaned, or advanced by the U.S. Government under this agreement, and which may be transported by ocean vessel, shall be transported on privately owned United States-flag commercial vessels, if available.

EXHIBIT 5 – SPECIAL PROVISIONS AND CONTRACT REQUIREMENTS

"(2) Within 20 days following the date of loading for shipments originating within the United States or within 30 working days following the date of loading for shipments originating outside the United States, a legible copy of a rated, 'on-board' commercial ocean bill-of-lading in English for each shipment of cargo described in paragraph (A)(1) of this section shall be furnished to both the Contracting Officer (through the prime contractor in the case of subcontractor bills-of-lading) and to the Division of National Cargo, Office of Market Development, Maritime Administration, Washington, DC 20590."

B. Use of United States-flag vessels - The contractor agrees:

"(1) To utilize privately owned United States-flag commercial vessels to ship at least 50 percent of the gross tonnage (computed separately for dry bulk carriers, dry cargo liners, and tankers) involved, whenever shipping any equipment, material, or commodities pursuant to this contract, to the extent such vessels are available at fair and reasonable rates for United States-flag commercial vessels.

"(2) To furnish within 20 days following the date of loading for shipments originating within the United States or within 30 working days following the date of loading for shipments originating outside the United States, a legible copy of a rated, 'on-board' commercial ocean bill-of-lading in English for each shipment of cargo described in paragraph (B)(1) of this section to both the Contracting Officer (through the prime contractor in the case of subcontractor bills-of-lading) and to the Division of National Cargo, Office of Market Development, Maritime Administration, Washington, DC 20590.

"(3) To insert the substance of the provisions of this clause in all subcontracts issued pursuant to this contract."

(15) SECTION 107: CONTRACT PROVISION TO REQUIRE CERTIFICATION AND COMPLIANCE CONCERNING ILLEGAL ALIENS:

By submission of this bid, the bidder as the prime contractor does hereby agree:

- A. to certify its compliance with the requirements of Chapter 14 of Title 8 of the S.C. Code of Laws regarding Unauthorized Aliens and Public Employment;
- B. to provide SCDOT with any documents required to establish such compliance upon request; and
- C. to register and participate and require agreement from subcontractors and sub-subcontractors to register and participate in the federal work authorization program to verify the employment authorization of all new employees, or to employ only workers who supply the documents required pursuant to S.C. Code 8-14-20(B)(2).

(16) SECTION 107: IRAN DIVESTMENT ACT:

By submission of this bid/proposal, the bidder/proposer as the prime contractor/consultant/vendor does hereby certify his compliance to the following:

EXHIBIT 5 – SPECIAL PROVISIONS AND CONTRACT REQUIREMENTS

- A. CERTIFICATION: (a) The Iran Divestment Act List is a list published pursuant to Section 11-57-310 that identifies persons engaged in investment activities in Iran. Currently, the list is available at the following URL: <http://procurement.sc.gov/PS/PS-iran-divestment.phtm>. Section 11-57-310 requires the government to provide a person ninety days (90) written notice before he is included on the list. The following representation, which is required by Section 11-57-330(A), is a material inducement for the SCDOT to award a contract to you. (b) By signing your Offer, you certify that, as of the date you sign, you are not on the then-current version of the Iran Divestment Act List. (c) You must notify the SCDOT immediately if, at any time before posting of a final statement of award. You are added to the Iran Divestment Act List.
- B. ONGOING OBLIGATIONS: (a) You must notify SCDOT immediately if, at any time during the contract term, you are added to the Iran Divestment Act List. (b) Consistent with Section 11-57-330(B), you shall not contract with any person to perform a part of the Work, if, at the time you enter into the subcontract, that person is on the then-current version of the Iran Divestment Act List.
- C. OPTION TO RENEW RESTRICTION: Contractor acknowledges that, unless excused by Section 11-57-320, if the contractor is on the then-current Iran Divestment Act List as of the date of any contract renewal, the renewal will be void ab initio.

(17) SECTION 107: APPLICATION OF DAVIS-BACON AND RELATED ACTS TO INDEPENDENT TRUCK DRIVERS AND MISCELLANEOUS CONSTRUCTION ACTIVITIES:

June 13, 1990

- A. The Davis-Bacon and Related Acts apply when:
 - 1. A Contractor or Subcontractor hires a trucking firm or fleet of trucks to haul materials from a plant, pit, or quarry, which has been established specifically to serve (or nearly so) a particular project or projects covered by Davis-Bacon and Related Acts.
 - 2. A Contractor or Subcontractor hires a trucking firm or fleet of trucks to haul material from a non-commercial stockpile or non-commercial storage site outside the limits of the project to the project site.
 - 3. A Contractor or Subcontractor hires a trucking firm or fleet of trucks to haul excavated materials away from a Davis-Bacon covered project.
 - 4. A contractor or Subcontractor rents or leases equipment with an operator to perform work as called for under a Davis-Bacon construction contract.
 - 5. A common carrier is used for the transportation of materials from an exclusive material supply facility to fulfill the specific need of a construction contract.

The fleet owner is not considered a Subcontractor with regard to the 70% subcontracting limitations and would not have to be approved as a Subcontractor. However, payrolls must be submitted by truck fleet owner covering the truck drivers, and all requirements such as predetermined wages, overtime, etc., are applicable. Legitimate owner-operators (truck owner driving his own truck) must appear on the payroll by name and notation "truck Owner Operator" with no hours, etc. shown.

- B. The Davis-Bacon and Related Acts do not apply when:
 - 1. A Contractor or Subcontractor hires a trucking firm or fleet of trucks to haul materials from a commercial plant, pit, or quarry which had previously been established for commercial use and regularly sell materials to the general public.
 - 2. A Contractor or Subcontractor hires a trucking firm or fleet of trucks to haul materials from an established commercial plant, pit, or quarry to a stockpile outside the limits of the project.
 - 3. Bona fide owner-operators of trucks, who are independent contractors, use their own equipment to haul materials to or from or on a Davis-Bacon covered project. (One man-One truck)

The fleet owner is not considered a Subcontractor with regard to the 70% subcontracting limitation and would not have to be approved as a Subcontractor.

(18) SECTION 107: REQUIREMENTS FOR FEDERAL AID CONTRACTS WHICH AFFECT SUBCONTRACTORS, DBE HAULERS, MATERIAL SUPPLIERS AND VENDORS:

March 1, 2010

- A. The contractor's attention is directed to the requirements of Section I.2 in Form FHWA 1273 that is included in your contract documents as the Supplemental Specification "Required Contract Provisions Federal-Aid Construction Contracts". Section I.2 requires that "the contractor shall insert in each subcontract all of the stipulations contained in the Required Contract Provisions". This requirement also applies to lower tier subcontractors or purchase orders. These provisions must be physically included in your subcontracts. A reference to the applicable specification will not suffice.
- B. The contractor's attention is directed to the requirements of the Supplemental Specification "Standard Federal Equal Employment Opportunity Construction Contract Specifications". Section 2 requires that the provisions of this specification must be physically included in each subcontract with a value of \$10,000 or greater.
- C. The contractor's attention is directed to the requirements of the Equal Employment Opportunity Performance certifications in the Proposal Form Certifications and Signatures section of the contract. Section 1 concerning Equal Employment Opportunity must be physically included in each subcontract.
- D. Prior to the issuance of formal approval, all DBE subcontracts must include a signed copy of the subcontract agreement between the Prime Contractor and the DBE Subcontractor.
- E. Prior to the issuance of formal approval, of any DBE haulers, the contractor must submit a signed copy of the hauling agreement.
- F. The contractor's attention is further directed that sections 1, 2, 3, 8, 9, and 11 of Form FHWA 1273, or Sections 1, 3, 8 and 10 of Form 1316 (for Appalachian contracts only) must be physically included in each purchase agreement with a value of \$10,000 or greater with a vendor or supplier, and in open-end contracts where individual purchases are less than \$10,000 but where the total purchases accumulate to \$100,000 or more per year.

(19) SECTION 107: DISADVANTAGED BUSINESS ENTERPRISES (DBE) GOALS AND REQUIREMENTS:

A. GENERAL

For Design Build Projects, PROPOSER shall comply with the Disadvantaged Business Enterprises (DBE) Supplemental Specification, dated August 3, 2015, except as specifically modified pursuant to this special provision. This special provision modifies the timing and steps for which the PROPOSER is to obtain DBE commitments for a design build project. The DBE goal on this project is seven percent of the contract price.

B. DBE PROGRAM RELATED CERTIFICATIONS

By submitting a proposal and by entering into any contract on the basis of that proposal, the PROPOSER certifies to each of the following DBE Program-related conditions and assurances:

- 1. That the PROPOSER agrees to comply with the project construction and administration obligations of the USDOT DBE Program, 49 CFR Part 26 as amended, and the DBE Supplemental Specifications setting forth the SCDOT's DBE Program requirements.
- 2. PROPOSER shall comply fully with the DBE Program requirements in the execution and performance of the Contract. PROPOSER acknowledges that failure to comply may result in any one or more of the sanctions listed in the SCDOT's DBE Supplemental Specification.
- 3. To ensure that DBE firms have been given full and fair opportunity to participate in the performance of the contract, PROPOSER certifies that all reasonable steps were, and will be, taken to ensure that DBE firms had, and will have, an opportunity to compete for and perform work on the contract. The PROPOSER further certifies that the PROPOSER shall not discriminate on the basis of race, color, age, national origin, or sex in the performance of the contract or in the award of any subcontract. Any agreement between a PROPOSER and a DBE whereby the DBE promises not to provide quotations for performance of work to other PROPOSERS is prohibited.

EXHIBIT 5 – SPECIAL PROVISIONS AND CONTRACT REQUIREMENTS

4. PROPOSER shall make good faith efforts to obtain DBE participation in the proposed contract at or above the goal. The PROPOSER, by submitting its proposal, certifies the DBE participation information that will be submitted within the required time as specified herein is true, correct, and complete, and that the information to be provided includes the names of all DBE firms that will participate in the contract, the specific item(s) that each listed DBE firm will perform, and the dollar amounts of the participation of each listed DBE.
5. By submitting its proposal, the PROPOSER certifies that good faith efforts will be made on work that it proposes to subcontract; and that it will seek out and consider DBE firms as potential subcontractors and sub-consultants. The PROPOSER shall, as a continuing obligation, contact DBE firms to solicit their interest, capability, and prices in sufficient time to allow them to respond effectively, and shall retain on file proper documentation to substantiate its good faith efforts.
6. PROPOSER shall comply fully with all contractual and legal requirements of the USDOT DBE Program and SCDOT DBE Program, and shall cause each DBE firm participating in the Contract to fully perform the designated work items with the DBE firm's own forces and equipment under the DBE firm's direct supervision, control, and management. Where a contract exists and where the PROPOSER, DBE firm, or any other firm retained by the PROPOSER has failed to comply with federal or SCDOT DBE Program requirements, SCDOT has the authority and discretion to determine the extent to which the DBE contract regulations have not been met, and will assess against the PROPOSER any remedies available at law or provided in the contract.
7. If a bond surety assumes the completion of work, if for any reason the SCDOT has terminated the PROPOSER, the surety shall be obligated to meet the same DBE contract terms and requirements as were required of the original PROPOSER in accordance with the requirements of this contract.

C. DBE PROGRAM COMPLIANCE PROCEDURES

1. DBE Utilization Plan
 - a. Within thirty (30) calendar days from the effective date of the Agreement, the PROPOSER shall submit to the SCDOT a DBE Utilization Plan for review and approval. This plan shall include the following information:
 - 1) The various work elements the PROPOSER anticipates subcontracting to DBE firms in order to meet the established contract goal;
 - 2) The expected dollar amount and contract percentages of each work element to be applied towards meeting the contract goal; and
 - 3) Anticipated timeframes for which PROPOSER expects DBE subcontracts to be executed for each of the work elements identified.
 - b. The SCDOT will not accept or review any design submittals from the PROPOSER nor make any progress payments until the DBE Utilization Plan is approved by SCDOT. However, failure to promptly submit the DBE Utilization Plan will not delay the SCDOT's issuance of the Notice to Proceed thereby commencing Contract Time.
 - c. As the Project proceeds through the design phase, the PROPOSER may submit revisions to the approved DBE Utilization Plan, if necessary, for the SCDOT's consideration and approval. Reasons for the revisions shall be documented by the PROPOSER and included in the revision request.
 - d. In the DBE Utilization Plan submittal, CONTRACTOR shall designate and make known to the SCDOT a DBE liaison officer who is assigned the responsibility of administering and promoting an active and inclusive DBE program as required by 49 CFR Part 26, the SCDOT's DBE Supplemental Specifications, and this Special Provision.
 - e. After approval of the DBE Utilization Plan, PROPOSER may begin submitting DBE Committal Sheets for review and acceptance at the monthly Progress Meetings.
2. Establishing DBE Committals

EXHIBIT 5 – SPECIAL PROVISIONS AND CONTRACT REQUIREMENTS

- a. The PROPOSER shall aggressively implement the approved DBE Utilization Plan by submitting DBE Committal Sheets listing specific DBE firms to carry out the identified work elements. **The use of DBE firms and the information to be provided on the DBE Committal Sheet shall be as instructed in Part A of the SCDOT's DBE Supplemental Specification.**
 - b. The PROPOSER shall obtain the SCDOT's approval of all subcontracts as set forth in the SCDOT DBE Supplemental Specification.
 - c. PROPOSER shall not unilaterally terminate, substitute for, or replace any DBE firm listed on the Committal Sheet in whole or in part with another DBE, any non-DBE firm, or with the PROPOSER's own forces without the prior written consent of SCDOT as set forth in the SCDOT DBE Supplemental Specification.
 - d. The PROPOSER's Final DBE Committal Sheet, signed quotes, and all DBE executed subcontracts are to be submitted to the SCDOT within 90 calendar days from the "Notice To Proceed." If the PROPOSER fails to meet the 90 calendar day deadline, SCDOT shall withhold progress payments until the Final DBE Committal Sheet is submitted. Construction shall not begin until all DBE Committal Sheets are received by SCDOT.
 - e. If the Final DBE Committal Sheet falls short of the DBE contract goal, the PROPOSER shall submit good faith efforts documentation in accordance with Part A of the DBE Supplemental Specification. This information is due within three (3) business days following the due date of the Final DBE Committal Sheet. If upon review of the Final DBE Committal Sheet, good faith efforts documentation and, if necessary, the findings of the Reconsideration Panel, the PROPOSER fails to meet the contract DBE goal or demonstrate good faith, the SCDOT will withholding monthly progress payments until compliance with DBE contract goal or PROPOSERs good faith efforts have been accepted by SCDOT.
3. Progress Review Meetings / Monthly Updates
- a. Implementation of the PROPOSER's DBE Utilization Plan shall be a discussion point during each progress review meeting (as required in the Agreement) until such time as the SCDOT deems it a closed issue. The PROPOSER's DBE liaison officer shall attend all progress review meetings until such time the issue is closed. At each progress review meeting, the DBE liaison officer shall provide a summary of the PROPOSER's progress towards implementing the DBE Utilization Plan as well as provide an updated DBE Committal sheet.
 - b. The PROPOSER shall provide the SCDOT monthly updates of its progress in accomplishing the DBE Utilization Plan. Monthly updates must include a copy of the latest committal sheet, signed quotes and copies of executed DBE subcontracts. The SCDOT's approval date of the DBE Utilization Plan will establish the date for which monthly updates are required of the PROPOSER.
 - c. The SCDOT, at its discretion, may withhold progress payments if the PROPOSER fails to submit monthly updates or any other submittal requirement on time or if the SCDOT believes the efforts of the PROPOSER in implementing the DBE Utilization Plan are insufficient.
4. PROPOSER's Obligation Post DBE Committal
- a. Once a firm is listed on the DBE Committal sheet, the PROPOSER shall administer the subcontract with the firm in accordance with the instructions provided in Part B of the SCDOT DBE Supplemental Specification.
 - b. It is the PROPOSER's responsibility to comply with all elements of the SCDOT's DBE Program and to continuously pursue DBE participation as the project progresses. If the PROPOSER's Final DBE Committal Sheet and good faith efforts fall short of meeting the project goal and/or payments to committed DBE firms were less than the committed amounts, SCDOT may impose one of the sanction set forth under Part B of the SCDOT DBE Supplemental Specifications.

EXHIBIT 5 – SPECIAL PROVISIONS AND CONTRACT REQUIREMENTS

- c. PROPOSER, for itself, for its design build team, and for its subcontractors and suppliers, whether certified DBE firm or not, commits to complying fully with all federal and state DBE provisions and agrees to assume these contractual obligations and to bind the design build team contractually to the same at the PROPOSER's expense.

(20) SECTION 107: LATE DISCOVERY OF ARCHAEOLOGICAL/HISTORICAL REMAINS ON FEDERAL AID PROJECTS AND APPROVAL OF DESIGNATED BORROW PITS:

August 7, 1991

A. LATE DISCOVERY OF ARCHAEOLOGICAL/HISTORICAL REMAINS ON FEDERAL AID PROJECTS

1. Responsibilities:

The Contractor and subcontractors must notify their workers to watch for the presence of any prehistoric or historic remains, including but not limited to arrowheads, pottery, ceramics, flakes, bones, graves, gravestones, or brick concentrations. If any such cultural remains are encountered, the Resident Construction Engineer shall be immediately notified and all work in the vicinity of the discovered materials or site shall cease until the Department's Staff Archaeologist or the State Highway Engineer directs otherwise.

2. Applicability:

This provision covers all areas of ground disturbance resulting from this federal - aid contract, including but not limited to road construction, Department designated borrow pits, Contractor furnished borrow pits, and/or staging areas.

3. Cost Reimbursement and Time Delays:

Any extra work required by A(1) above within the project right of way or on Department designated borrow pits (see below) will be paid for in accordance with Subsection 104.05 of the Standard Specifications. Extra contract time may be provided under Subsection 108.06 of the Standard Specifications for archaeological work within the project right of way or on designated borrow pits.

NOTE: On Contractor furnished borrow pits the contractor is not entitled to any additional time or money for delay on impact resulting from A(1) above or for extra work required by A(1) above. Therefore, contractors may wish to retain professional archaeological services to better ensure that borrow pit areas are cleared of archaeological/historical remains prior to use on Federal aid projects.

B. APPROVAL OF DESIGNATED BORROW PITS ON FEDERAL AID PROJECTS (PLANT SITES WHICH QUALIFY AS COMMERCIAL ARE NOT INCLUDED)

In instances where the Department specifically designates the location of borrow pits on project plans or in contract specifications for use on a Federal aid project, an archaeological survey will be performed by Department archaeologists prior to award of contract.

This provision also applies to designated disposal sites, staging areas, haul roads, and job site field offices.

(21) SECTION 107: SPECIFIC EQUAL EMPLOYMENT OPPORTUNITY RESPONSIBILITIES TRAINING SPECIAL PROVISIONS:

August 20, 1975

Revised April 1, 2004

This Training Special Provision supersedes Subparagraph 7b of the Special Provision entitled "Specific Equal Employment Opportunity Responsibilities", (Attachment 1), and is in implementation of 23 U.S.C. 140(a).

EXHIBIT 5 – SPECIAL PROVISIONS AND CONTRACT REQUIREMENTS

As part of the contractor's equal employment opportunity affirmative action program, training shall be provided as follows:

The contractor shall provide on-the-job training aimed at developing full journeymen in the type of trade or job classification involved.

THE NUMBER OF TRAINEES TO BE TRAINED UNDER THE SPECIAL PROVISION WILL BE.

Road – 2 (at 520 hours each).
Bridge – 3 (at 1040 hours each).

In the event that a Contractor subcontracts a portion of the contract work, he shall determine how many, if any, of the trainees are to be trained by the subcontractor, provided however, that the Contractor shall retain the primary responsibility for meeting the training requirements imposed by this Special Provision. The Contractor shall also insure that this training Special Provision is made applicable to such subcontract. Where feasible, 25 percent of apprentices or trainees in each occupation shall be in their first year of apprenticeship or training.

The number of trainees shall be distributed among the work classifications on the basis of the Contractor's needs and the availability of journeymen in the various classifications within a reasonable area of recruitment. Prior to commencing construction, the Contractor shall submit to the State Highway Agency for approval the number of trainees to be trained in each selected classification and training program to be used. Furthermore, the Contractor shall specify the starting time for training in each of the classifications. The Contractor will be credited for each trainee employed by him on the contract work who is currently enrolled or becomes enrolled in an approved program.

Training and upgrading of minorities and women toward journeyman status is a primary objective of this Training Special Provision. Accordingly, the Contractor shall make every effort to enroll minority trainees and women (e.g., by conducting systematic and direct recruitment through public and private sources likely to yield minority and women (trainees)) to the extent that such persons are available within a reasonable area of recruitment. The contractor will be responsible for demonstrating the steps that he has taken in pursuance thereof, prior to a determination as to whether the Contractor is in compliance with this Training Special Provision. This training commitment is not intended, and shall not be used, to discriminate against any applicant for training, whether a member of a minority group or not.

No employee shall be employed as a trainee in any classification in which he has successfully completed a training course leading to journeyman status or in which he has been employed as a journeyman. The Contractor should satisfy this requirement by including appropriate questions in the employee application or by other suitable means. Regardless of the method used the Contractor's records should document the findings in each case.

The minimum length and type of training for each classification will be as established in the training program selected by the Contractor and approved by the State Highway Agency and the Federal Highway Administration. The State Highway Agency and the Federal Highway Administration shall approve a program if it is reasonably calculated to meet the equal employment opportunity obligations of the Contractor and to qualify the average trainee for journeyman status in the classification concerned by the end of the training period. Furthermore, apprenticeship programs registered with the U.S. Department of Labor, Bureau of Apprenticeship and Training, or with a State apprenticeship agency recognized by the Bureau and training programs approved but not necessarily sponsored by the U.S. Department of Labor, Manpower Administration, Bureau of Apprenticeship and Training shall also be considered acceptable provided it is being administered in a manner consistent with the equal employment obligations of Federal Aid highway construction contracts. Approval or acceptance of a training program shall be obtained from the State prior to commencing work on the classification covered by the program. It is the intention of these provisions that training is to be provided in the construction crafts rather than clerk-typists or secretarial-type

EXHIBIT 5 – SPECIAL PROVISIONS AND CONTRACT REQUIREMENTS
--

positions. Training is permissible in lower level management positions such as office engineers, estimators, timekeepers, etc., where the training is oriented toward construction applications. Training in the laborer classification may be permitted provided that significant and meaningful training is provided and approved by the division office. Some off-site training is permissible as long as the training is an integral part of an approved training program and does not comprise a significant part of the overall training.

Except as otherwise noted below, the cost for the training will be included in the contract price. There will be no reimbursement given by SCDOT for the hours of training that are provided on this project. However, a "Statement of Completed Training" will be required at the end of the project. The fact that the cost of the training must be included in the contract does not prohibit the contractor from receiving training program funds from other sources, if he so desires. Training hours may be counted if training is done off-site where the contractor does one or more of the following and the trainees are concurrently employed on a Federal Aid project: contributes to the cost of the training, provides the instruction to the trainee, or pays the trainee's wages during the off-site training period.

The training requirement will not be considered completed by the Contractor if either the failure to provide the required training, or the failure to hire the trainee as a journeyman, is caused by the Contractor and evidences a lack of good faith on the part of the Contractor in meeting the requirements of this Training Special Provision. It is normally expected that a trainee will begin his training on the project as soon as feasible after start of work the skill involved and remain on the project as long as training opportunities exist in his work classification or until he has completed his training program. It is not required that all trainees be on board for the entire length of the contract. A Contractor will have fulfilled his responsibilities under this Training Special Provision if he has provided acceptable training to the number of trainees specified. The number trained shall be determined on the basis of the total number enrolled on the contract for a significant period.

Trainees will be paid at least 60 percent of the appropriate minimum journeyman's rate specified in the contract for the first half of the training period, 75 percent for the third quarter of the training period, and 90 percent for the last quarter of the training period, unless apprentices or trainees in an approved existing program are enrolled as trainees on this project. In that case, the appropriate rates approved by the Departments of Labor or Transportation in connection with the existing program shall apply to all trainees being trained for the same classification who are covered by this Training Special Provision.

The Contractor shall furnish the trainee a copy of the program he will follow in providing the training. The Contractor shall provide each trainee with a certification showing the type and length of training satisfactorily completed.

The Contractor will provide for the maintenance of records and furnish periodic reports documenting his performance under this Training Special Provision, as required under the SCDOT approved training program.

Meeting the On-the-job Training Requirements or Making Good Faith Efforts to Meet the On-the-job Training Requirements. It is the Contractor's responsibility to meet the On-the-job Training Requirements stated in this section. Failure to meet the requirement or demonstrate good faith efforts, as determined by SCDOT, to meet the requirement may result in any one or more of the following sanctions:

EXHIBIT 5 – SPECIAL PROVISIONS AND CONTRACT REQUIREMENTS

- A. Withholding monthly progress payments;
- B. Declaring the Contractor in default pursuant to Section 108.10 of the Standard Specifications and terminating the contract;
- C. Disqualifying the Contractor from bidding pursuant to Regulation 63-306, Volume 25A, of the S. C. Code of Laws; and/or
- D. Requiring the Contractor to obtain On-the-job Training participation on future contracts to the extent the Contractor failed to meet or use good faith efforts to meet the On-the-job training contract requirement.

(22) SECTION 107: MONITORING OF CONSTR.-RELATED EARTHBORNE VIBRATIONS:

July 8, 2015

A. DESCRIPTION

The project construction will generate vibrations that will travel through the earth, which will subsequently be received or “sensed” by nearby structures and inhabitants. Specific procedures that will generate earthborne vibrations during bridge and roadway construction include (but are not limited to) the installation of piles, earthquake drains, shoring walls, general foundation construction, and vibratory compaction of unclassified or borrow excavation. To mitigate the risk of vibration-related damage to nearby structures, this specification outlines the Contractor’s responsibility for performing a program of pre-construction condition assessment and vibration monitoring during construction.

This specification is based, in part, on AASHTO R 8-96 (2004) *Standard Recommended Practice for Evaluation of Transportation-Related Earthborne Vibrations*. As discussed in AASHTO R 8-96 (2004), humans respond to a much broader range of vibration frequencies and intensities than structures. Intrusive vibration levels can annoy humans at much lower intensities than levels considered critical for structures. Thus, occupants of adjacent properties may perceive that the construction-induced vibrations may present risk to their structures. The recommended safe vibration limits are intended to mitigate the risk of structure damage, and more specifically, reduce the development of “threshold cracks” or cosmetic cracking. Such cracks may appear at lower vibration levels than the level at which architectural or minor structural damage would be expected to occur.

B. PRE-CONSTRUCTION CONDITION ASSESSMENT

The Contractor shall retain a geotechnical engineering firm to perform a pre-construction condition assessment to document the conditions of nearby buildings and other sensitive nearby structures prior to the beginning of construction. The assessment shall be performed on all properties adjacent to the project site and any other properties as directed by the Engineer. The assessment shall include any structures within 300 feet of any vibration inducing construction activity. **Include the existing bridge in the assessment.** The assessment ~~should~~ shall include video and photographic documentation of all exteriors and interiors, and installation of crack monitors on cracks that might propagate due to construction vibrations. **For the existing bridge, expect to monitor a maximum of ten cracks.** All documentation of existing structure building conditions and information concerning the type and location of crack monitors shall be presented to the Engineer in a report prior to construction.

C. CRACK MONITORING DURING CONSTRUCTION

During all construction, the Contractor shall perform periodic readings of the crack monitors that were installed during the pre-construction condition assessment. All readings shall be provided to the Engineer within 48 hours of taking the reading. Provided that the crack readings confirm that vibrations are not contributing to increasing the crack width, the crack monitors may be read once per week. More frequent readings may be directed by the Engineer during activities that are expected to have greater earthborne vibrations (e.g., pile driving). If the crack readings suggest that vibrations from the project site are contributing to crack width, then the Contractor shall immediately notify the Engineer and review those activities that are generating the earthborne vibrations. The Contractor and his or her geotechnical firm shall then submit a detailed plan for repair, perform the repair at no cost to the Department and develop and submit

for review a revised construction plan to address the vibration problems and minimize further damage and complaints.

D. VIBRATION MONITORING DURING CONSTRUCTION

1. Procedure - The Contractor shall monitor vibrations at no less than four locations at each specific site of construction activity along the perimeter of the project during all foundation and embankment construction activities. The locations shall be selected by the Contractor based on the location of the construction activities and their relative position to nearby offsite structures. Prior to construction, a plan of the monitoring locations shall be submitted to the Engineer for acceptance. The locations of the vibration monitors shall be adjusted during construction with acceptance by the Engineer. The vibration monitors shall be established at the site so that background vibrations may be determined prior to beginning foundation or embankment construction. The sensitivity range of the seismograph shall be selected so that the recording is initiated below the maximum allowable particle velocity shown in Figure 1 and extends above the highest expected intensity. Specific activities of the vibration source shall be indexed in time to allow correlation with the arrivals on the vibration
2. Project Vibration Criteria - The maximum allowable particle velocity is shown in Figure 1. If the data from the monitors indicate that vibrations are exceeding the established criteria, then the Contractor shall immediately notify the Engineer and suspend those activities which are generating the earthborne vibrations, until the Contractor and his or her geotechnical firm have developed a revised construction plan to resolve the problem. The problem shall be resolved at no additional cost to the Department.
3. Instrumentation – The vibration monitors shall consist of digital seismographs that display the particle velocities and associated frequencies plotted against the criteria for this project (i.e., Figure 1). Each seismograph shall contain geophones with response capability in three mutually perpendicular axes or components: one vertical and two horizontal (radial and transverse). The frequency response of the geophones shall be linear from at least 4 Hz to more than 200 Hz. The sensitivity shall range from less than 0.02 in/sec to more than 5.0 in/sec. The BlastMate III by InstanTel is one type of seismograph that is suitable for this project.
4. Calibration and Instrument Use - The Contractor shall field calibrate the vibration monitors before the start of each recording period. The transducer shall be positioned with the longitudinal axis toward the vibration source. Transducers must be adequately coupled with the ground. Operation of all vibration monitors shall be in accordance with the instrument manufacturer's instructions and recommendations. Vibration records shall be collected in waveform plot or strip chart plot. The peak vector sum of the particle velocity in longitudinal, transverse, and vertical planes shall be shown along with the respective dominant or principle frequencies. The highest recorded particle velocity (i.e., the vector sum of the three orthogonal directions), when indexed to a particle vibration event, shall be reported as the peak particle velocity. The recorded peak particle velocity shall be compared to criteria appropriate for the subject of concern.
5. Complaints - In the event of a complaint, the Contractor shall immediately contact the Engineer and review those construction activities that are inducing vibrations into the earth. The Contractor shall prepare a report documenting all relevant data such as the time and date presented in the complaint, a description of the construction activities during the subject time/date, data from the monitoring instruments for the subject time/date, complaint information and a description (including photographs, if possible) of the alleged damage. The Contractor and his or her geotechnical firm shall then submit a detailed plan for repair, perform the repair at no cost to the Department and develop and submit for review a revised construction plan to address the vibration problems and minimize further damage and complaints.

EXHIBIT 5 – SPECIAL PROVISIONS AND CONTRACT REQUIREMENTS

E. METHOD OF MEASUREMENT

In addition to the pre-construction condition assessment report, the Contractor shall also provide monthly reports containing the results of the crack monitors and vibration monitors during those activities that generate earthborne vibrations, including (but not limited to) ground improvement and foundation construction. The reports shall document that the Contractor is providing the work described by this specification.

F. BASIS OF PAYMENT

Payment shall be made in proportion with the percent of the project that is complete. Final payment of the remaining lump sum balance shall be made when vibration monitoring is complete as approved by the Engineer. Payments shall be made under:

Item No.	Pay Item	Pay Unit
1075001	MONITORING OF CONSTRUCTION-RELATED EARTHBORNE VIBRATIONS	LS

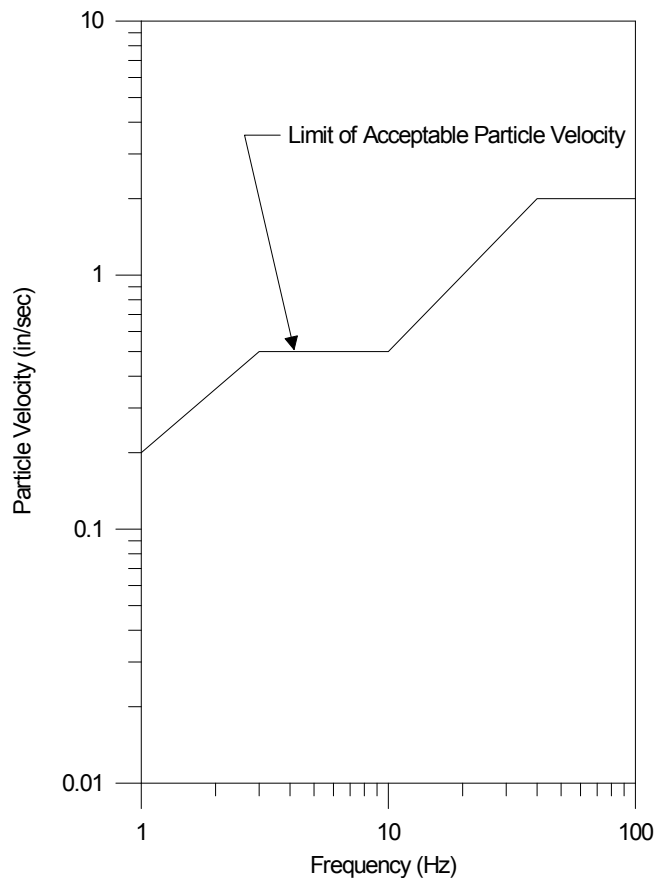

Figure 1 - Vibration Criteria (adapted from AASHTO R8-96)

(23) SECTION 107: COMMUNITY AND PUBLIC RELATIONS PLAN:

SCDOT will take the lead role on this project and be responsible for a portion of the public information efforts. Unless noted otherwise elsewhere in this RFP, the SCDOT responsibilities include:

EXHIBIT 5 – SPECIAL PROVISIONS AND CONTRACT REQUIREMENTS

- A. Developing and maintaining the project website
- B. Soliciting and administering advertisements and media announcements, as deemed necessary

The Contractor shall coordinate with the Department to promote public awareness for this project. The amount of public involvement required for this project is directly based on the Contractor's Transportation Management Plan and construction details. The Design- Build Team's responsibilities shall include:

- A. Providing details surrounding the impacts to the public
- B. Providing advance notice to the Department of upcoming project impacts
- C. Assisting the Department in the development of the target audience list
- D. Attending and/or speaking at public meetings
- E. Hand delivery of time sensitive informational materials
- F. Preparing advertisements and media announcements
- G. Preparing and forwarding direct mailers, flyers, and other promotional materials as necessary
- H. If required, organizing public meetings, including venue selection, reservation and fee

The Contractor shall hold an initial project coordination meeting with SCDOT at least one month prior to start of construction to discuss project impacts to the public. This information will be used by the Contractor to create a Public Information Plan.

The Contractor shall inform the Department at least twenty-one (21) calendar days in advance of any construction activity that will have significant impact on the public, including, but not limited to, the start of construction, major traffic shifts, road closures, ramp closures, detours, night work and project completion.

The Contractor will develop, with the assistance of SCDOT, the specific list of target audiences for this project. The following groups are identified as typical target audiences to receive informational materials:

- A. State Senator(s) and Representative(s)
- B. Chairman of the County Council
- C. County Administrator/Manager
- D. County Planner
- E. City Mayor (as appropriate)
- F. City Manager (as appropriate)
- G. Transportation services
- H. Emergency services
- I. Neighborhood groups and private homes
- J. Industry and businesses
- K. Chamber(s) of Commerce
- L. Individual schools effected by the project
- M. Public School District(s) and Transportation Office(s)
- N. Post Office
- O. Any other organization as deemed necessary by the Department

The minimum public information requirements solely associated with the Transportation Management Plans shall include, but not be limited to the following:

Public Meetings - If Beginning of Construction meeting for area businesses and residents is held, attending and I or speaking at this event.

Distribution of Informational Materials - For beginning of construction and for all road closures with detour routes, the Contractor shall be responsible for delivering time sensitive informational material provided by the SCDOT directly to portions of the target audience. If the Contractor informs the Department of the aforementioned activities less than twenty-one (21) calendar days in advance, the Contractor shall hand deliver the informational materials to the impacted target audiences.

EXHIBIT 5 – SPECIAL PROVISIONS AND CONTRACT REQUIREMENTS

The Department will be responsible for establishing, creating, maintaining and updating the project website for this project. However, throughout the project duration, the Contractor shall coordinate with the RCE to ensure the accuracy of the aforementioned project website. At a minimum, the Contractor shall designate a contact for public information inquiries and coordination. Throughout construction, at a minimum, this contact shall provide bi-weekly updates to the RCE, including, but not limited to, traffic control phasing, graphic illustrations, project pictures, etc.

The Contractor shall include in their Total Cost to Complete, all costs associated with their involvement in the Community and Public Relations Plan.

(24) SECTION 108: PARTNERING:

A. COVENANT OF GOOD FAITH AND FAIR DEALING

This Contract imposes an obligation of good faith and fair dealing in its performance and enforcement.

The CONTRACTOR and Department, with a positive commitment to honesty and integrity, agree to the following mutual duties:

1. Each will function within the laws and statutes applicable to their duties and responsibilities.
2. Each will avoid hindering the other's performance.
3. Each will proceed to fulfill its obligations diligently.
4. Each will cooperate in the common endeavor of the Contract.

B. PARTNERING

The Department encourages the foundation of cohesive partnering with the CONTRACTOR and its principle subcontractors and suppliers. This partnering is not a legal partnership as defined by South Carolina law. Partnering will be structured to draw on the strengths of each organization to identify and achieve reciprocal goals. The objectives are effective and efficient contract performance and completion within budget, on schedule, and in accordance with the Contract.

The establishment of a partnering charter will not change the legal relationship of the parties to the contract nor relieve either party from any of the terms of the Contract. Any cost associated with effectuating partnering will be agreed to by the Department and the CONTRACTOR and will be shared equally between them.

(25) SECTION 109: FUEL ADJUSTMENT INDEXES:

No fuel adjustment will be made on this Project.

(26) SECTION 109: REFERENCES TO UNIT PRICING:

Any references in the contract documents to unit price, measurement, and payment, are typical references for design-bid-build contracts and are not applicable to the extent they effect payment on Design-Build contracts. The Design-Build contractor's schedule of values shall provide sufficient detail to compare work progress to the contractor's schedule and determine appropriate periodic payments.

(27) SECTION 202: SALVAGE OF EXISTING BRIDGE COMPONENTS:

During salvage, demolition, and removal of the existing bridge control building, the Contractor shall provide access to the control building for the purpose of salvaging equipment by SCDOT. **Once SCDOT's salvaging of equipment is complete, the swing span will cease to operate.** The Contractor shall provide an 8 hour window of time for this access. The Contractor shall provide one advance notification to the RCE two weeks prior to the access window and shall provide a second advance notification two business days prior to the access window.

EXHIBIT 5 – SPECIAL PROVISIONS AND CONTRACT REQUIREMENTS

The contractor shall begin salvage, demolition, and removal of the existing swing-span, no later than, one business day after the permanent shift of traffic to the new bridge. The Contractor shall provide to SCDOT the DC motor, DC drive, pivot bearing assembly, and gear box (hereinafter “components”) from the existing swing-span. The Contractor shall remove, lift, and load the components, and SCDOT will transport the components away from the project. The Contractor shall provide a minimum of two carpenters and all cribbing and crating materials, and after cribbing and crating, the Contractor shall load the components onto the transport vehicle. The Contractor shall provide one advance notification to the RCE two weeks prior to the removal of these components and shall provide a second advance notification two business days prior to the removal.

(28) SECTION 202: REMOVAL OF EXISTING GUARDRAIL:

Section 202.4.4.3 applies on this project.

(29) SECTION 202: RECLAIMING EXISTING ROADWAY:

A. DESCRIPTION

This work consists of the restoration of paved areas. These areas are typically shown as hatched areas on the plans when outside the construction limits.

B. MATERIALS

None

C. CONSTRUCTION REQUIREMENTS

1. Asphalt Pavement with Earth Base: Remove and dispose of areas of pavement shown as hatched areas on the plans. Grade the area to properly drain. Seed the area in accordance with Section 810.
2. Asphalt Pavement with Stone Base: Remove and dispose of areas of pavement and base shown as hatched areas on the plans. Grade the area to properly drain. Seed the area in accordance with Section 810.
3. Earth roadway or Bituminous Surfacing with Earth Base: Scarify existing areas of roadway. Grade the area to properly drain. Seed the area in accordance with Section 810.
4. Bituminous Surfacing with Stone Base: Remove and dispose of areas of pavement and base shown as hatched areas on the plans. Grade the area to properly drain. Seed the area in accordance with Section 810.

Suitable materials may be used for embankment construction on the project. In the event that removed materials are used for embankment construction a corresponding deduction in Unclassified Excavation will be made by the Resident Construction Engineer.

D. MEASUREMENT

Removed asphalt pavement greater than 2 inches in depth will be measured by the square yard. Removed bituminous surfacing with stone base will be measured by the cubic yard. Removed stone base will be measured by the cubic yard. Scarified areas will not be measured for payment.

E. PAYMENT

Removed asphalt pavement which is greater than 2 inches in depth will be paid at the unit price bid for Removal and Disposal of Existing Asphalt Pavement. Removed bituminous surfacing with stone base will be paid for at the unit price bid for Unclassified Excavation. Removed stone base will be paid for at the unit bid price for Unclassified Excavation. No payment will be made for scarifying earth roadway or bituminous surfacing with earth base. No separate or additional payment will be made for grading necessary to obtain proper drainage.

(30) SECTION 203: BORROW EXCAVATION:

Section 203.2.1.8 of the Standard Specifications is amended by adding the following:

EXHIBIT 5 – SPECIAL PROVISIONS AND CONTRACT REQUIREMENTS

Ensure that all borrow material placed on embankments meet or exceed the requirements for total and effective internal friction angle, cohesion, and total moist unit weight as specified by the geotechnical design engineer of record. These requirements shall be determined by the following tests:

- A. Internal friction angle determined from either direct shear (AASHTO T236) or triaxial (AASHTO T297) testing on remolded specimens performed by the Contractor.
- B. Cohesion determined by triaxial (AASHTO T297) testing on remolded specimens performed by the Contractor.
- C. Total moist unit weight determined by standard proctor test (AASHTO T99) on remolded specimens performed by the Contractor.

Remold all samples to 95 percent of the maximum dry density as determined by the Standard Proctor test (AASHTO T99) and test at normal/consolidation stresses specified by the geotechnical design engineer of record. Conduct shear strength and soil classification testing (AASHTO M145) at the initial selection of the borrow pit, any subsequent changes in borrow pits, and for every 50,000 cubic yards of materials placed. This testing is in addition to the normal embankment and borrow sampling and testing requirements for classification and compaction in accordance with Section 203 and 205 of the SCDOT Standard Specifications for Highway Construction that are used for daily acceptance.

Perform additional shear strength testing and/or soil classification testing at no additional cost to the Department when the Department deems that the materials being placed appear to be different from those originally tested. Submit all test results to the RCE for approval prior to use in embankment construction. The RCE will also submit copies of the test reports to the Quality Assurance Engineer at the Office of Materials and Research. Use only qualified laboratories that are appropriately accredited by AASHTO to perform the test procedures required by this specification.

Do not use material derived from Unclassified Excavation to construct embankments unless that material meets the requirements for Borrow Material as stated above.

(31) SECTION 203: BORROW EXCAVATION (FOR SHOULDERS):

This work shall consist of satisfactory placement of all materials necessary to bring the shoulder grade to within 2 inches of the final pavement edge grade. The Contractor shall furnish all earth material necessary to eliminate any edge of final pavement to shoulder gradient differential that exceeds 2 inches. The quantities shown on the plans are the Engineering estimate of the number of units that will be necessary for this project, actual field measurements may cause these quantities to vary.

Selected materials shall be used for this operation. The selected material shall consist of a friable material such as topsoil, etc., containing grass roots and having the properties of being comparatively porous, capable of growing grass and of a stable nature in that when compacted it will resist erosion and be capable of supporting vehicles when relatively wet. When the area where material is to be placed, is greater than 4 feet in width, it shall be scarified and/or disked to a minimum depth of 3 inches prior to placing any material. Scarifying or disked is not required for areas less than 4 feet in width. Borrow shall be mixed with the existing scarified and/or disked shoulder material in such a manner as to provide a seed bed in accord with Section 810.15 of the Standard Specifications. The Contractor has the option of placing the borrow material (a) Prior to placing final surface course or (b) Following the placing of the finished surface course.

The method of measurement will be the volume in cubic yards, determined in accordance with Section 203 of the Standard Specifications. The Contractor, at his option, may elect to base the quantity measured on the loose volume at the point of delivery by scaling and counting the loads, with a deduction of 35 percent made for shrinkage. All cost for borrow material including obtaining, hauling, and placing shall be included in the unit price.

(32) SECTION 203: BORROW PITS:

A. PERMITTING OF BORROW PITS

Prior to using borrow material from commercial or other borrow pits located wholly or in part in wetland areas, the contractor shall submit written evidence that operations to obtain fill material from the borrow pit(s) have received all appropriate and necessary authorizations from federal, state, and/or local authorities.

Permitted Borrow Pits

If the appropriate federal, state, and local authorities have issued permits, the contractor shall provide to SCDOT copies of all permits issued for such borrow pit sites.

B. BORROW PITS WITHOUT SECTION 404 PERMIT

For borrow pit sites for which a Section 404 permit under the Clean Water Act has not been issued, the contractor shall provide SCDOT with copies of documentation provided by the contractor or its subcontractor(s) to the U.S. Army Corps of Engineers, which shall, at a minimum, clearly define the location of the borrow pits and any wetlands on the borrow pit site; describe the proposed activities and processes that will be used to prepare the site, obtain fill material from the site, and store material at the site; and request the U.S. Army Corps of Engineers to confirm in writing that no Section 404 permit is required for those operations. No operations shall take place at the borrow sites for at least thirty days from the date of the submission of confirmation request to the U.S. Army Corps of Engineers. After thirty-one days the contractor may begin work. The contractor shall also provide copies to SCDOT of any response(s) provided by the U.S. Army Corps of Engineers to its documentation.

C. RESPONSIBILITY

SCDOT has no obligation or duty to review, assess, evaluate, or act upon such documentation and maintains no authority or responsibility to alter, amend, reject, accept, or otherwise exercise any control over the contractor or subcontractor regarding compliance with Clean Water Act Section 404 and the implementing regulations for Section 404. Documentation submitted to SCDOT is for public information and coordination purposes only. The contractor is responsible for all costs related to the selection, operation, and/or activities at any borrow pit site in wetlands including fines, additional mitigation, and impact delays related to failure to obtain any and all necessary federal, state, and local permits and approvals for borrow pits and operations. Nothing herein shall affect in any way SCDOT's right to accept or reject any fill material not meeting the required technical specifications.

(33) SECTION 203: MUCK EXCAVATION:

September 19, 2011

Section 203.2.1.3 is amended as follows:

Any areas identified on the plans and any additional areas defined by the RCE that are discovered to deflect or settle may require corrective action by the Contractor. This may include undercutting, placing granular aggregate, placing stone aggregate that is separated from other fine aggregate materials by a geotextile for separation of sub-grade and sub-base, and/or additional compacting to the approval of the Engineer.

In areas that require mucking or undercutting, borrow excavation soil may be placed as a bridge lift as long as the grade on which the material is being placed is at least 2 feet above ground water level. In the event that groundwater does not allow backfilling with a borrow excavation soil, a stone or granular material shall be used as the bridge lift material. This stone or granular material shall be in accordance with the Bridge Lift Materials Special Provision. Stone bridge lift materials shall have a thickness of 2 feet and shall extend a minimum of 6 inches above the ground/surface water level. Granular lift materials shall also have a thickness of 2 feet, but shall extend a minimum of 2 feet above ground/surface water level. Individual granular bridge lifts shall not exceed a 2-foot thickness

EXHIBIT 5 – SPECIAL PROVISIONS AND CONTRACT REQUIREMENTS
--

without some type of limited compactive/tamping effort. The depth at which mucking or undercutting shall take place is dependent upon encountering a suitable bearing material within the excavation or a predetermined elevation or depth. In most cases, undercutting shall not exceed 3 to 5 feet in depth, but the final mucking or undercutting thickness shall be based on the decision of the RCE, unless otherwise specified in the project plans and/or specifications. If a suitable bearing soil is not encountered within this depth range or unless otherwise specified in the plans and/or specifications, a P1 biaxial geogrid with an aperture size of less than or equal to 1 inch shall be placed beneath the stone or granular bridge lift material. The geogrid shall be placed in the bottom of the excavation and up the excavation side slopes. If additional compacted borrow excavation soil is needed to reach grade, a geotextile for separation of sub-grade and sub-base shall be placed between any stone bridge lift material and the overlying compacted soil. A bridge lift, consisting of borrow excavation soil or granular bridge lift material, should not be placed within 3 feet of the base of the pavement section. Only compacted borrow excavation soil or stone bridge lift material shall be placed within this zone. The biaxial geogrid shall be in accordance with the Special Provision provided in the project documents.

The quantities associated with mucking and undercutting, i.e. mucking, stone and granular bridge lift materials, geogrid, and geotextile for separation of sub-grade and sub-base, are for bid estimation purposes only. These bid items shall not be purchased and stockpiled on site without written approval from the RCE unless specific areas and details are defined in the plans.

EXHIBIT 5 – SPECIAL PROVISIONS AND CONTRACT REQUIREMENTS

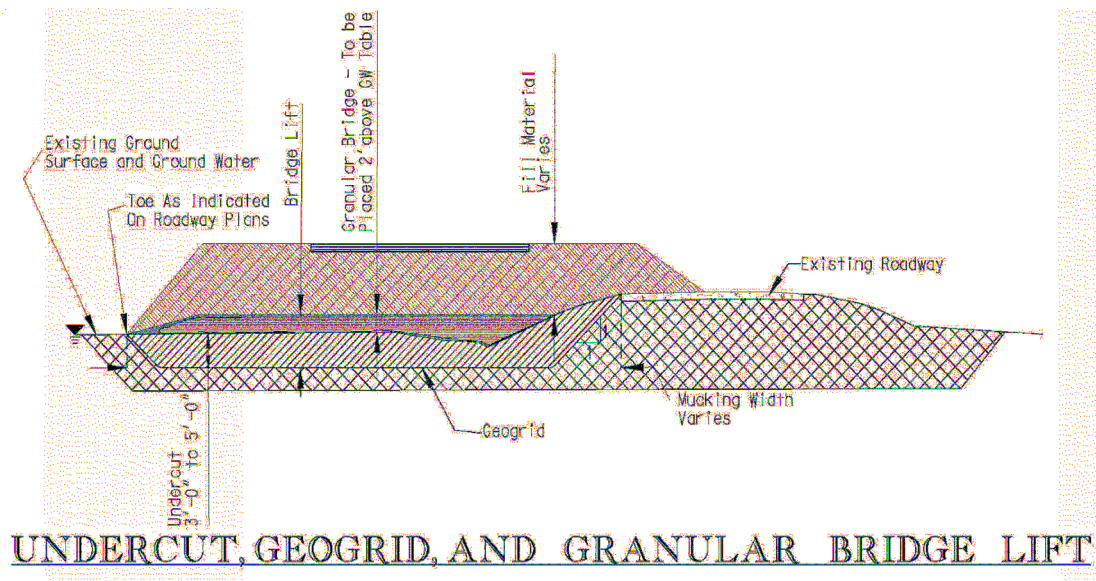
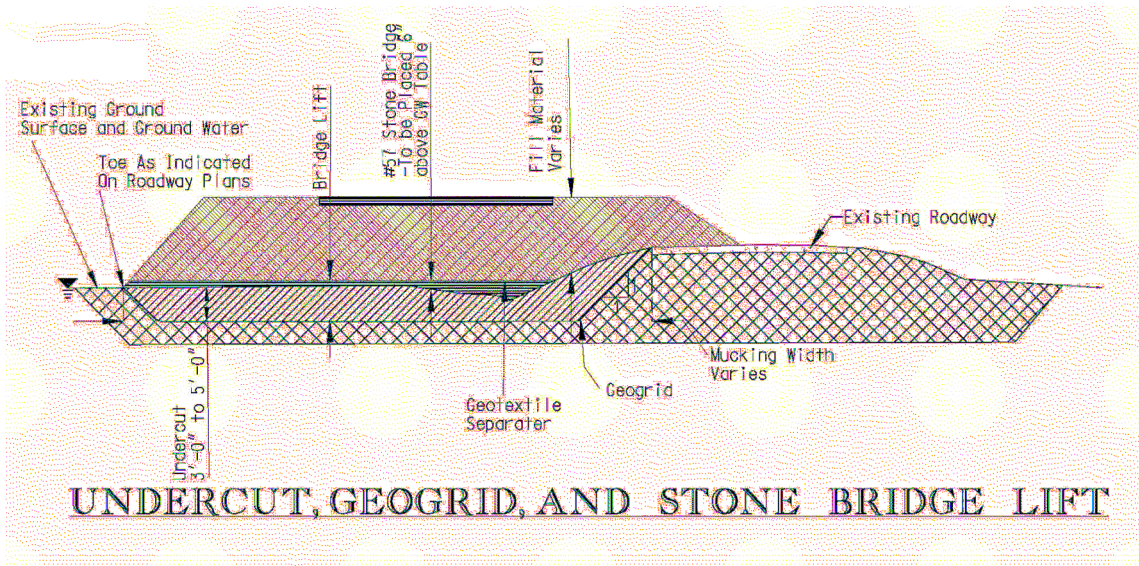

(34) SECTION 204: TEMPORARY SHORING WALL:

Subsection 204.4.5.2 of the Standard Specifications is amended to include the addition of the following section:

"The retaining wall system shall be designed to limit deformations (vertical and lateral displacements) that would affect the stability or performance of any adjacent structures (MSE walls, Bridge foundations, Pavement Structure, Approach Slabs, Embankment (stage construction), etc.). Deformations that must be limited shall include, but not be limited to, vertical settlement, sliding, bulging, bowing, bending, and buckling. Design criteria for allowable deformations shall be dependent on the type of structure that will be influenced by any deformation of the temporary shoring wall. Regardless of the type of structure being retained, the deformation criteria shall not exceed 3 inches without acceptance from the Geotechnical Design Support Engineer. An instrumentation plan for monitoring deformations of the temporary shoring and any adjacent structure shall be submitted along with the shop drawings. The instrumentation plan shall indicate the maximum allowable deformations of the temporary shoring and adjacent structures. Typical instrumentation used for monitoring deformations are survey targets, settlement monuments, crack gages, inclinometers, and tilt monitors. The monitoring locations shall be established in a manner that they can be monitored consistently and obtain repeatable measurements for the entire

construction period. A monitoring schedule that the Contractor will use during construction will also be included with the instrumentation plan. The Contractor shall submit periodic monitoring reports to the RCE in accordance with the approved instrumentation plan. Any changes in frequency of monitoring or report submittal must be sent to the Geotechnical Design Support Engineer for acceptance. If the initial instrumentation plan is found not to be documenting adequately the movements of the temporary shoring or adjacent structures, the Contractor will revise the instrumentation plan and resubmit the revised plan for review and acceptance. If the measured deformations exceed the maximum allowable deformations shown in the instrumentation plan, the Contractor will be required to stop work immediately, and at his own expense, correct the situation to the satisfaction of the Department prior to resumption of construction activities. Extended monitoring after construction may be required if adjacent structures have been affected by the construction. The extended monitoring of the adjacent structures shall continue until the structures have stabilized and the Department concurs with the results and conclusions of the monitoring report. All costs associated with developing the instrumentation plan, purchasing instrumentation, installing instrumentation, and monitoring of the instrumentation shall be included in the unit cost of the temporary shoring item.”

(35) SECTION 205: LIGHTWEIGHT AGGREGATES:

July 23, 2010

A. DESCRIPTION

This work shall consist of furnishing, loading, hauling, placing and compacting lightweight aggregates (either man-made or natural) for use as fill materials in accordance with these specifications. The lightweight aggregate must be manufactured by expanding shale, clay, or slate in a rotary kiln operation or be naturally made. Wood fiber, blast furnace slag, fly ash, shredded tires, or boiler slag will not be allowed. The material must be sub angular to angular conforming to ASTM C 330 (latest edition). The material requirements presented in this specification are appropriate for borrow materials placed in embankments or placed as retained materials. If lightweight aggregates are used as reinforced backfill materials for the construction of Mechanically Stabilized Earth (MSE) walls or other reinforced soil structures, additional material properties, construction, and testing frequency requirements may be required based on the appropriate specifications.

B. MATERIAL

The Lightweight aggregate must have a proven record of durability, be non-corrosive, and conform to the following requirements:

1. pH (AASHTO T-289): pH values shall range between 5 and 10.
2. Organic Content (AASHTO T-267): Organic content shall be less than 0.1 percent (weight of organic material to weight of total sample).
3. Soundness Loss (AASHTO T104): Soundness loss shall be less than 15% when subjected to 5 cycles of Sodium Sulfate.
4. Los Angeles Abrasion (AASHTO T96): Abrasion loss shall be less than 45%.
5. Chloride Content (AASHTO T291): Chloride content shall be less than 100 ppm.
6. Sulfate (AASHTO T-290): Sulfate content shall be less than 200 ppm.
7. Resistivity (ASTM D1125): Resistivity must be greater than 3000-ohm-cm. If resistivity is greater than 5000-ohm-cm, chloride and sulfate requirements and testing are waived.
8. Absorption (AASHTO T19): Absorption must be less than 6%.
9. Gradation (ASTM 136): The gradation will be as shown in the following Table. Other gradations may be acceptable upon approval by the Engineer.

Table – Lightweight Aggregate Gradation

EXHIBIT 5 – SPECIAL PROVISIONS AND CONTRACT REQUIREMENTS

Sieve Size or Number	Percent Passing
¾ inch	100
½ inch	90 – 100
3/8 inch	50 – 90
No. 4	0 – 50
No. 8	0 – 20
No. 16	Less than 10
No. 30	Less than 10
No. 50	Less than 5
No. 100	Less than 5

10. The coefficient of uniformity, C_u , shall be 4 or greater. The coefficient of uniformity, C_u , shall be computed as follows:

$$C_u = \frac{D_{60}}{D_{10}}$$

Where D_{60} is the particle diameter at 60% passing and D_{10} is the particle diameter at 10% passing. Written approval from the DOC will be required to use soils with a coefficient of uniformity, C_u , less than 4.

11. Aggregate loose unit weight (ASTM C29): The loose unit weight must be less than 45 lbs/ft³.
12. In-place density: (ASTM D4253, and D4254): The in-place compacted dry unit weight must be between 55 and 60 lbs/ft³. Material must be compacted to a minimum 65% relative density as determined by ASTM D4253 and D4254. Use a vibratory table when determining the maximum index density and unit weight in accordance with ASTM D4253. Determine the minimum index density and unit weight in accordance with ASTM D4254.
13. Angle of Internal Friction (AASHTO T 236): The minimum angle of internal friction must be 40 degrees. Test a saturated representative sample (with particles larger than 0.75 inch removed) in a round or square shear box that is a minimum of 12 inches across. Test sample shall be compacted to a minimum 65% relative density as determined by ASTM D4253 and D4254.

C. CONSTRUCTION

Place the lightweight fill in uniform layers. When required by the Engineer, compact each layer using vibratory compaction equipment weighing no more than 10 tons. Place layers no more than 12 inches in depth loose thickness and compact. Compact with three passes of an 8 – 10 ton vibratory roller in the vibratory mode if necessary, or as directed by the Engineer. In confined areas use vibratory plate compaction equipment (5 hp to 20 hp) with a minimum of two passes in 6" lifts for a 5 hp plate and 12" lifts for a 20 hp plate. The contractor must take all necessary precautions when working on or near the lightweight fill to ensure that the material is not over compacted. Construction equipment, other than for placement and compaction, must not operate on the exposed lightweight fill. Low ground pressure equipment (D6 LGP or lighter) is recommended for spreading and placing the lightweight aggregate.

D. TESTING FREQUENCY

All soil property requirements shall be tested during initial source evaluation or if a change in source is requested. Lightweight aggregate material shall be sampled once every 2,000 cubic yards and tested for gradation and pH. Lightweight aggregate material shall be sampled once every 5,000 cubic yards and tested for internal friction angle, organic content, resistivity, chloride content, and sulfate content. Chloride and sulfate content testing will not be required if resistivity test results indicate 5000 ohm-cm or greater. The internal friction angle shall be tested every 2,000 cubic yards if the gradation indicates that the coefficient of uniformity, C_u , is less than 4. A variation in testing frequency may be required if a variation in material gradation or composition is observed.

EXHIBIT 5 – SPECIAL PROVISIONS AND CONTRACT REQUIREMENTS

E. MEASUREMENT AND PAYMENT

Measurement of lightweight aggregate shall be the actual volume in-place at the project site. All costs for furnishing, loading, hauling, placing and compacting lightweight aggregates (either man-made or natural) shall be included in the unit price of the lightweight aggregates.

Payment will be made under:

Item No.	Pay Item	Pay Unit
2033020	BORROW EXCAVATION (LIGHTWEIGHT)	CY

(36) SECTION 205: HIGH-STRENGTH GEOTEXTILE FOR EMBANKMENT REINFORCEMENT:

April 21, 2015

A. DESCRIPTION

This work shall consist of furnishing and installing construction geotextiles in accordance with the details shown in the plans, specifications, or as directed by the RCE.

B. MATERIALS

A geotextile is defined as any permeable polymeric textile used with foundation, soil, rock, earth, or any other geotechnical engineering related material, as an integral part of a civil engineering project, structure, or system. Use geotextiles and thread used in joining geotextiles manufactured from fibers consisting of long-chain polymers, composed of at least 95 percent by weight of polyolefins or polyesters. Use geotextiles with fibers formed into a stable network such that the fibers or yarns retain their dimensional stability relative to each other, including selvages (edges) during shipping, handling, placement, and in service. Use geotextile free from defects or tears.

- 1. Minimum Average Roll Values:** All property values, with the exception of Apparent Opening Size (AOS), represent Minimum Average Roll Values (MARV) in the weakest principal direction. Provide geotextiles whose average test results from any roll sampled in a lot for conformance or quality assurance testing meets or exceeds minimum values provided in this Section.
- 2. Apparent Opening Size:** Values for Apparent Opening Size (AOS) represent maximum average roll values. Acceptance will be based on ASTM D 4759.
- 3. Reinforcement Geotextile:** Use reinforcement geotextile within existing and/or proposed fills for slope reinforcement.

Furnish geotextiles meeting the property requirements outlined in Table 1.

Table 1: High Strength Geotextile Properties (Design Requirements)^{1,2}

Property	Test Method	Geotextile Property Requirements
Long-Term Design Strength, T_{al} , MD		22,800 lb/ft
Long-Term Design Strength, T_{al} , XD		2,280 lb/ft
Sewn Seam Breaking Strength ³	ASTM D4884	900 lbs/ft
AOS	ASTM D4751	$\leq (1.0 \text{ to } 2.0)D_{85(\text{soil})}$
Permeability	ASTM D4491	$\geq 10k_{\text{soil}}$
Default Pullout Friction Factor, F^*	ASTM D6706	$0.6 \tan \Phi$
Default Alpha, α	ASTM D6706	0.6
Ultraviolet Stability	ASTM D4355	$\geq 50\%$ after 500 hrs of exposure

- Notes:
- The test procedures shall conform to the most recently approved ATSM geotextile test procedures.
 - All numeric values represent Minimum Average Roll Value (MARV).
 - Applies to factory or field sewn seams.

4. Source Approval and Certification

EXHIBIT 5 – SPECIAL PROVISIONS AND CONTRACT REQUIREMENTS

Prior to construction, the Contractor shall submit to the Resident Construction Engineer (RCE) a Certification Package prepared by the geotextile reinforcement manufacturer. The Contractor shall allow 21 calendar days from the day the submittals are received by the RCE for review and acceptance. Submit the following information regarding each geotextile proposed for use:

- a. Manufacturer's name and current address;
- b. Full product name/number, including roll number;
- c. Geosynthetic material (i.e. polymer type) and structure (including fiber/yarn type);
- d. Proposed geotextile use(s); and
- e. Certified test results for the properties outlined in Table 1 and below in Section 4.

The Certification shall state that the furnished geotextile soil reinforcement is in full compliance with the design requirements as stated in this specification and the design drawings and is fit for use in long-term critical soil reinforcement applications. In addition to the minimum required properties in Table 1, the submittal shall also certify the following values for each geotextile soil reinforcement used on the project:

- a. The ultimate tensile strength, T_{ULT} , (MARV) for geogrid soil reinforcements, MD/XD
- b. The tensile strength at 5% strain, MD
- c. The creep reduced tensile strength, MD
- d. The geotextile's pullout coefficients (F^* , α)

The Contractor's submittal package shall include, but not be limited to, actual test results for tension, creep, durability, construction damage, joint/seam strength, pullout and quality control. A person having the legal authority to bond the manufacturer shall attest to the certificate. Any tests required shall be performed at no additional cost to the Department. If in the opinion of the RCE, the required documentation is not provided for individual reduction factors (RF) or pullout coefficients (F^* , α), default values for these design parameters shall be used in accordance with this specification.

a. Ultimate Tensile Strength (T_{ult}):

The ultimate tensile strength, T_{ult} , shall be determined from wide width tensile tests (ASTM D 4595). Geotextile samples tested in accordance with ASTM D 4595 shall be with an 8-inch width specimen, or a 4-inch specimen width with correlation to an 8-inch width. Correlation methodology shall be submitted to, and is subject to acceptance by the RCE. All geotextile strength tests (ASTM D 4595 and ASTM D 6637) shall be conducted at a strain rate of 10% per minute based on actual gage length necessary to meet the testing sample dimension requirements. Laboratory test results documenting the ultimate tensile strength, T_{ult} , in the reinforcement direction shall be based on the minimum average roll values (MARV) for the product.

b. Long-Term (Allowable) Design Tensile Strength (T_{al}):

The allowable tensile load per unit width of geotextile soil reinforcement, T_{al} , in accordance to the backfill type used shall be computed as follows:

$$T_{al} = \frac{T_{ult}}{RF}$$

c. Reduction Factor (RF):

EXHIBIT 5 – SPECIAL PROVISIONS AND CONTRACT REQUIREMENTS

The total reduction factor, RF, is the combined reduction factor for long-term degradation due to installation damage, creep, and durability. The total reduction factor, RF, shall be defined as follows:

$$RF = RF_{ID} \times RF_{CR} \times RF_D \geq 3.0$$

The individual reduction factors shall be documented in accordance with the site conditions, design calculations, and specifications. When sufficient documentation is not provided for individual reduction factors, RF_{ID} , RF_{CR} , and RF_D , a reduction factor RF of 7.0 shall be used. The reinforcement manufacturer shall certify and document the individual reduction factors as follows:

d. Installation Damage Reduction Factor (RF_{ID}):

The reduction factor for installation damage, RF_{ID} , shall be documented by field and laboratory test results and literature review, as described in ASTM D 5818 for the reinforced backfill specified or for more severe soils. Samples subjected to installation damage shall be tested for tensile strength and deformation characteristics in accordance with ASTM D 4595. Recommended values for reduction factors for installation damage (RF_{ID}) for various soils shall also be documented. The minimum installation damage reduction factor, RF_{ID} , shall be 1.1, regardless of product specific test results.

e. Creep Reduction Factor (RF_{CR}):

Laboratory test results documenting creep performance over a range of load levels, for a minimum duration of 10,000 hours based on tension creep test (ASTM D 5262) shall be required. Creep test samples shall be of sufficient width to be representative of overall product creep response (fiber creep testing will not be accepted).

The creep-limiting strength, T_i , shall be based on extrapolating the 10,000 hours (or longer duration) tension creep tests to a 75-year design life, unless a 100-year design life is specified in the plans. The creep extrapolation method shall be based on methods described in FHWA NHI-10-025, *"Design and Construction of Mechanically Stabilized Earth Walls and Reinforced Soil Slopes"* - Appendix "D". Laboratory test results and extrapolation methodology shall be documented.

The reduction factor for creep, RF_{CR} , is defined as the ratio of the average lot specific ultimate tensile strength, T_{ULTLOT} , to the creep-limiting strength, T_i . The average lot specific ultimate tensile strength, T_{ULTLOT} , for the lot of material used for creep testing, T_{ULTLOT} , shall be determined from wide width tensile test, ASTM D 4595.

f. Durability Reduction Factor (RF_D):

The total reduction factor for durability, RF_D , shall be defined as the combined effects of chemical and biological degradation. Laboratory test results, extrapolation techniques, and a comprehensive literature review shall document the reduction factor for durability for all material components in accordance with FHWA NHI-09-087, *"Corrosion / Degradation of Soil Reinforcements for Mechanically Stabilized Earth Walls and Reinforced Soil Slopes"*. The minimum durability reduction factor, RF_D , shall be 1.1, regardless of product specific test results.

g. Soil Reinforcement Pullout Coefficients (F^* , α):

The Certification Package shall document the pullout coefficients (F^* , α) meet or exceed the required coefficients necessary to obtain the T_{al} provided above where,

$F^* = \text{Minimum pullout friction factor} = C_i \tan \Phi$,

$C_i = \text{Soil interaction coefficient} \geq 0.6$

$\Phi = \text{Soil Angle of Internal Friction}$

The pullout friction factor, F^* , and the scale effect correction factor, α , shall be documented by laboratory testing from pullout tests. Pullout testing shall be conducted for site-specific materials or for materials representative of the reinforced backfill at confining pressures specified by the Engineer. When laboratory tests are used from representative soils, the representative soils shall be documented by providing the soil's angle of internal friction, gradation, and coefficient of uniformity ($C_u = D_{60}/D_{10}$). Recommended pullout coefficients for various soil types shall also be documented. The pullout coefficients shall be determined by using the quick effective stress pullout tests ("Measuring Geosynthetic Pullout Resistance in Soil" per ASTM D 6706). The soil interaction coefficient, C_i , shall be documented when computing the pullout friction factor, F^* . When sufficient documentation is not provided for pullout coefficients, F^* and α , and the coefficient of uniformity, C_u , is greater or equal to 4, the default values indicated in this specification can be used. If the coefficient of uniformity of the reinforced backfill is less than 4, laboratory pullout test shall be required to determine pullout friction factor, F^* , and the default scale effect factor, α .

5. Sample Approval.

To confirm that the on-site geotextile meets the property values specified, random samples shall be submitted to the RCE for evaluation. The machine direction shall be marked clearly on each sample submitted for evaluation. The machine direction is defined as the direction perpendicular to the axis of the roll.

Cut a sample from the geotextile roll with the minimum dimensions of 4 feet by the full width of the roll beyond the first wrap. The geotextile samples shall be cut from the roll with scissors, sharp knife, or other suitable method that produces a smooth edge and does not cause geotextile ripping or tearing. Submit a manufacturer's certificate of compliance signed by an authorized manufacturer's official. The certificate must attest that the geotextile meets all the Minimum Average Roll Value (MARV) requirements specified in Table 1 as evaluated under the manufacturer's quality control program. Geotextiles supplied for construction of the project shall be certified in accordance with the following criteria. The tests described in the specification shall be conducted by the manufacturer or by an approved independent testing laboratory on samples taken from the same lot number as the material actually shipped to the project and at the specified frequency. The manufacturer or independent testing laboratory shall maintain the appropriate accreditations and must be preapproved by the Department. All rolls shall be marked with individual and distinct roll numbers. All roll numbers shall have traceable certified mill test reports from the given lot that they were manufactured. These test reports must be supplied to the Department prior to installation of any geotextile materials. After the sample and the required information have been submitted to the RCE, allow 30 calendar days for evaluation.

Product acceptance is determined by comparing the average test results of all specimens within a given sample to the Minimum Average Roll Values (MARV) listed in Table 1. Install geotextiles only after the material has been tested and/or evaluated and accepted. Replace all geotextiles installed prior to acceptance that do not meet specifications at Contractor's expense.

a. Sewn Seam Approval

If the geotextile seams are to be sewn in the field, the Contractor shall provide a section of sewn seam that can be sampled by the RCE before the geotextile is installed. The sewn seam shall be in accordance with ASTM 6193.

The seam sewn for sampling shall be sewn using the same equipment and procedures as will be used to sew the production seams. The seam sewn for sampling must be at least 6 feet in length. If the seams are sewn in the factory, the Contractor shall provide samples of the factory seam at random from any of the rolls to be used. Regardless of whether the seam is to be sewn in the factory or the field, the manufacturer and/or

Contractor shall certify that the strength meets the requirement set forth in Table 1. If seams are to be sewn in both the machine and cross-machine direction, provide samples of seams from both directions. The seam assembly description shall be submitted by the Contractor to the Engineer and will be included with the seam sample obtained for testing. This description shall include the seam type, stitch type, sewing thread type(s), and stitch density.

If sewn seams are used for seaming the geotextile, use thread that consists of high strength polypropylene or polyester. Do not use nylon thread. Use thread that is of contrasting color to that of the geotextile itself.

If the manufacturer can provide a T_{al} MD that is greater than the sum of the required T_{al} MD and sewn seam breaking strength (for each specified in the project plans), the sewn seams may be eliminated and a minimum overlap of 1 foot may be used.

6. Identification, Shipment and Storage

Conform to ASTM D 4873, *Standard Guide for Identification, Storage, and Handling of Geotextiles*. Clearly label each roll of geotextile shipped to the project with the name and address of the manufacturer, full product name/number, quantity, and roll number.

The RCE will reject materials that are mislabeled or misrepresented. Wrap each roll with a material that protects the geotextile, including ends of the roll, from damage due to shipment, water, sunlight, and contaminants. Maintain the protective wrapping during periods of shipment and storage. Do not damage the geotextile or wrapping when unloading or transferring from one location to another. Do not drag the rolls.

During storage, elevate geotextile rolls off the ground and adequately cover to protect them from the following:

- a. Site construction damage;
- b. Precipitation;
- c. Ultraviolet radiation including sunlight;
- d. Chemicals that are strong acids or strong bases;
- e. Flames including welding sparks, temperatures in excess of 140 °F (60 °C); and
- f. Mud, dirt, dust, debris and any other environmental condition that may damage the physical property values of the geotextile

C. CONSTRUCTION REQUIREMENTS

1. General

Prepare the surface on which the geotextile is to be placed so that no damage occurs to the geotextile. Do not drive or operate any construction equipment directly on the geotextile. Dispose of material with defects, rips, holes, flaws, deterioration, or other damage. Do not use defective material in the work. The manufacturer shall be present on site for a minimum of two days of geotextile installation such that the manufacturer observes any field-sewn seams.

2. Installation Plan

Within thirty (30) calendar days after award of the contract or no later than thirty (30) calendar days before beginning high-strength geotextile installation, the Contractor shall submit to the Department for review a high-strength geotextile installation plan that includes as a minimum the following information:

- a. The Contractor shall certify and provide proof to the Department of experience in the work described. The Contractor shall have successfully installed at least 500,000 square yards of any geotextile that has sewn seams during the last five years. In addition, the

Contractor shall have successfully completed at least five projects within the last five years of similar size and complexity to that of the Project.

The Contractor's experience shall be documented by providing a project summary that includes for each referenced project, the project start and completion dates, total quantity of geotextile installed (specifically indicate if high-strength geotextile installed), and a detailed description of the project, site conditions, and subsurface conditions. The project description shall include details of the geotextile materials, the equipment and technique used to install the geotextiles, the average and maximum area of geotextile installed, the client name and address, the name and telephone number of the representative of the consultant and owner for whom the work was performed and who can attest to the successful completion of the work, and any other information relevant to demonstrating the Contractor's qualifications.

- b. Resume of supervisor documenting experience and qualifications in the installation of both normal and high-strength geotextile. The Contractor shall have a full-time supervisor who has been in responsible charge of supervising geotextile installation operations for at least five projects in the last five years. The supervisor shall be present at the work site at all times during installation operations. The acceptability of the supervisor, as well as any replacement for the supervisor, will be subject to the approval of the Department.
- c. Shop drawings showing the planned locations and elevations of all high-strength geotextiles. The installation sequence shall also be provided including any required staging. The shop drawings shall also show the location of the bridge abutment, and the limits of the final embankment and construction staging.
- d. Detailed description of proposed installation procedures
- e. Proposed methods and equipment for sewn seams

3. Site Preparation

Prepare the installation site by clearing, grubbing, and excavating or filling the area to the design grade. This includes removal of topsoil or vegetation. The RCE will identify soft spots and unsuitable areas during site preparation. This may include but not be limited to proof-rolling specific areas defined by the RCE. Excavate these areas and backfill with approved borrow or bridge lift material and compact as specified. The area to be covered by the geotextile shall be graded to a smooth, uniform condition free from ruts, potholes, and protruding objects such as rocks or sticks.

The Contractor may construct a working platform, up to 2 feet in thickness, in lieu of grading the existing ground surface. A working platform is required where stumps or other protruding objects which cannot be removed without excessively disturbing the subgrade are present. These areas shall be prepared in accordance with the 2007 Standard Specifications for Highway Construction. The stumps shall be covered with at least 6 inches of fill before placement of the first geotextile layer.

4. Geotextile Placement

The geotextile shall be spread immediately ahead of the covering operation. The geotextile shall be laid with the machine direction perpendicular or parallel to centerline as shown in Plans. All seams shall be sewn. Seams to connect the geotextile strips end to end will not be allowed. The geotextile shall not be left exposed to sunlight during installation for a total of more than 14 calendar days. The geotextile shall be laid smooth without excessive wrinkles. Under no circumstances shall the geotextile be dragged through mud or over sharp objects, which could damage the geotextile.

Small soil piles or the manufacturer's recommended method shall be used as needed to hold the geotextile in place until the specified cover material is placed. Remove wrinkles and folds by pulling the geotextile taut as required.

Should the geotextile be torn or punctured or the sewn joints disturbed, as evidenced by visible geotextile damage, subgrade pumping, intrusion, or roadbed distortion, the backfill around the damaged or displaced area shall be removed and the damaged area repaired or replaced by the Contractor at no expense to the Department. The repair shall consist of a patch of the same type of geotextile placed over the damaged area. The patch shall be sewn at all edges.

If geotextile seams are to be sewn in the field or at the factory, the seams shall consist of two parallel rows of stitching, or shall consist of a J-seam, Type SSn-2. The two rows of stitching shall be 1 inch apart with a tolerance of plus or minus 0.5 inches and shall not cross, except for re-stitching. The stitching shall be a lock-type stitch. The minimum seam allowance, i.e., the minimum distance from the geotextile edge to the stitch line nearest to that edge, shall be 1.5 inches if a flat or prayer seam, Type SSa-2, is used. The minimum seam allowance for all other seam types shall be 1 inches. The seam, stitch type, and the equipment used to perform the stitching shall be as recommended by the manufacturer of the geotextile and as approved by the RCE.

The seams shall be sewn in such a manner that the seam can be inspected readily by the RCE or his representative. The seam strength will be tested and shall meet the requirements stated herein.

5. Fill Placement.

Embankment construction shall be kept symmetrical at all times to prevent localized bearing capacity failures beneath the embankment or lateral tipping or sliding of the embankment. Place fill over the geotextile by dumping onto previously placed material and pushing the material into place. Stockpiling of fill on the geotextile will not be allowed. Do not operate any construction equipment directly on the geosynthetic material under any circumstances.

Place the fill material in uniform layers so that there is a minimum lift thickness (loose) of 8 inches between the geosynthetic material and equipment tires or tracks at all times. The minimum thickness of the first lift is 8 inches. Do not allow construction equipment to turn on the first lift of material above the geosynthetic material. Do not blade the first lift placed over the geosynthetic material. If the subgrade is very soft with an undrained shear strength less than 500 psf, minimize pile heights to less than 3 feet and spread piles as soon as possible after dumping to minimize the potential for localized subgrade failure due to overloading of the subgrade.

Do not use sheepsfoot or studded compaction equipment on the first lift placed over the geosynthetic material. Stop vibrator on compaction equipment if pumping occurs. Do not operate any construction equipment that results in rutting in excess of 3 inches on the first lift. If rutting exceeds 3 inches, decrease the construction equipment size and/or weight or increase the lift thickness. Use only rubber-tired rollers for compaction if any foundation failures occur when placing subsequent lifts. Compact all lifts to the moisture and density requirements for each embankment specified in the Standard Construction Specifications. Do not blade material down to remove ruts. Fill any ruts or depressions with additional material and compact to the specified density.

A sandy material that meets the requirements of an A-2 AASHTO soil classification shall be the only borrow excavation soil allowed for placement between the lowest elevation geotextile and the bottom of the pavement section. The embankment fill soils shall be compacted in accordance with the 2007 Standard Specifications for Highway Construction. Fill shall be placed in 12-inch maximum lift thicknesses where heavy compaction equipment is to be used and 6-inch maximum uncompacted lift thicknesses where hand-operated equipment is used.

The geotextile shall be pretensioned during installation using either Method 1 or Method 2 as described herein. The method selected will depend on whether or not a mudwave forms

EXHIBIT 5 – SPECIAL PROVISIONS AND CONTRACT REQUIREMENTS

during placement of the first one or two lifts. If a mudwave forms as fill is pushed onto the first layer of geotextile, Method 1 shall be used. Method 1 shall continue to be used until the mudwave ceases to form as fill is placed and spread. Once mudwave formation ceased, Method 2 shall be used until the uppermost geotextile layer is covered with a minimum of 1 foot of compacted fill. These special construction methods are not needed for fill construction above this level. If a mudwave does not form as fill is pushed onto the first layer of geotextile, then Method 2 shall be used initially and until the uppermost geotextile layer is covered with at least 1 foot of compacted fill.

Method 1

After the working platform, if needed, has been constructed, the first layer of geotextile shall be laid as outlined in the project plans and the joints sewn together. The geotextile shall be stretched manually to ensure that no wrinkles are present in the geotextile. The fill shall be end-dumped and spread from the edge of the geotextile. The fill shall first be placed along the outside edges of the geotextile to form access roads. These access roads will serve three purposes: to lock the edges of the geotextile to form access roads, to contain the mudwave, and to provide access as needed to place fill in the center of the embankment. These access roads shall be approximately 16 feet wide. The access roads at the edges of the geotextile shall have a minimum height of 2 feet completed. Once the access roads are approximately 50 feet in length, fill shall be kept ahead of the filling operation, and the access roads shall be kept approximately 50 feet ahead of this filling operation. Keeping the mudwave ahead of this filling operation and keeping the edges of the geotextile from moving by use of the access roads will effectively pre-tension the geotextile. The geotextile shall be laid out no more than 20 feet ahead of the end of the access roads at any time to prevent overstressing of the geotextile seams.

Method 2

After the working platform, if needed, has been constructed, the first layer of geotextile shall be laid and sewn as in Method 1. The first lift of material shall be spread from the edge of the geotextile, keeping the center of the advancing fill lift ahead of the outside edges of the lift. The geotextile shall be manually pulled taut prior to fill placement. Embankment construction shall continue in this manner for subsequent lifts until the uppermost geotextile layer is completely covered with 1 foot of compacted fill.

D. METHOD OF MEASUREMENT

Measurement of geotextile is on a square yard basis and will be computed based on the total area of geotextile shown in the plans, exclusive of the area of geotextiles used in any overlaps, seams, and/or joints. This shall include all costs associated with installation of the geotextile. Overlaps and any geotextile waste are an incidental item.

E. BASIS OF PAYMENT

Payment at the contract unit price is full compensation for all resources necessary to complete the item of work under the contract. Payment for the completed and accepted quantities is made under the following:

Item No.	Pay Item	Unit
2037110	GEOTEX REINF.	SY

(37) SECTION 205: MONITORING DEVICES – PIEZOMETER:

May 09, 2013

Supplemental Specification for Monitoring Devices – Piezometer is revised as follows:

Section 2 Paragraphs 2 and 3 shall be replaced with the following:

EXHIBIT 5 – SPECIAL PROVISIONS AND CONTRACT REQUIREMENTS

“Piezometer shall be installed from the working surface to the depths shown on the plans. These depths refer to the middle of the piezometer referenced to the original ground surface. Enough cable shall be provided to run from the pressure cell to the location of the Vibrating Wire Data Collection Center (VW-DCC) plus 10 feet for each instrument. The cable used to connect the pressure cell to the VW-DCC shall meet the requirements of the instrument manufacturer/supplier. The Contractor shall supply non-conductive conduit to encase the cable between the pressure cell and VW-DCC. The conduit shall have a minimal nominal diameter of 1 inch and meet the requirements of Schedule 80 materials. Provide enough conduit to enclose all lengths of buried cable from the pressure cells to the VW-DCC. All connects in the conduit and in the cable between the pressure cell and VW-DCC shall be water proof.

During roadway construction and any delay period for settlement, the piezometers will be read and analyzed by the Engineer at the same times outlined in the Special Provision for Settlement Plates. If the piezometers indicate excessive excess pore pressures at a given location during embankment placement operations, the placing of embankment material shall be suspended.”

The following shall be added to the end of Section 2 Paragraph 4:

“Figure 1 depicts the installation of a single piezometer in a borehole; however, multiple piezometers may be placed in the same borehole. The installation of multiple piezometers is not shown for clarity.”

Section 4 Paragraph1 shall be replaced with the following:

“Unit price bid for "Monitoring Devices-Piezometer" shall include all costs associated with supplying, installing, and maintaining the monitoring devices. The Contractor will monitor the devices throughout construction of the embankment and for up to a period of one year after the final delay period for settlement when embankment construction is completed. The Contractor will be responsible for ensuring the piezometers are in working order and accessible once the embankment is complete.”

(38) SECTION 205: SETTLEMENT SENSORS:

August 25, 2015

A. GENERAL

1. Scope

The work under this Section consists of furnishing all supervision, labor, material, equipment, and related services necessary to furnish and install settlement sensors as indicated on the Drawings and specified herein. The Contractor shall accommodate the Engineer in the monitoring of settlement sensors.

The purpose of the settlement-monitoring program is to:

- a. Confirm estimates of the time rate of settlement of embankments and retaining walls during construction so that construction methods may be adjusted, if necessary, to meet the project schedule;
- b. Confirm that settlement is sufficiently completed prior to final grading and paving of roadways supported on embankments and retaining walls.

Consolidation settlement of the foundation soils is expected to occur during and for a period after construction of new embankments and retaining walls. The magnitude and rate of the settlement will depend on the variation of the stratigraphy and consolidation properties of the foundation soils. To effectively manage the post-construction settlement, settlement sensors shall be used to monitor the magnitude and rate of settlement during construction.

EXHIBIT 5 – SPECIAL PROVISIONS AND CONTRACT REQUIREMENTS

Settlement sensors shall be furnished and installed by the Contractor in the presence of the Engineer. Settlement sensors shall consist of a steel plate with the attached sensor equipment designed to be buried within soil fill and connected to a liquid reservoir, which is set in stable ground that is not subject to settlement. Settlement measurements are referenced to the fluid level of the reservoir supported on stable ground.

2. Responsibilities of Contractor:

The Contractor shall notify the Engineer at least five (5) working days prior to the installation of settlement sensors.

The Contractor shall furnish and install the settlement sensors in the presence of the Engineer.

The Contractor shall provide a licensed surveyor to stake out and provide as-built locations and elevations of all settlement sensors and liquid reservoir locations.

The Contractor shall protect the settlement sensors and liquid reservoirs from damage for the duration of the Contract.

The Contractor shall provide the Engineer safe access to the settlement sensors for the purpose of data collection for the duration of the Contract.

The Contractor shall be responsible for locating all settlement sensors in the field and ensuring that no conflicts exist between settlement sensors, liquid reservoir locations and existing and proposed structures, utilities or other construction proposed or present at the site.

3. Site Preparation

The Contractor shall ensure a firm base on which heavy equipment and/or other necessary equipment can be operated safely under its own power for installation of settlement sensors.

The Contractor shall accurately locate all settlement sensors in accordance with Drawings. Settlement sensors shall be adjusted by the Contractor, with the approval of the Engineer, to avoid utilities, foundations, and all other underground construction.

4. Existing Soil Conditions:

The subsurface conditions encountered at the site are presented in the Contract Plans and documents.

B. PRODUCTS

1. Settlement Sensor

The settlement sensor shall consist of a 12-in. square, 1/4-in. thick steel plate with an attached vibrating wire pressure sensor. A liquid reservoir and readout panel shall also be supplied in a waterproof casing. The Contractor shall supply weather resistant locks and keys for the casings. The Contractor shall provide all keys to the Engineer. The liquid reservoir shall have a graduated scale attached so that the liquid level can be checked visually. The manufacturer's instruction and installation manual shall be supplied with the settlement sensor. The sensor shall have the signal cable and tubing attached and factory saturated with a 50% ethylene glycol antifreeze solution, ready for connection to the readout panel and liquid reservoir. The liquid reservoir shall have two tubing connections to the sensor to allow for flushing if necessary. Additional antifreeze solution shall be provided to fill the liquid reservoir and saturate the tubing connections. The vibrating wire pressure sensor shall be self-compensated for variations in barometric pressure, and have a built in temperature sensor for correction of temperature variations. The vibrating wire sensor shall

EXHIBIT 5 – SPECIAL PROVISIONS AND CONTRACT REQUIREMENTS

be vented to the air space at the top of the liquid reservoir to accomplish the self-compensation for barometric pressure, and a moisture trap shall be included in series with the vent tubing. The settlement sensor shall have a minimum range of 5 ft, a resolution of 0.01 ft, and a system accuracy of ± 0.02 ft. All above ground components of the settlement sensor system shall be insulated.

Settlement sensor model 4650 manufactured by Geokon, Inc. of Lebanon, NH, or equivalent, shall be supplied. Catalog sheet for 4650 Settlement sensor is attached at the end of this specification for reference.

2. Support Post

A metal or wooden post shall be provided for mounting the liquid reservoir and readout panel. The post shall be long enough so that it can be set a minimum of 3-ft below the stable ground surface, and the readout panel will be mounted no less than 2-ft off of the ground.

3. Sand Backfill

Clean sand backfill with no particles larger than 3/8-in. shall be provided to backfill around the signal cable and tubing leading from the settlement plate to the liquid reservoir and readout panel.

4. Incidentals

Incidental conduit, hardware, fasteners, tools, electronic readouts and the like, as necessary to install the system in accordance with the manufacturer's manual, shall be provided.

C. SUBMITTALS

The Contractor shall submit the Specification sheet for the settlement sensor prior to purchase of settlement sensor for review and approval of the Engineer. Locations for the liquid reservoir shall also be submitted for approval, so that the proper length of signal cable and tubing can be purchased.

Upon receipt of the settlement sensor, the Contractor shall submit copies of calibration sheets and the manufacture's installation and instruction manual for review and approval of the Engineer, and shall make available the settlement sensor for inspection by the Engineer.

Within 1 week following installation, the contractor shall submit an installation record for each settlement plate which includes the plate designation, station, offset, and elevation of the Settlement sensor, and station offset and elevation of the liquid reservoir. The settlement sensor shall be located to an accuracy of 0.01 ft (both vertically and horizontally).

D. EXECUTION

1. Settlement Sensor Installation

The Contractor shall furnish and install settlement sensors in accordance with the Drawings and these specifications and in the presence of the Engineer. Settlement sensors shall be installed prior to embankment or retaining wall construction and following installation of wick drains, stone columns, or other ground improvement, and grubbing and clearing in the immediate vicinity of each settlement plate. Settlement sensor locations shall be adjusted by the Contractor only with the approval of the Engineer.

Settlement sensor installation shall be in accordance with the manufacturer's recommendations as presented in their instruction and installation manual. The liquid reservoir shall be located clear of the construction area, in an area where no fill will be placed and no settlement is anticipated. The liquid reservoir and readout panel shall not be located in drainage swales, storm water detention ponds or other areas where the panel may become submerged. A licensed surveyor shall provide a survey of the installed sensor

EXHIBIT 5 – SPECIAL PROVISIONS AND CONTRACT REQUIREMENTS

and liquid reservoir. The survey reference point for the liquid reservoir and readout panel shall be permanently marked so that subsequent surveys may be referenced to this mark.

2. Allowance for Settlement Sensor Monitoring

The contractor shall accommodate the Engineer during construction to provide safe and timely access to settlement sensors for the purpose of obtaining measurements, as construction progresses. Evaluation of the settlement sensor data will be the responsibility of the Engineer.

3. Fill Height Survey and Liquid Reservoir Survey

The Contractor shall make a survey of the ground surface elevation above each settlement sensor twice weekly while fill is being placed, and once every two weeks when fill is not being placed, unless directed otherwise by the Engineer. The purpose of these measurements is to provide the Engineer with a time-history of the embankment or retaining wall height for correlation with settlement measurements. Survey of the liquid reservoir and readout panel elevation shall be made every four weeks, or if disturbance of the liquid reservoir is suspected, or as directed by the Engineer. Surveys made by the Contractor shall be provided to the Engineer within one week.

4. Protection of Settlement Sensors

The Contractor shall protect settlement sensors from damage and vandalism for the duration of the Contract and repair or replace damaged or inoperative settlement sensors at no cost to the Department.

5. Abandonment of Settlement Sensors

Once the Engineer has determined that the settlement sensors have served their purpose and are no longer needed, they shall be abandoned in-place. The Contractor shall remove recoverable portions of the settlement sensor, likely consisting of only the liquid reservoir and readout panel. All recoverable instrumentation shall remain property of the Contractor. The Contractor shall remove the ethylene glycol antifreeze solution from the buried tubing that is left in place by use of either a vacuum pump or by blowing out the tubing with air pressure. The antifreeze solution shall be contained and disposed of offsite in a proper manner by the Contractor.

E. METHOD OF MEASUREMENT

The number of settlement sensors, as provided in the plans, will be paid for at the contract unit price bid for "Monitoring Device - Settlement Sensors" which shall include all equipment, including but not limited to the settlement sensor, liquid reservoir, water proof casing; mobilization; labor; surveys; materials; incidentals and abandonment required by these Specifications.

F. BASIS OF PAYMENT

The price and payment for this work shall be full compensation for furnishing the necessary Settlement Sensor, including the settlement sensor, the liquid reservoir, the waterproof casing, surveys and incidental items based on the acceptance of the Settlement Sensor installation by the Engineer.

Payments shall be made under:

Item No.	Pay Item	Pay Unit
2038115	MON. DEVICE – SETTLEMENT SENSOR	EA

EXHIBIT 5 – SPECIAL PROVISIONS AND CONTRACT REQUIREMENTS

Model 4650 Settlement System



● Model 4650 Settlement System.

Applications

The Model 4650 is designed for remote measurement of the settlement of a point in or below fills, surcharges, embankments, etc. Systems with tube lengths of up to 300 m have been used successfully to measure settlements in earth dam embankments.

Operating Principle

A vibrating wire pressure sensor is attached to a settlement plate located at the point of settlement. The sensor is connected via two liquid-filled tubes, extending laterally, to a reservoir located on stable ground. The sensor measures the hydraulic head of liquid between the sensor and reservoir locations.

Advantages and Limitations

A vented cable runs from the sensor to the remote readout location and connects to the reservoir so that barometric pressure fluctuations do not affect the readings.

The liquid-filled tubes can be flushed to remove any air bubbles that might form.

It is possible to perform in-situ checks at any time on both the calibration and zero stability.

Technical Specifications

Standard Ranges ¹	7, 17 m (20, 50 ft.)
Resolution/Sensitivity	2, 4 mm (0.08, 0.16 in.)
System Accuracy ²	±4 to ±6 mm (±0.16 to ±0.24 in.)
Temperature Range ¹	-20°C to +80°C

¹Other ranges available on request.
²Sensor accuracy 0.1% F.S.

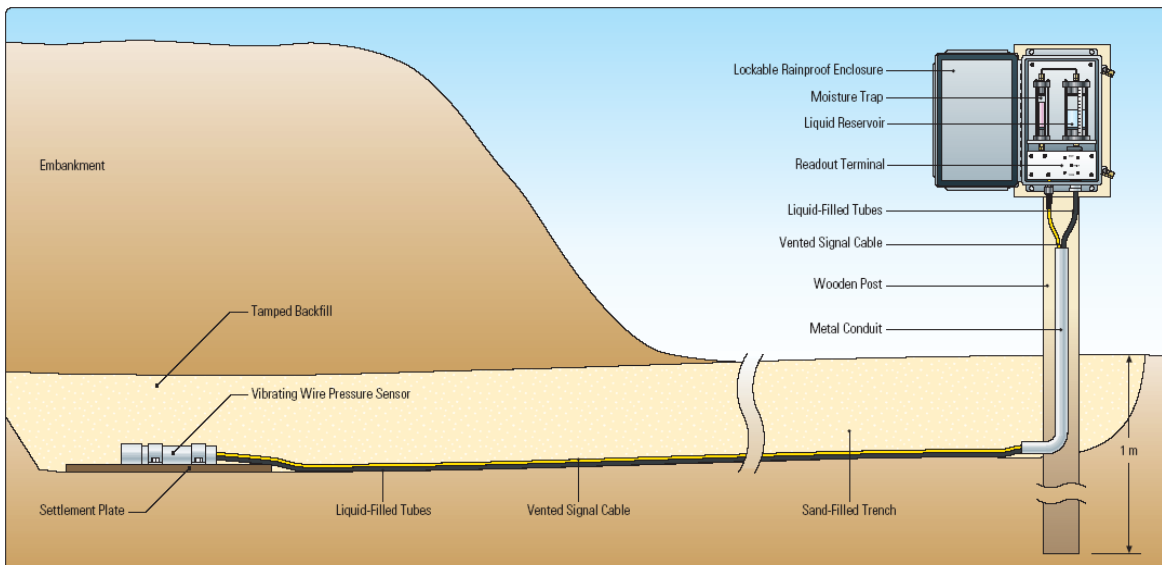

● Model 4650 installation for the remote measurement of subsurface settlement beneath a large embankment.

(39) SECTION 205: VIBRATING WIRE ROD EXTENSOMETER:

May 24, 2013

A. DESCRIPTION

This work includes furnishing all supervision, materials, equipment, labor, and related services necessary for providing, installing and maintaining a Vibrating Wire Rod Extensometer (VWRE) at the locations indicated in the plans and in accordance with these specifications. This item includes the furnishing of as-built drawings of actual locations where instrumentation was installed, survey data recorded during instrumentation installation, and installation field reports. Also included in this item of work is the initial and periodic/continuous recording of VWRE readings and reporting to the Engineer in accordance with the Department's Geotechnical Instrumentation Monitoring Plan for the entire duration of the project.

The purpose of the instrumentation monitoring program is to monitor settlement of the approach embankments.

The Contractor shall be familiar with project geotechnical conditions and recognize that geotechnical data is available with geotechnical boring logs, laboratory testing results, and other pertinent information.

B. VIBRATING WIRE ROD EXTENSOMETER

The Vibrating Wire Rod Extensometer is an automated device for monitoring settlement. The VWRE shall contain 6 rod extensometers that will measure settlement at different depths below the ground surface. The depths of data collection are indicated in the project plans. The rod extensometers will be housed in a casing of sufficient diameter to allow for 6 rods in each casing. The VWRE shall be capable of measuring settlements of 18 inches. The VWRE shall have an accuracy ± 0.1 percent with a thermal effect of < 0.05 percent for a temperature range of -4°F to 176°F . In addition, the VWRE shall have a long-term stability of < 0.2 percent per year. The location of each rod extensometer cluster is indicated in the project plans. Each rod extensometer cluster will be connected to a data collection center. The cluster shall be installed in accordance with the manufacturer's recommendations. Each VWRE cluster shall be connected to the data collection center either via cable or via cellular communications. If cable is used, enough cable shall be provided to run from the VWRE to the location of the Vibrating Wire Data Collection Center (VW-DCC) plus 10 feet for each instrument. The cable used to connect the VWRE to the VW-DCC shall meet the requirements of the instrument manufacturer/supplier. The Contractor shall supply non-conductive conduit to encase the cable between the VWRE and VW-DCC. The conduit shall have a minimal nominal diameter of 1 inch and meet the requirements of Schedule 80 materials. Provide enough conduit to enclose all lengths of buried cable from the VWRE to the VW-DCC. All connections in the conduit and in the cable between the VWRE and VW-DCC shall be water proof.

C. SUBMITTALS

Within 30 calendar days before installing the VWRE, the Contractor shall submit to the Department for review the personnel qualification, installation plan, and monitoring plan. The submittals shall contain as a minimum the following information.

1. Qualifications:

The Contractor shall identify the licensed surveyor who shall be responsible for providing survey services during the installation of the VWRE. The Contractor shall identify the geotechnical engineer that will be responsible for installing and maintaining the VWRE. The same geotechnical engineer that is responsible for the VW-DCC and piezometers will also be responsible for the VWRE. The geotechnical engineer's experience in installing VWRE in accordance with the plans and Contract Documents shall be documented by providing a project summary, of at least three projects, that includes for each project the project name, role in providing instrumentation services, type of VWRE, equipment used, duration of the project (i.e. dates), magnitude of settlements, client name and address, name and phone number of representative of the consultant and owner for whom the work was performed and can attest to the successful completion of the work, and any other information relevant to demonstrating the geotechnical engineer's qualifications. In addition, the manufacturer/supplier shall also be on-site during the initial installation of the VWRE to ascertain that all instruments have been connected

correctly. The manufacturer/supplier shall also be available for questions from either the geotechnical engineer responsible for maintaining the VWRE or from the Department concerning the data being collected.

2. Installation Plan:

The installation plan shall include as a minimum the following information:

- a. The Contractor shall submit the Specification sheet for the proposed VWRE system for review and approval by the Engineer.
- b. Submit locations where VWRE will be installed if different from the location shown on the plans.
- c. Proposed installation method
- d. Proposed method to protect VWRE during construction from construction equipment, vandalism, weather

3. Submittal Reviews:

Approval of the personnel qualification and installation plan by the Department shall not relieve the Contractor of its responsibility to successfully install the VWREs in accordance with the plans and specifications. Approval by the Department of the VWRE installation plan shall be contingent upon satisfactory demonstration that the VWRE is meeting the objectives of the Department's Geotechnical Instrumentation Monitoring Plan. If, at any time, the Department or the Engineer considers that the VWRE does not produce satisfactory results, the Contractor shall alter the method and/or equipment as necessary to comply with the Special Provisions and Department's Instrumentation Plan. The Department will be the sole judge in determining the adequacy of the Contractor's VWRE.

D. DELIVERY, STORAGE, AND HANDLING

The Contractor shall check all materials and equipment upon delivery to ensure that the proper items are received and are not damaged. All materials shall be stored and maintained in a clean, uncontaminated condition throughout the course of the project. Upon receipt of the VWRE, the Contractor shall submit copies of the manufacturer's installation and instruction manual for review and approval by the Engineer, and shall make available the data logging system for inspection by the Engineer.

E. VWRE INSTALLATION

Upon receipt of the VWRE, the Contractor shall submit copies of calibration sheets and the manufacturer's installation and instruction manual for review and approval by the Engineer, and shall make available the VWRE for inspection by the Engineer.

The Contractor shall notify the Engineer at least fourteen (14) days prior to the installation of VWRE. The VWREs shall be furnished and installed by the Contractor in accordance with the plans and this specification and in the presence of the Engineer.

The Contractor shall be responsible for locating all VWREs in the field and ensuring that no conflicts exist between VWREs and foundations, structures, utilities or other construction proposed or present at the site.

The Contractor shall provide a licensed surveyor to stake out and provide as-built locations and elevations of all VWREs locations.

VWREs shall be installed prior to construction of the embankment. VWRE installation shall be in accordance with the manufacturer's recommendations as presented in their instruction and installation manual. The VWRE will be connected to the VW-DCC in accordance with the plans, contract documents, and manufacturer's recommendations.

EXHIBIT 5 – SPECIAL PROVISIONS AND CONTRACT REQUIREMENTS

The Contractor shall accurately locate all VWREs in accordance with the plans. VWREs may be adjusted by the Contractor, with the approval of the Engineer, to avoid utilities, foundations, and all other underground construction.

Within 1 week following installation, the contractor shall submit an installation record for each VWRE, which includes the instrumentation identification as provided in the plans, station/alignment, offset, and elevation. The VWRE shall be located to an accuracy of 0.01 ft (both vertically and horizontally).

The Contractor shall protect VWRE locations from damage and vandalism for the duration of the Contract and repair or replace damaged or inoperative VWREs at no cost to the Department.

F. ABANDONMENT OF VWRE

Once the Engineer has determined that the VWRE systems have served their purpose and are no longer needed, the VWRE systems shall be abandoned in-place. The Contractor shall remove recoverable portions of the VWRE. All recoverable instrumentation shall remain property of the Contractor. The Contractor shall remove no more than 2 feet of the conduit that extends into the embankment and shall seal the conduit left in place within the embankment using a lean grout mix.

G. METHOD OF MEASUREMENT

The number of VWRE provided in the plans, will be paid for at the contract unit price bid for "Vibrating Wire Rod Extensometer" which shall include all equipment, including but not limited to the VWRE, water proof casing; mobilization; labor; surveys; materials; incidentals and abandonment required by these Specifications along with VWRE data as outlined in the Geotechnical Instrumentation and Monitoring Plan. Payment will not be made for VWRE that malfunction or are rejected for their inability to perform, or do not meet the requirements in the plans and these specifications.

H. BASIS OF PAYMENT

The price and payment for this work shall be full compensation for furnishing the necessary data logging system, enclosure, protection from vandalism and construction equipment, data as outlined in the Geotechnical Instrumentation and Monitoring Plan, and incidental items based on the successful implementation of the VWRE system.

Payments shall be made under:

Item No.	Pay Item	Pay Unit
2038140	MON. DEVICE – VIBRATING WIRE ROD EXTENSOMETERS	EA

(40) SECTION 205: VIBRATING WIRE DATA COLLECTION CENTERS:

May 24, 2013

A. DESCRIPTION

This work includes furnishing all supervision, materials, equipment, and labor, and related services necessary for providing and maintaining a Vibrating Wire Data Collection Center (VW-DCC) at the locations indicated in the plans and in accordance with these specifications. This work consists of automating the data collection for vibrating wire rod extensometers (RE), total pressure cells (TPC), and piezometers (PZ) with a real-time system that is accessible via the internet in accordance with the Department's Geotechnical Instrumentation Monitoring Plan for the entire duration of the project as determined necessary for evaluating the settlement and pressure instrumentation of the embankments being constructed.

B. VIBRATING WIRE DATA COLLECTION CENTER

The Vibrating Wire Data Collection Center (VW-DCC) is an automated centralized vibrating wire data collection center. The VW-DCC will be used to collect VWRE, TPC and PZ readings. Temperature readings shall also be collected when instrumentation contains thermistors. The automated collection of VW data shall be accomplished by using a data logging system that is sufficiently capable to monitor the VW sensors indicated in the plans and with the capability of adding four additional rod extensometers and six piezometers to the system. Sufficient ports shall be provided to also monitor temperature. The reserve instrumentation monitoring capacity can be either achieved by using a data logging system with sufficient ports or by having the capability to expand the system if needed. The Contractor shall maintain compatibility between the data logging system and the rod extensometers, total pressure cells, and piezometer instrumentation. In order to maintain compatibility of the systems and be able to get technical assistance from the manufacturer during installation and throughout the project, the VW-DCC system should be supplied / manufactured by the same company that is supplying the VWRE, TPC, and PZ instrumentation. In addition, the VW-DCC shall have the following features:

1. Data logging system with sufficient capacity to read and save instrumentation readings
2. The data logging system shall have the reserve capacity to add additional instrumentation if needed
3. Powered by on-site AC current
4. Battery power back-up with surge suppression
5. Telephone/cellular access for transmitting data through the internet
6. Dedicated server for storing and running viewing software
7. On-line instrumentation software for reviewing/downloading instrumentation data
8. Enclosure that protects the equipment from damage during construction, vandalism, and weather

Data collected via the VW-DCC shall be provided to the Department in the format outlined in the Geotechnical Instrumentation and Monitoring Plan.

C. SUBMITTALS

Within 30 calendar days before installing the VW-DCC, the Contractor shall submit to the Department for review the personnel qualification, installation plan, and monitoring plan. The submittals shall contain as a minimum the following information.

1. Qualifications:

The Contractor shall identify the geotechnical engineer that will be responsible for installing and maintaining the VW Data Collection Center. The same geotechnical engineer that is responsible for the vibrating wire REs, TPCs, and PZs will also be responsible for the VW-DCC. The geotechnical engineer's experience in providing automated data logging capabilities such as the VW-DCC in accordance with the plans and contract documents shall be documented by providing a project summary, of at least three projects, that includes for each project the project name, role in providing instrumentation services, type of data logging system, equipment used, duration of the project (i.e. dates), client name and address, name and phone number of representative of the consultant and owner for whom the work was performed and can attest to the successful completion of the work, and any other information relevant to demonstrating the geotechnical engineer's qualifications. In addition, the manufacturer/supplier shall also be on-site during the initial installation of the VW-DCC to ascertain that all instruments have been connected correctly. The manufacturer/supplier shall also be available for questions from either the geotechnical engineer responsible for maintaining the VW-DCC or from the Department concerning the data being collected.

2. Installation Plan:

- a. The installation plan shall include as a minimum the following information:
- b. The Contractor shall submit the Specification sheet for the proposed VW-DCC system for review and approval by the Engineer
- c. Submit locations where VW-DCC will be installed
- d. Proposed installation method
- e. Proposed method to protect VW-DCC during construction from construction equipment, vandalism, weather

3. Submittal Reviews:

Approval of the personnel qualification and installation plan by the Department shall not relieve the Contractor of its responsibility to successfully install the VW REs, TPCs, and PZs and monitor this instrumentation with VW-DCC in accordance with the plans and specifications. Approval by the Department of the VW-DCC installation plan shall be contingent upon satisfactory demonstration that the VW-DCC is meeting the objectives of the Department's Geotechnical Instrumentation Monitoring Plan. If, at any time, the Department or the Engineer considers that the VW-DCC does not produce satisfactory results, the Contractor shall alter the method and/or equipment as necessary to comply with the Special Provisions and Department's Instrumentation Plan. The Department will be the sole judge in determining the adequacy of the Contractor's VW-DCC.

D. DELIVERY, STORAGE, AND HANDLING

The Contractor shall check all materials and equipment upon delivery to ensure that the proper items are received and are not damaged. All materials shall be stored and maintained in a clean, uncontaminated condition throughout the course of the project. Upon receipt of the VW-DCC, the Contractor shall submit copies of the manufacturer's installation and instruction manual for review and approval by the Engineer, and shall make available the data logging system for inspection by the Engineer.

E. ABANDONMENT OF VW-DCC

Once the Engineer has determined that VW-DCC systems have served their purpose and are no longer needed, the VW-DCC shall be abandoned by removing all equipment and signal wires a minimum of 2 feet of ground surface.

F. METHOD OF MEASUREMENT

The number of VW-DCC provided in the plans, will be paid for at the contract unit price bid for "Vibrating Wire Data Collection Center" which shall include, but not limited to, all labor, materials, and equipment necessary to install a vibrating wire data collection center along with data as outlined in the Geotechnical Instrumentation and Monitoring Plan. Payment will not be made for VW-DCC that malfunction or are rejected for their inability to perform, or do not meet the requirements in the plans and these specifications.

G. BASIS OF PAYMENT

The price and payment for this work shall be full compensation for furnishing the necessary data logging system, enclosure, protection from vandalism and construction equipment, data as outlined in the Geotechnical Instrumentation and Monitoring Plan, and incidental items based on the successful implementation of the VW-DCC system.

Payments shall be made under:

EXHIBIT 5 – SPECIAL PROVISIONS AND CONTRACT REQUIREMENTS

Item No.	Pay Item	Pay Unit
8990440	VW DATA COLLECTION CENTER	EA

(41) SECTION 205: VIBRO COMPACTION:

June 27, 2013

A. DESCRIPTION

This section presents administrative and procedural requirements for ground modification by Vibro-Compaction (VC). Vibro-compaction shall be implemented in and below the existing embankment fill material of both the beginning of bridge approach embankment and the end of bridge approach embankment. VC shall be provided as documented in the plans. The purpose of the vibro-compaction program is to densify the granular soils at the specified locations and depths to mitigate liquefaction potential.

The Contractor shall perform layouts and measurements for VC work. VC points may be surveyed in or located by measuring offsets from surveyed points (e.g., project stations) using a tape measure.

The Contractor shall notify the Engineer a minimum of 48 hours prior to commencement of the VC operations at each approach embankment location.

Any change in the predetermined VC program necessitated by a change in the field conditions shall be immediately reported and submitted to the Geotechnical Engineer. Upon completion of the work, the Contractor shall submit a drawing of as-built locations of vibro-compacted columns.

B. REFERENCES

The Geotechnical Engineer will coordinate all testing to determine compliance with the project design.

1. Applicable Standards: The most recent version of the following testing methods or standards shall be employed:
 - a. ASTM D1586 "Standard Test Method for Standard Penetration Test (SPT) and Split-Barrel Sampling of Soils"
 - b. ASTM D5778 "Standard Test Method for Electronic Friction Cone and Piezocone Penetration Testing of Soils" (CPT)
 - c. ASTM D6635 "Standard Test Method for Performing the Flat Plate Dilatometer" (DMT)

2. Reference Documents: Reference documents to be used by the Contractor shall include:
 - a. This specification
 - b. Attached plans
 - c. Project geotechnical report prepared by the Geotechnical Engineer.

Prior to commencing work, the contractor shall examine the site, drawings, records of existing utilities and other existing subsurface structures, and soil test boring logs made available in the original bid documents and those performed by the Geotechnical Engineer to help determine VC installation conditions.

C. SUBMITTALS

This section details all submittals required prior to field work, at completion of the test section, during production work, and after the work is completed.

EXHIBIT 5 – SPECIAL PROVISIONS AND CONTRACT REQUIREMENTS

1. Pre-Field Work Submittals: The following shall be submitted to the SCDOT by the Geotechnical Engineer prior to the start of the work. VC operations may not commence until approval by the SCDOT is granted.
 - a. A Work Plan prepared by the Contractor for the production work outlining the anticipated spacing, location and depth to achieve the project design criteria.
 - b. Drawing(s) for review, indicating the spacing, location, and depth of the VC probes to achieve the project design criteria.
2. Post Test Section and Pre Production Work:
 - a. Results of the test section evaluation.
 - b. A revised work plan and VC layout should the test section results require a modification to the original work and production plans.
3. During Production Submittals: The following shall be submitted to the SCDOT by the Geotechnical Engineer during the work:
 - a. Any change in the predetermined VC program necessitated by a change in the field conditions.
4. Closeout Submittal: The following shall be submitted to the SCDOT by the Geotechnical Engineer within 14 days of the completion of the VC work.
 - a. As built drawings: Drawings documenting any significant changes to the shop drawing. If no changes are noted, then no as-built drawings are necessary following completion of the VC program.

D. EQUIPMENT AND MATERIALS

The Contractor shall supply equipment in good operating condition capable of performing the work specified herein. The Contractor shall use equipment capable of efficiently accomplishing the required soil densification. The probe shall have durable markings on one foot intervals allowing a visual determination of the depth of penetration when in use. The probe shall be of sufficient length to extend a minimum depth of thirty (30) feet below existing grade.

The VC procedure is not intended to be a 'wet' operation. Water shall be used sparingly to mitigate clogging of the VC equipment.

Settlement resulting from the VC operations is anticipated. Any required fill placement in the resulting deformations required to meet the design grade(s) shall meet the requirements outlined in the *Special Provision 40 – Section 203: Borrow Excavation* provided in the bid documents.

Groundwater is anticipated to emerge to the ground surface during VC operations. The Contractor shall implement Best Management Practices (BMP's) to efficiently control surface groundwater runoff in accordance with the contract documents.

E. CONSTRUCTION

Production VC criteria shall be as follows:

1. Depth of treatment: The probe tip shall penetrate to the minimum elevation specified in the above referenced documents and submittals.
2. Locations/Spacing: The center to center probe spacing shall adhere to the requirements in the above referenced documents and submittals. Probes shall be performed within 12 inches of the planned location
3. Limits of work: The limits of the VC work are shown on the drawings described in the above referenced documents and submittals.

F. QUALITY CONTROL

The details of the quality control program are as follows:

1. Technical Oversight: All VC operations shall be performed under the inspection of the Geotechnical Engineer's representative.
2. Monitoring and Logging: Monitoring and logging of all VC operations for the test area and production work shall be done by the Contractor.
3. Test Section: The Geotechnical Engineer's representative shall monitor the performance of the test section and perform the testing indicated below:
 - a. A test section shall be performed before production work, as follows:
 - 1) The test section location shall be agreed upon by the Geotechnical Engineer and the Contractor within the treatment area. The test section will consist of a minimum of twelve (12) VC points in three (3) rows of four (4) points each. For preliminary design considerations, the vibro-densification program will utilize a five (5) foot triangular grid for the indicated treatment area(s).
 - 2) The method of installation, materials, equipment, and procedures shall be the same as those to be used for production work.
 - 3) Based on the results from the test section, modifications to the Work Plan may be implemented, as needed, to meet the project design. Any changes to the Work Plan will be submitted to the SCDOT following completion of the test program.
 - b. The Geotechnical Engineer shall coordinate the following tests of the test section after a minimum wait period of four (4) days from completion of the VC activities of the test program: One (1) CPT (*or* SPT) test performed at the center of a VC probe location, and one (1) CPT (*or* SPT) test performed at the midpoint of adjacent VC probe locations.
 - c. The primary method for determining the post-treatment soil strength parameters for production VC work will be from the phi angle correlations in Chapter 7 of the SCDOT Geotechnical Design Manual. These equations are based on either the blow counts as determined from the SPT test, the cone tip resistance as determined from the CPT test, or the horizontal stress index as determined from the DMT test.
 - d. The production VC criteria will be based on a minimum applied relative energy for a given time rate. Following completion of the test program, the Geotechnical Engineer will establish criteria for the production VC work.
4. Daily Records: Monitoring and logging of VC operations for the test area and production work shall be performed by the Contractor. At a minimum, the following information shall be collected for each VC probe location:
 - a. Equipment details and specifications
 - b. Embankment location
 - c. Probe ID (i.e. A-27)
 - d. Start and finish time
 - e. Maximum recorded energy reading
 - f. Depth of treatment
 - g. Comments or unusual observationsA sample monitoring log for the VC work is provided with this specification.
5. Monitoring of Existing Structures: There are no structures within 500 feet of the planned VC work, and, therefore, a vibration monitoring program is not required for the VC work

6. The Contractor shall ensure that procedures and documentation conform to these specifications.

G. METHOD OF MEASUREMENT

The acceptance of the VC work shall be solely based on the results from the pre-treatment test program outlined in this specification. The Geotechnical Engineer shall provide to the SCDOT a signed and sealed statement that the soil improvement conforms to requirements of the project design.

H. RESTRICTIONS

The Contractor shall be responsible for obtaining the necessary State and municipal permits for the intended construction. The Contractor shall be responsible for the precise delineation of all above and below ground utilities and obstructions and shall accurately mark their layout at the site. The following shall also be listed within this section when applicable:

1. Environmental restrictions
2. Work boundaries
3. Hours and days available for construction

(42) SECTION 205: DEEP SOIL MIXING (DSM):

September 22, 2011

A. DESCRIPTION

This work shall consist of using deep soil mixing (DSM) construction techniques (also known as deep mixing methods, DMM) to improve weak subsurface soils by mixing a binder material with in-situ soil to produce a DSM column composed of a soil-binder mixture that has increased compressive strength and stiffness properties compared to the original in-situ soil properties. A column is defined as the extent that the existing ground is improved by insertion and removal of the mixing tool to the full improvement depth required in the plans. DSM column mixing methods allowed are described in subsection A.1 and DSM column spacing requirements are described in subsection A.2. The purpose for constructing DSM columns is to improve weak subsurface soils in order to stabilize and/or improve performance of existing ground prior to constructing bridge foundations, embankments, mechanically stabilized earth (MSE) walls, retaining walls, and other transportation structures or facilities as specified herein and shown on the plans and contract documents. References listed in subsection A.3 may be used in these special provisions and will be used to evaluate this work.

The work covered by this specification includes furnishing all necessary plant, labor, equipment, geotechnical subsurface investigation, pre-production laboratory testing, test section(s), surcharges/berms constructed at the DSM improved locations (if shown in the plans or required to meet DSM column performance requirements), in-situ testing, sampling/coring, QA/QC testing, reporting, and other work described below. The Contractor shall be familiar with project geotechnical conditions and recognize that geotechnical data is available with geotechnical boring logs, laboratory testing results, and other pertinent information.

1. DSM Mixing Methods:

This special provision contains specifications for construction of DSM columns by either the wet or dry mechanical mixing method. The Contractor shall use the DSM mechanical mixing method specified in the plans unless other methods are approved in writing by the Engineer. DSM column mixing method for the wet and dry mixing methods are defined as follows:

- a. **Wet Method:** The wet method consist of mixing a binder in slurry form (i.e. cement grout) with existing soils using auger-type equipment (paddles, augers, and other rigid mixing tools), without use of externally directed high pressure jets, to form a DSM column

consisting of a homogeneous mixture of cement grout and in-situ soils. The wet mixing method typically produces spoils in the range of 10 to 60 percent of the treated volume. A soil-cement column formed by the wet mixing method is abbreviated herein as DSM-SCC).

- b. **Dry Method:** The dry method consists of mixing dry binders (i.e. lime-cement or cement) into the in-situ soils. The dry binder is injected into the soil by using air pressure. The mixing tool blends the binder material with the in-situ soil and water to form a DSM column of a homogeneous mixture of binder materials and in-situ soils. The dry mixing method typically produces spoils less than 10 percent of the treated volume. A DSM column (lime-cement or cement) formed by the dry mixing method is abbreviated herein as DSM-LCC.

2. DSM Column Spacing:

The DSM columns shall be spaced and arranged as indicated on the plans or as otherwise directed by the Engineer. DSM columns can be constructed by using group column spacing or by using block column spacing as described below:

- a. **Group Column Spacing (GCS):** DSM group column spacing (GCS) consists of constructing a single column (no overlap with adjacent DSM columns) with a diameter of 20 to 36 inches or as required in the plans. The DSM columns group spacing is defined in the plans by specifying a pattern (i.e. triangular, grid, etc.) and center-to-center spacing between DSM columns.
- b. **Block Column Spacing (BCS):** DSM block columns spacing (BCS) consists of constructing an improved soil zone with DSM columns overlapping adjacent DSM columns. Since the improved soil zone is continuous, the size of the DSM column is not specified in the plans to accommodate variations in the Contractor's equipment dimensions. As a result of Contractor equipment variations in size, any variations in the dimensions of the zone of ground improvement shown in the plans will require written approval by the Engineer. The center-to-center spacing shall be determined by the Contractor based on the DSM construction equipment in order to provide continuous overlapped DSM columns in accordance with the plans and specifications. Continuous column spacing may be achieved by the use of DSM equipment capable of constructing multiple columns simultaneously. The DSM column overlap distance between adjacent DSM columns shall be a minimum of 20 percent of the DSM column diameter or as approved by the Engineer. The DSM column center-to-center spacing between adjacent columns shall be defined as the DSM column diameter minus the column overlap distance.

3. References:

The evaluation of this work, including the DSM Installation Plan, test section(s), QC testing, and QA testing will be based on, but not limited to, the following references:

- a. Bruce, D.A. (2000). "An Introduction to the Deep Soil Mixing Methods as Used in Geotechnical Applications, Volume I," FHWA-RD-99-138.
- b. Bruce, D.A. (2000). "An Introduction to the Deep Soil Mixing Methods as Used in Geotechnical Applications, Volume II: Appendices," FHWA-RD-99-149.
- c. Bruce, D.A. (2001). "An Introduction to the Deep Mixing Methods as Used in Geotechnical Applications, Volume III: The Verification and Properties of treated Ground," FHWA-RD-99-167.
- d. Elias, V., Welsh, J., Warren, J., Lukas, R., Collin, J.G., and Berg, R.R., (2006). "Ground Improvement Methods," Volumes I and II, FHWA NHI-06-019 and FHWA NHI-06-020, US Dept. of Transportation, Federal Highway Administration.
- e. Filz, G. M., Hodges, D. E., Weatherby, D. E., and Marr, W. A. (2005). "Standardized Definitions and Laboratory Procedures for Soil-Cement Specimens Applicable to the Wet

Method of Deep Mixing." *Innovations in Grouting and Soil Improvement*, Reston, Virginia, 13.

- f. Filz, G. M. and Stewart, M. E. (2005). "Design of Bridging Layers in Geosynthetic-Reinforced, Column-Supported Embankments." Virginia Transportation Research Council, Charlottesville, VA
- g. Jacobson, J. R., Filz, G. M., and Mitchell, J. K. (2003). "Factors Affecting Strength Gain in Lime-Cement Columns and Development of a Laboratory Testing Procedure," Report prepared for the Virginia Transportation Research Council, Virginia Polytechnic Institute and State University, Report No. 57565, FHWA/VTRC 03-CR16.
- h. Jacobson, J. R., Filz, G. M., and Mitchell, J. K. (2005). "Factors Affecting Strength of Lime-Cement Columns Based on a Laboratory Study of Three Organic Soils." Deep Mixing'05: International conference on deep mixing best practice and recent advances.
- i. Larsson, S. (2005a). "State of Practice Report – Execution, monitoring and quality control," Volume 2, Deep Mixing '05: International Conference on Deep Mixing Best Practice and Recent Advances.
- j. Larsson, S. (2005b). "On the use of CPT for quality assessment of lime-cement columns." Deep Mixing '05: International Conference on Deep Mixing Best Practice and Recent Advances.
- k. McGinn, A. J. and O'Rourke, T. D. (2003). "Performance of deep mixing methods at Fort Point Channel." Cornell University.

B. MATERIALS

1. Wet Method (DSM-SCC):

Cement: Portland cement shall be low alkali Type II conforming to Section 701.2.1 and ASTM C150. Slag cement shall conform to Section 701.2.3 and ASTM C 989. All cement shall be homogeneous in composition and properties, and shall be manufactured using the same methods at one plant by one supplier. Tricalcium aluminate content shall not exceed 7 percent.

Water: Water shall conform to the requirements of Section 701.2.11.

Admixtures: Cement admixtures will not be allowed without written approval by the Engineer. Cement admixtures are ingredients that are used to permit efficient use of materials and proper workability of the binder material being mixed into the in-situ soils. The Contractor is required to submit any proposed admixtures and their intended effect when the binder mix design is submitted for approval by the Engineer.

Cement Grout: The cement grout shall be a stable homogeneous mixture of cement, admixtures (if approved), and water in proportions determined by the results of the test section and approved by the Engineer. The cement grout is mixed with the in-situ soils to form DSM-SCC columns.

Soil-Cement Mixture: The DSM column shall be composed of a stable and uniform soil-cement mixture of cement grout and in-situ soil that meets the project compressive strength and other requirements in the plans and these special provisions. The proposed ratios of concrete grout to in-situ soils and quantities of various components shall be determined by the results of the test section and approved by the Engineer.

2. Dry Method (DSM-LCC):

Cement: Portland cement shall be low alkali Type II conforming to Section 701.2.1 and ASTM C150. Slag cement shall conform to Section 701.2.3 and ASTM C 989. All cement shall be homogeneous in composition and properties, and shall be manufactured using the

same methods at one plant by one supplier. Tricalcium aluminate content shall not exceed 7 percent.

Quick Lime: Quick lime shall have at least 99 percent passing the #8 sieve (3.18 mm) and at least 90 percent passing a No. 12 Sieve (2.12 mm), an active CaO content greater than 80% and a floatability of 70.

Premixed Lime-Cement: If a premixed quick lime and cement is to be used, the manufacturer of the mixture must certify that the proportions of lime and cement provided are in accordance with the design requirements developed from the test section and approved by the Engineer.

Admixtures: Cement admixtures will not be allowed without written approval by the Engineer. Cement admixtures are ingredients that are used to permit efficient use of materials and proper workability of the binder material being mixed into the in-situ soils. The Contractor is required to submit any proposed admixtures and their intended effect when the binder mix design is submitted for approval by the Engineer.

Binder: The binder will be a stable homogeneous mixture of cement, lime (if applicable), and admixtures (if approved), in proportions determined by the results of the test section and approved by the Engineer. The binder material is delivered using air pressure and is mixed with the in-situ soils to form DSM-LCC columns.

Soil-Binder Mixture: The DSM column will be composed of a stable and uniform soil-binder mixture that meets the project design requirements and these special provisions. The proposed ratios of binder material to in-situ soils and quantities of various components shall be determined by the results of the test section and approved by the Engineer.

C. SUBMITTALS

A minimum of 45 calendar days prior to beginning the DSM work, the Contractor shall submit a DSM Construction Plan and Shop Plans/Working Drawings for review and approval by the Engineer. The DSM Construction Plan and Shop Plans/Working Drawings shall be prepared, signed, and sealed by an agent/representative of the DSM Contractor that is a professional engineer licensed in the State of South Carolina. The Contractor shall not commence DSM installation without the approval of all submittals by the Engineer. Approval by the Engineer will not relieve the Contractor of its responsibilities to provide materials and equipment necessary to install DSM columns in accordance with the plans and specifications. If, at any time, the Engineer considers that the Contractor's installation operation does not produce a satisfactory DSM column, the Contractor shall alter its method and/or equipment as necessary to comply with the plans and specifications at no additional cost to the Department.

The Contractor shall submit 8 sets of the DSM Construction Plan and 8 sets of Shop Plans/Working Drawings to the Preconstruction Support Engineer (PSE) for review in accordance with the requirements provided herein. Send DSM Construction Plan and Shop Plans/Working Drawings for projects designed for the Department by a design consultant directly to the consultant. For DSM Construction Plan and Shop Plans/Working Drawings sent to the PSE, send a copy of the transmittal letter to the BCE, the OMR, and the RCE. For Shop Plans sent directly to a design consultant, send a copy of the transmittal letter to the PSE, the BCE, the OMR, and the RCE. Obtain the necessary mailing information at the Preconstruction Conference.

1. DSM Construction Plan:

The DSM Construction Plan shall document and provide, as a minimum, the following information:

EXHIBIT 5 – SPECIAL PROVISIONS AND CONTRACT REQUIREMENTS

a. *Qualifications:* Evidence of six years of accumulated experience over a period of 10 years and competence to construct the required DSM columns by the mixing method (i.e. wet or dry) required for the project shall be submitted. As a minimum, the Contractor shall submit a detailed description of three DSM projects completed using the required mixing method within the previous six years that demonstrate the Contractor's experience and competence. Jet grouting or penetration grouting projects will not be acceptable as representative of DSM construction techniques. Each DSM project submitted as proof of experience and competence shall have a minimum total treatment volume of not less than 20 percent of the DSM treatment volume for this project or 30,000 cubic yards of DSM treatment volume, whichever is greater, in high plasticity clay, sand, and silt. At least two of the submitted DSM projects using the required mixing method shall have average treatment depths greater than 60 feet. Each DSM project submitted shall have the following information:

- 1) Project name, location, and completion date
- 2) Current contact information (address, phone number, and email) of project owner, designer, geotechnical consultant, and contract manager
- 3) Surface and subsurface conditions, and strength (average, ranges, and means used to determine strength) of DSM columns installed
- 4) Minimum, maximum, and average rates of DSM installation
- 5) Project cost and duration of DSM installation
- 6) Average depths and ranges of depths of DSM columns installed. Provide total linear footage and volume (cubic yards) of DSM columns installed
- 7) Percent of project total based on QA/QC testing that met the project Acceptance Criteria and percent of project total based on QA/QC testing that required remediation techniques after initial DSM installation

The Contractor shall also submit a list of completed ground improvement projects where they performed DSM column construction techniques over the past six years that includes items "a" and "e" listed above, type of DSM mixing, and DSM quantity constructed (similar to item "f" above).

The Contractor's proposed DSM superintendent shall have a minimum of three years of accumulated experience with DSM construction equipment and construction management within the past six years. The DSM superintendent shall have been employed by the Contractor for the most recent three years. The proposed DSM superintendent shall have been superintendent for the Contractor on at least one of the three DSM projects submitted by the Contractor as evidence of their experience. Experience and training records shall be submitted for proposed DSM superintendent and operators of construction equipment. Any changes in DSM construction personnel shall require submittal of qualifications for approval.

The Independent Testing Laboratory shall have at least 5-years' experience as a materials testing laboratory, including the performance of testing comparable to that required herein. The person in charge of the testing work for the Independent Testing Firm shall be a Professional Civil Engineer, registered in the State of South Carolina. The Independent Testing Laboratory's supervisor and each field representative who will take samples in the field shall have at least 5-years' experience in taking concrete samples in the field and performing compressive strength tests in accordance with AASHTO requirements, and be accredited as required by SCDOT to obtain and form concrete test cylinders. The persons who will perform laboratory testing shall have at least 2-years' experience in performing the soil tests required herein.

- b. *Protection of Utilities:* Location of all subsurface utilities in the area and the plan to protect them in place if the utilities are not being relocated out of the affected area.
- c. *Construction Schedule:* A construction schedule for the DSM work identifying start dates and durations for all portions of the work, including equipment mobilization, equipment

EXHIBIT 5 – SPECIAL PROVISIONS AND CONTRACT REQUIREMENTS

setup, test section(s) construction, production DSM construction at each location, and QC testing.

- d. *DSM Mixing Method*: Provide the type of mixing method (Wet or Dry) that will be used in accordance with the plan documents to construct the DSM columns in accordance with the plans and these specifications.
- e. *Equipment and Procedures*: A detailed description of the equipment (include catalog cut sheets of equipment dimensions) and procedures to be used during all facets of the project including, but not limited to the conduct of the following:
 - 1) Test section(s)
 - 2) Site preparation
 - 3) Stage construction of DSM test section(s) and production DSM (if required)
 - 4) Locating the DSM columns in the field
 - 5) DSM spoil containment, handling, and disposal
 - 6) Confirming method to check that the DSM are installed plumb
 - 7) Quality control program
 - 8) Monitoring quality control parameters
 - 9) Sample collecting for laboratory confirmation testing
- f. *DSM Test Section Subsurface Information and Location*: Submit the probe testing results used to pre-approve the location of the test section(s). Provide a minimum of two probe test at each test section in accordance with Section H.2 for review and approval by the Engineer of the proposed location of the test section(s). Pre-approval of the test section location(s) shall be required before commencing Pre-production field and laboratory testing (Section D). Probe testing shall be conducted to the production DSM depths plus 10 feet that the test section represents. Indicate on a plan drawing the location of the test section(s), dimensions and layout of the test section(s), number of DSM columns (include designation of each DSM column), and location of probe testing performed (Section H.2). This information should be included in this submittal even if submitted previously during pre-approval of DSM test section location(s).
- g. *Pre-Production DSM Binder Mix Design Report*: Final report of pre-production laboratory and field testing used to develop proposed wet or dry binder mix design for the construction of the test section(s). The pre-production laboratory and field testing shall conform to Section D of this special provision.
- h. *Cement and Cement Grout Mix Design (Wet Mixing Method, DSM-SCC)*: Proposed cement and cement grout mix design when DSM columns are constructed using the wet mixing method (DSM-SCC). The design shall include the following:
 - 1) Cement type and Cement manufacturer's certificate of compliance.
 - 2) Cement grout water-cement ratio, by weight. Include details to fully describe and illustrate the methods for grout proportioning to achieve the design mix.
 - 3) Cement Factor (also known as Residual Cement Factor) which is the amount of cement, dry weight in pounds, that remains in the ground after mixing, per cubic yard of in-situ soil-cement.

These mix design parameters will be reviewed based on the pre-production field and laboratory testing results developed in accordance with Section D. The acceptance of the proposed grout mix/soil/cement mix design shall be contingent on the test section(s) results meeting the acceptance criteria of Section K. The Contractor may propose to expand the size of the test section to demonstrate that somewhat different grout water/cement ratio and/or cement factor is workable in achieving the required soil-cement strength under actual in-situ conditions. Provide documentation of calibration of the mixing plant.

- i. *Binder Mix Design (Dry Mixing Method, DSM-LCC)*: Proposed binder mix design(s) when DSM columns are constructed using the dry mixing method (DSM-LCC). Binder mix

EXHIBIT 5 – SPECIAL PROVISIONS AND CONTRACT REQUIREMENTS

design shall include all materials, quantities, and dosages required to achieve the Acceptance Criteria (Section K). The design shall include the following:

- 1) Cement type and Cement manufacturer's certificate of compliance
- 2) Quick lime (if used) manufacturer's certificate of compliance
- 3) Pre-mixed lime-cement (if used) manufacturer's certificate of compliance
- 4) Binder mix dosage of each material in the binder mix per volume
- 5) Proportion of binder material to soil in the soil-binder mixture

These mix design parameters will be reviewed based on the pre-production field and laboratory testing results developed in accordance with section D. The acceptance of the proposed binder and soil/binder mix design shall be contingent on the test section(s) results meeting the acceptance criteria of section K. The Contractor may propose to expand the size of the test section to demonstrate that somewhat different binder mix design is workable in achieving the required soil-binder strength under actual in-situ conditions. Provide documentation of calibration of the mixing plant.

- j. *Independent Laboratory Testing*: Identification of all independent AASHTO certified materials laboratory testing facilities that will be used on the project and the type laboratory testing that will be conducted at each laboratory. All laboratory testing shall be performed at a materials laboratory with current AASHTO certification for the type of test being conducted. A single independent AASHTO certified materials testing laboratory shall be used to conduct all of the compressive strength testing that will be performed on the project.
- k. *Calibrations*: Calibration tests for all metering equipment, including mixing systems, delivery systems, alignment systems, mixing tool rotational and vertical speed, injection pressure, rotation penetration/extraction rates, etc. that are applicable to the mixing method being used on the project.
- l. *Surcharges/Berms*: Details of any surcharges/berms being constructed as indicated in the plans or required to obtain DSM column performance in accordance with plans and specifications. Provide a description of materials used (soil type, Atterberg limits, moisture content, etc.), location, and removal schedule (if required). Surcharges that are required to obtain DSM column performance and are not shown in the plans shall be constructed after being approved by the Engineer and at no additional cost to the Department.
- m. *Runoff and Spoil Containment (Wet Mixing Method Only)*: Details of all run-off and spoil containment structures will be required when DSM columns are constructed using the wet mixing method (DSM-SCC). These structures will be used to prevent the migration of either cement grout or soil-cement return spoils, disturbed in-situ soils, or other soil material beyond the immediate limits of the soil-cement mixing operation. Also provide description of processes and procedures to be used to collect and retain the soil-cement return and other spoil materials in such manner to allow the spoils to solidify for the necessary time to become a hardened material resembling a hard, dry cohesive material. The resulting hardened spoils shall be disposed of off-site, at no additional cost to the Department.
- n. *Daily Production Control Report and Installation Log*: Provide a sample report and installation log in paper and electronic format that will be used to record the construction of all production DSM columns for the required mixing method. The Daily Production Control Report/Log shall contain at least the following information:
 - 1) Project Name
 - 2) DSM column number and reference drawing number
 - 3) Date
 - 4) Name of DSM Superintendent and equipment operator
 - 5) Start/Finish time of DSM column installation
 - 6) Machine/Rig Number
 - 7) Type of mixing tool and indicate if single or multiple columns formed per stroke

EXHIBIT 5 – SPECIAL PROVISIONS AND CONTRACT REQUIREMENTS

- 8) DSM column(s) diameter/size
- 9) DSM column(s) total length (include top and bottom elevations)
- 10) DSM column center-to-center spacing from adjacent DSM column
- 11) Verticality of mixing tool in two orthogonal planes for each DSM column
- 12) Binder mix design designation used
- 13) A description of obstructions, interruptions, DSM column construction out of tolerance or other difficulties encountered during installation of DSM column and how they were resolved
- 14) *Material Certifications*: Supplier's certifications of binder materials quality and other additives, if used

Wet Mixing Method (DSM-SCC) reports shall include the following:

- 1) Final current draw for the drilling equipment at the bottom 2 feet of penetration or final hydraulic pressure, if hydraulic motors are used to turn the mixing tools
- 2) Grout injection pressure and volume
- 3) Estimate of spoil volume
- 4) Target and actual cement factors and grout specific gravity measurements per DSM-SCC column
- 5) Date, time, plan location, and elevation and other details of all soil-cement wet grab samples and any other samples taken during work shift
- 6) The following information shall be logged using automated computer technology for each DSM-SCC installed at intervals no greater than 4 feet and presented in table and graphical forms:
 - a) Elevation in feet
 - b) Mixing tool rotation penetration and withdrawal speed in revolutions per minute vs. depth in feet
 - c) Mixing tool rotation penetration and withdrawal rates in feet per minute vs. depth in feet
 - d) Mixing tool withdrawal rate in mm/revolution vs. depth in feet
 - e) Grout injection rate in gallons per minute vs. depth in feet
 - f) Average quantity of grout injected in gallons per foot injected per vertical foot of DSM-SCC vs. depth in feet

Dry Mixing Method (DSM-LCC) reports shall include the following:

- 1) Installation air pressure at tip and top of the lime-cement column
- 2) Target and actual binder dosage mixed per DSM-LCC column
- 3) The following information shall be logged using automated computer technology for each DSM-LCC installed at intervals no greater than 4 feet and presented in table and graphical forms:
 - a) Elevation in feet
 - b) Mixing tool rotation penetration and withdrawal speed in revolutions per minute vs. depth in feet
 - c) Mixing tool rotation penetration and withdrawal rates in feet per minute vs. depth in feet
 - d) Mixing tool withdrawal rate in mm/revolution vs. depth in feet
 - e) Quantity of binder reagent (i.e. quick lime, cement, and admixtures) injected in kg/ft
 - f) Average binder reagent injected in kg per foot injected per vertical foot of DSM-LCC vs. depth in feet.

2. Shop Plan/Working Drawing:

The Shop Plan/Working Drawing shall contain the location and extent of all production DSM columns that will be constructed as indicated in the plans. Indicate DSM column spacing and overlap dimensions, including overall dimensions of ground improvement area. Provide the production DSM column numbering system/identification for each location where DSM

columns will be constructed. Provide the sequence of DSM column construction that will be used to minimize the effects of ground movements on adjacent existing structures (i.e. MSE walls). The Shop Plan/Working Drawing shall be prepared, signed, and sealed by a professional engineer licensed in the State of South Carolina.

D. PRE-PRODUCTION FIELD AND LABORATORY TESTING

A pre-production field and laboratory testing program will be required to develop the proposed DSM wet or dry binder mix design prior to the construction of the test section(s). The field testing program consists of conducting a geotechnical subsurface investigation in accordance with subsection D.1 of this special provision. Soil samples obtained from the geotechnical subsurface investigation shall be used to develop and conduct the pre-production laboratory testing. The pre-production laboratory testing will be required to establish a “base line” of the degree of ground improvement that is possible under optimal construction circumstances for various DSM binder mixes for each distinct soil type that will be encountered during the conduct of the DSM ground improvement. It is recognized that the pre-production laboratory testing will be used as a general indicator of ground improvement that may be obtained in-situ because of substantial differences inherent between laboratory and in-situ mixing conditions. The Contractor shall take appropriate account of these differences, based on published documents and the Contractor’s experience, to develop a DSM binder mix design that can be used for constructing the test section(s) based on the results of the pre-production laboratory testing. A pre-production laboratory testing program shall be required for each test section. A DSM binder mix design shall be developed for each major soil type encountered throughout the depth of ground improvement. As a minimum, two binder mix designs for two types of soil shall be required per test section. The minimum pre-production laboratory testing requirements for wet and dry mixing methods are provided in subsections D.2 and D.3 of this special provision, respectively.

The Contractor shall submit the geotechnical subsurface investigation plan of the proposed field sampling and laboratory testing to the Engineer for review and approval a minimum of 14 calendar days prior to commencing the geotechnical subsurface investigation. The Contractor shall submit the results of the geotechnical subsurface investigation and the pre-production laboratory testing plan to the Engineer for review and approval a minimum of 14 calendar days prior to commencing the pre-production laboratory testing. The results of the pre-production field and laboratory testing along with the proposed DSM binder mix designs shall be included in the DSM Installation Plan submittal in accordance with section C.

1. Geotechnical Subsurface Investigation:

In-situ soils used for the pre-production laboratory testing shall be obtained from additional subsurface investigation conducted at or near the location of the approved test section(s) locations. The Contractor shall retain the services of a geotechnical consultant to drill several 3-inch continuously sampled soil borings to obtain sufficient material to perform the pre-production laboratory testing. The sampling shall be performed in such a manner that provides continuous, representative samples of the soil column. This can be effectively accomplished via Geo-probe sampling techniques, undisturbed sampling in fine-grained soils, split-spoon sampling, or any other sampling technique proposed by the Contractor and approved by the Engineer.

Contractor shall check for utility conflicts at boring locations with appropriate utility agencies, survey boring locations and survey locations tied to the project baseline alignment. The borings shall extend from the ground surface to the bottom elevation of the DSM columns shown in the plans to establish general soil and groundwater conditions in the vicinity of the work prior to construction of the test section(s). The geotechnical investigation shall be done in conformance with the latest version of the SCDOT Geotechnical Design Manual (GDM). SCDOT practices including but not limited to boring logs and laboratory data reporting shall be used. The geotechnical consultant shall classify and record soil types within 7 days of obtaining the samples in the field. The Geotechnical consultant shall perform laboratory testing on representative samples of the entire soil profile that will be subject to ground improvement. As a minimum, test six representative samples of cohesive soils taken from

different locations and four representative samples of cohesionless soils taken from different locations. The laboratory testing, as a minimum, will consist of the following:

- a. Cohesive and organic soils (i.e. peat) will be subject to laboratory tests that include, but not be limited to, moisture content, Atterberg limits, organic content, and unconfined compression tests.
- b. Cohesionless soils will be subject to laboratory tests that include, but not be limited to, grain size analysis, fraction passing #200 sieve, Atterberg Limits, and moisture content.

All soil samples to be used for the pre-production laboratory testing shall be stored in a manner that prevents any loss of moisture and in accordance with ASTM. Do not allow field samples of the clay to lose moisture between the time of removal from ground and pre-production laboratory mixing/testing.

2. **Pre-Production Laboratory Testing.**

Pre-Production laboratory testing will require the development of a DSM binder mix testing program for each type of soil where ground improvement will be performed to demonstrate that the required 28-day compressive strength indicated in the plans will be achieved. The soils obtained from the geotechnical subsurface investigation performed (Subsection D.1) will be used to perform the laboratory testing. All soil and mixed samples shall be kept out of sunlight at 70 degrees F and under fully humid conditions throughout storage and curing that prevents loss of sample moisture via evaporation.

DSM constructed using the wet mixing method (DSM-SCC) will require that the testing laboratory prepare the soil, mix the binder reagent (i.e. cement, etc.) and water to make grout, and then mix grout and soil together. The specimens shall be mixed using a minimum of four different DSM binder mixes to provide insight into the relationship of cement factor and grout water/cement ratio on the 28-day compressive strength of the soil-binder specimens. Binder materials and individual proportions of cement or admixtures (if used) used shall be documented for each specimen. The procedures outlined by Filz and Stewart (2005) may be used to provide guidance in developing a laboratory testing program.

DSM constructed using the dry mixing method (DSM-LCC) will require that the testing laboratory prepare the soil, binder reagent, and then mix the soil (at the same in-situ moisture) and binder reagent together. The specimens shall be mixed using a minimum of four different DSM binder mixes to provide insight into the relationship of binder proportions on the 28-day compressive strength of the soil-binder specimens. Binder materials and individual proportions of lime, cement, and admixtures (if used) used shall be documented for each specimen. The procedures outlined by Jacobson et.al (2003, 2005) may be used to provide guidance in developing a laboratory testing program.

All test specimens shall be prepared using the lab mixing energy level similar to energy levels used by the Contractor's field equipment. Test specimen cylinders shall be prepared according to procedures submitted to the Department and approved. Strength test three cylinders of soil-binder mixture at 3, 7, 14, 28, and 56 days following mixing. Strength testing shall be performed in accordance with subsection H.4.

E. DELIVERY, STORAGE, AND HANDLING OF MATERIALS

1. DSM Wet Mixing Method (DSM-SCC):

Portland cement shall be measured, handled, transported, and stored in bulk in accordance with the manufacturer's recommendations. Portland cement packaged in cloth or paper bags shall be sealed with plastic or rubber vapor barriers. The Portland cement shall be stored to prevent damage by moisture. Materials that become caked due to moisture absorption shall not be used. Bags of cement shall be stacked no more than ten bags high to avoid

compaction. Cement containing lumps or foreign matter of a nature that may be deleterious to the grout mixing or delivery or injection operations shall not be used.

2. DSM Dry Mixing Method (DSM-LCC):

The quicklime and cement shall be stored in closed pressure tanks suitable to be used as pressure vessels, for all pressures required, including those used to load and unload the materials. Delivery trucks shall be loaded at the manufacturer's plant unless approval is given for an intermediate storage facility. Each truck shall have a certified record of the weight of each load of material. The material shall be transported to the project site and blown into the on-site storage tanks using a pneumatic system. The air evacuated from the storage tanks during the loading process shall be filtered before being discharged to the atmosphere. A sealed refilling machine shall be used to transport material from the storage tanks to the DSM column mixing machine. This machine shall be refilled using a pneumatic system and an air filter, as specified above.

F. INSTALLATION EQUIPMENT

The DSM column construction equipment and support equipment shall be equipped with mixing tools that are capable of thoroughly blending the in situ soils and binder material into a homogeneous column of soil-binder to the depths and size required in the plans. The equipment shall be capable of advancing through previously installed and cured DSM columns as necessary for installing overlapping and end junction DSM columns. The DSM columns shall be constructed using computerized self-contained construction equipment.

1. DSM- SCC Construction Equipment:

The DSM-SCC construction equipment shall meet the following requirements:

- a. DSM-SCC shall be constructed using real-time computerized self-contained DSM-SCC construction equipment capable of monitoring, controlling, and recording installation data. The DSM-SCC construction equipment shall be equipped with electronic sensors, built into the soil mixing equipment, to perform the following:
 - 1) Determine vertical alignment of the leads in two directions: fore-aft and left-right. The verticality shall be measured using instrumentation that is capable of measure deviations from verticality to an equivalent of 1-inch in 100-feet.
 - 2) Monitor cement and water proportioning, grout mixing, and water-cement ratios.
 - 3) Monitor the mixing tool depth and penetration/withdrawal speed, and mixing tool rotation speed.
 - 4) Monitor mixing tool withdrawal speed, and mixing tool rotation speed.
 - 5) Monitor injection quantities and pressure with flow meter and other measuring equipment having precision accuracy not less than 99.5 percent.
 - 6) All output from the sensors shall be routed to a console that is visible to the operator and the Engineer during penetration and withdrawal.
 - 7) The sensors shall be calibrated at the beginning of the project and calibration data provided to the Engineer. The calibration shall be repeated at intervals not to exceed one month.
 - 8) All of these monitored functions shall be fully adjustable during operation of the equipment.
- b. The DSM-SCC construction equipment power source for driving the mixing tool shall be sufficient to maintain the required revolutions per minute (RPM) or injection pressure and penetration rate from a stopped position at the maximum depth required as determined from the test section(s) for group and/or block DSM column spacing. The Contractor shall also consider the wide range of expected subsurface conditions, indicated by the available geotechnical information.
- c. The DSM-SCC construction equipment shall utilize sufficient mixing and injecting equipment to adequately produce a homogeneous distribution of cement grout throughout the mixed in-situ soils that meet the acceptable criteria. The mixing tools shall

EXHIBIT 5 – SPECIAL PROVISIONS AND CONTRACT REQUIREMENTS

uniformly inject cement grout through hollow stem or other piping at locations that distribute the grout across the full diameter of the mixing tools and such that the full auger/mixing paddle assembly passes through the column of soil after the grout is introduced, on both the insertion and withdrawal strokes. Grout shall only be injected in direction within the diameter of the augers or mixing paddles. If grout injection jets are used, they shall not spray beyond the auger diameter.

- d. Continuous auger flights longer than 3 feet or with more than one full, uninterrupted revolution of auger are not allowed as part of the mixing tools. Auger flights and mixing paddles on a shaft shall all reach to the full column diameter, and shall have discontinuous lengths and be so oriented as to thoroughly break up the in-situ soils, and disperse and blend soils with injected cement grout to form a homogeneous soil-cement mixture.
- e. The auger mixing equipment shall form the required diameter and size of the DSM-SCC as submitted by the Contractor's approved submittals.
- f. Injection volume estimates shall be only made by precision inline flow meters. Counting or measuring grout pump strokes shall not be acceptable. Injection quantities must be measured in real time by direct measurements of volume and/or mass for each DSM column having injection capabilities, with flow meters and other measuring equipment having precision accuracy not less than 99.5%. Gages and flow meters and other measuring equipment shall be calibrated and certified as precise and accurate before the start of the equipment's work on the project, and then again every 4 months.
- g. The DSM-SCC construction equipment shall be adequately marked to allow the Engineer to confirm the penetration depth to within 6 inches during construction.
- h. The cement grout batching plant shall include all storage silos and sheds, pumps, scales, mixers, valves, gauges, and regulating devices required to continuously measure and mix cement grout in real time. Grout shall be mixed in a mixing plant, using a batch process, which combines dry materials and water in predetermined proportions. The plant mixer shall consist of grout mixer, grout agitator, grout pump, automatic batching scales, and a computer control unit. The mixing plant shall meet the following requirements:
 - 1) To accurately control grout mix proportions, the addition of water and cement shall be determined by weight using automatic batch scales in the mixing plant.
 - 2) Admixtures, if used, may be delivered to the mixing plant by calibrated auger provided the Contractor can demonstrate that the auger can deliver the material at the same accuracy as by weight.
 - 3) The mixing components shall be calibrated prior to beginning the work and monthly thereafter. The calibration data shall be provided to the Engineer.
 - 4) The mixing plant shall have tanks or silos with adequate storage for continuous production. The tanks shall be equipped with air filters.
- i. Positive displacement pumps shall be used to transfer the grout from the mixing plant to the mixing tool. If the DSM-SCC construction equipment has multiple shafts, and multiple mixing tools, the grout shall be delivered to each shaft by an individual positive displacement pump.
- j. All gauges, flow meters, metering equipment, and other measuring equipment shall be calibrated and certified as precise and accurate before starting DSM column construction (i.e. test section(s) or production DSM columns), and then again every 4 months or at least every 325,000 feet of DSM column installed, whichever is sooner. The calibrations and certifications shall be supplied to the Engineer.

2. DSM- LCC Construction Equipment:

The DSM-LCC construction equipment shall meet the following requirements:

- a. DSM-LCC shall be constructed using real-time computerized self-contained DSM-LCC construction equipment capable of monitoring, controlling, and recording installation data.

EXHIBIT 5 – SPECIAL PROVISIONS AND CONTRACT REQUIREMENTS

The DSM-LCC construction equipment shall be equipped with electronic sensors, built into the soil mixing equipment, to perform the following:

- 1) Determine vertical alignment of the leads in two directions: fore-aft and left-right. The verticality to an equivalent of 1-inch in 100-feet
 - 2) Monitor the mixing tool depth, penetration/withdrawal speed, mixing tool rotation speed, and injection pressure
 - 3) All output from the sensors shall be routed to a console that is visible to the operator and the Engineer during penetration and withdrawal
 - 4) The sensors shall be calibrated at the beginning of the project and calibration data provided to the Engineer. The calibration shall be repeated at intervals not to exceed one month
 - 5) An alternative display/monitoring system may be used subject to review and approval by the Engineer prior to use
 - 6) All of these monitored functions shall be fully adjustable during operation of the equipment
- b. The DSM-LCC construction equipment power source for driving the mixing tool shall be sufficient to maintain the required revolutions per minute (RPM) or injection pressure and penetration rate from a stopped position at the maximum depth required as determined from the test section. The Contractor shall also consider the wide range of expected subsurface conditions, indicated by the available geotechnical information.
- c. The DSM-LCC construction equipment shall be adequately marked to allow the Engineer to confirm the penetration depth to within 6 inches during construction.
- d. All gauges, flow meters, metering equipment, and other measuring equipment shall be calibrated and certified as precise and accurate before the starting DSM column construction (i.e. test section(s) or production DSM columns), and then again every 4 months or at least every 325,000 feet of DSM column installed, whichever is sooner. The calibrations and certifications shall be supplied to the Engineer.

G. CONSTRUCTION REQUIREMENTS

The Contractor shall furnish all materials, labor and equipment necessary to construct the DSM columns in accordance with the plans and specification. The DSM columns shall be constructed to the lines, grades, and cross sections indicated in the Plans. The completed DSM improved zone shall be a homogeneous mixture of binder material constructed in accordance with the method of mixing and column spacing indicated in the plans.

Production DSM shall be constructed using the same equipment and construction criteria (i.e. mix design, mixing parameters, etc.) established in the accepted test section construction (subsection I). DSM construction that is out of tolerance (subsection G.4) or is subject to unforeseen conditions (subsection G.5) shall be evaluated and corrected as approved by the Engineer with no additional cost or schedule impact to the Department.

1. Site Preparation:

The presence and location of buried pipes, sewers, and other utilities shall be identified and precautions taken to protect the utilities from damage during the construction of the DSM columns. The Contractor shall be responsible for any damage resulting from the construction of the DSM columns. The site shall be cleared and grubbed in accordance with the Contract documents. Limit grubbing to that needed to remove previous construction materials, trees, stumps, and large roots. Fill in holes left by construction materials, stumps and root extraction and grade to provide level working surface. Place bridge lift materials as required in the plans and contract documents.

Establish DSM column limits and locations by a licensed surveyor. Individual column locations shall be marked. Sufficient horizontal and vertical control shall be provided to establish that DSM columns are located accurately and reach the required plan depths.

2. DSM-SCC Soil-Grout Mixing:

Soil shall be broken up and blended with grout in place by the pugmill type action of the soil mixing equipment. The completed DSM-SCC shall be a uniform mixture of cement and the in situ soils. The soil-grout mixture shall achieve an average unconfined compressive strength in 28 days as indicated in the plans. Soil mixing shall be performed with the following minimum requirements:

- a. *Grout Preparation:* The dry materials shall be fed to the mixers for agitation and shearing. The mixing ratio of the grout shall be controlled by measuring the weight of grout components using automatic batch scales in the mixing plant. Grout mixture shall be mixed for a minimum of three minutes, with a maximum holding time of two hours, calculated from the beginning of initial mixing. The specific gravity of the grout (determined in the test section) shall be tested at least once per shift per rig, using the methods outlined in ASTM D 4380, and shall not deviate more than three percent from the calculated specific gravity for the design cement ratio. Additional tests may be required by the Engineer. If the specific gravity or density is lower than the design mix, the Contractor shall add additional cement, remix, and/or recalibrate batch scales and retest the grout until the design density is achieved, at no additional cost to the Department.
- b. *Grout Injection:* The grout shall be pumped through and injected from the mixing tool. The grout injection rate per vertical foot of DSM-SCC shall be in accordance with the requirements of the design mix established during the test section. Injection rates falling below this requirement, shall require the DSM-SCC to be remixed and additional grout injected (at the design grout-soil ratio) to a depth at least three feet below the deficient zone, at no additional cost to the Department. The Contractor may sample using wet grab methods for his own purposes. The Department will not accept results from wet sampling for quality control purposes.
- c. *Rotation Speeds:* The mixing tool rotational speeds (measured in RPM) and penetration/withdrawal rates shall be in accordance with the parameters established during the test section(s). If these parameters are varied more than 15 percent from those determined during the test section(s), the DSM-SCC section shall be remixed while injecting grout at the design grout ratio to a depth at least three feet below the deficient zone, at no additional cost to the Department.
- d. *On-Board Computer:* The preset data in the on-board computer shall be verified for each column as correct and adjusted if necessary. The operator shall monitor and adjust as necessary during column installation the feeding of material, the grout injection rate, the mixing tool rates of rotation, and penetration/withdrawal rates of the mixing tool.
- e. *Changes in Grout Mix Design:* The Contractor may request that the established grout mix be modified during the production DSM-SCC installation. To verify acceptable results for the modified mix design, the Engineer may require additional testing or a new test section, at no additional cost to the Department.
- f. *Spoils:* During the course of soil-cement stabilization, return/spoil material shall not be dumped into or otherwise be allowed to enter the soil-cement column. The Contractor shall develop a spoil containment system that allows the channeling of the spoils to the temporary holding pit in such a direction and manner as to keep the spoils away from the site perimeter, and out of the traveled paths. Soil-cement return and spoil material shall be piped or channeled to holding ponds or other retention structures within the work area. The Contractor shall remove all excess grout and grout mixed soil generated from ground improvement activities from the construction site in accordance with the approved DSM Installation Plan.

The Contractor shall take all necessary precautions and implement measures to prevent any soil-cement return, other spoil material or stockpiled materials from entering storm drain structures, drainage courses, other utility lines, or from leaving the site via surface runoff. The Contractor shall prevent soil-cement return, fluid, ponded spoil material, or

stockpiled solidified materials from migrating into any water body. In the event soil-cement return, spoil material or stockpiled materials enter storm drain structures, drainage courses, or other utilities, including, but not limited to, surface water bodies beyond site limits of soil-cement mixing operations, the Contractor shall collect and remove all of these materials, and perform all other required/necessary remediation that may be directed by the Engineer or responsible environmental agency, at no additional cost or schedule impact to the Department. The Contractor shall conduct all soil-cement operations to conform to sedimentation and turbidity control requirements of federal, state, and local agencies having jurisdiction over the work.

- g. *Delays:* The installation of each DSM-SCC column shall be continuous without interruption. If an interruption of more than two hour occurs, the DSM-SCC shall be remixed for the entire column height using fresh cement grout as though there had not been any cement grout installed, or the column may be abandoned, at no cost or schedule impact to the Department. The Contractor shall install additional columns if the interrupted columns cannot be acceptably remixed.
- h. *Instability:* Soil-cement column which exhibits partial or total instability at any time, or collapses as a result of mechanical failure of any equipment; inadequacy of cement, water supplies, cement grout; improper drilling, injection or mixing procedures; or other cause, the Contractor shall halt DSM-SCC construction and backfill to ground surface with cement grout. After the backfill has attained sufficient strength to stabilize the ground, complete the required installation by re-drilling from ground surface, at no additional expense to the Department. The Engineer will evaluate the potential impacts of the instability and may require one or more additional re-drilled columns at overlapping or adjacent locations as determined by the Engineer, and at no additional expense to the Department.
- i. *Daily Quality Control Report:* The Contractor shall submit a Daily Quality Control Report for each day that DSM-SCC work is performed. The log shall contain as a minimum the information listed in Section C. The report shall be delivered to the Engineer by the end of the next working day following the report date.
- j. *Protective Covers:* Immediately after completing a soil-cement column, the Contractor shall install protective covers to prevent persons from falling or stepping into the unhardened soil-cement column.

3. **DSM-LCC Soil-Binder Mixing:**

Soil shall be broken up with the mixing tool. As the mixing tool is raised the binder material (i.e. lime-cement or cement) is injected using air pressure. The binder-soil mixture shall achieve an average unconfined compressive strength in 28 days as indicated in the plans. Soil mixing shall be performed with the following minimum requirements:

- a. *Binder Injection:* The binder (i.e. lime-cement or cement) volume flow rate per vertical foot of DSM-LCC shall be in accordance with the requirements of the design mix established during the test section. Injection rates falling 10 percent below this requirement, shall require the DSM-LCC to be remixed and additional binder injected (at the design rate) to a depth at least three feet below the deficient zone, at no additional cost to the Department.
- b. *Rotation Speeds:* The mixing tool rotational speeds (RPM) and the penetration/withdrawal rates shall be in accordance with the parameters established during the test section(s). If these parameters are varied by more than 15 percent from those determined during the test section(s), the DSM-LCC section shall be remixed using the design binder volume flow rate to a depth of at least three feet below the deficient zone, at no additional cost to the Department.
- c. *On-Board Computer:* The preset data in the on-board computer shall be verified for each column as correct and adjusted if necessary. The operator shall monitor and adjust as

necessary during DSM column installation the feeding of material, the injection air pressure, and the rates of rotation and rise.

- d. *Changes in Binder Mix Design:* The Contractor may request that the established mixing parameters be modified during the production DSM-LCC installation. To verify acceptable results for the modified parameters, the Engineer may require additional testing or a new test section, at no additional cost to the Department.
- e. *Delays:* The installation of each DSM-LCC column shall be continuous without interruption. If an interruption of more than two hours occurs, the DSM-LCC shall be remixed for the entire column height using design binder rates as though there had not been any binder installed, or the column may be abandoned, at no cost or schedule impact to the Department. The Contractor shall install additional columns if the interrupted columns cannot be acceptably remixed.
- f. *Daily Quality Control Report:* The Contractor shall submit a Daily Quality Control Report for each day that DSM-LCC work is performed. The log shall contain as a minimum the information listed in Section C. The report shall be delivered to the Engineer by the end of the next working day following the report date.

4. DSM Column Construction Tolerances:

- a. *Horizontal Alignment:* The location of the DSM column shown in the Plans shall be accurately staked by a licensed surveyor before beginning installation. The horizontal alignment of DSM columns with group column spacing (GCS) shall be within 4 inches of the planned DSM top location. The horizontal alignment of DSM columns with block column spacing (BCS) shall be within 20 percent of the DSM column diameter, not to less than four inches, of the planned DSM top location in order to obtain sufficient DSM column overlap.
- b. *Vertical Alignment:* The equipment operator shall control vertical alignment of the equipment and constructed DSM column. Two measures of verticality shall be monitored, longitudinal and transverse to the DSM column alignment. The DSM column shall be installed at an inclination that deviates no more than 1:100 (horizontal to vertical).
- c. *DSM Column Lengths:* The tops of the DSM columns shall begin at the ground surface. The top of DSM column elevations shown in the plans are approximate. Natural soils above the water table, at the completion of DSM installation, shall have been treated to produce the full column design strengths up to within 3 feet of the ground surface. If the top of the DSM columns is being constructed within a surcharge or berm, the top of DSM column elevations shown in the plans shall be used.

The bottom of DSM columns shall extend to the line and grades shown in the plans. The DSM column bottom elevations indicated in the Plans provide the minimum required penetration of the DSM columns. The Engineer may require the Contractor to shorten or deepen the bottom of DSM columns indicated in the plans.

- d. *DSM-LCC Width:* When DSM columns are constructed using group column spacing (GCS) the DSM column diameter shown in the plans shall be the minimum required diameter. The diameter of DSM columns constructed using block column spacing (BCS) may vary to accommodate variations in the Contractor's equipment dimensions, provided that the plan area of ground improvement does not exceed the dimensions shown in the Plans more than six inches and is approved by the Engineer.

5. Unforeseen Conditions and Corrective Remediation:

Unforeseen conditions that result in deficient DSM column construction shall be remediated by the DSM Contractor at no additional cost to the Department. DSM column construction deficiencies and how they were addressed shall be noted in the DSM Daily Production Control Report and Installation Log. DSM column deficiencies that result from changes in rotation speeds of mixing tools, rate of penetration/withdrawal of mixing tools, changes in the rate of grout/binder injection, delays, or changes in binder mix shall be corrected as

indicated in subsections G.2 and G.3 for DSM-SCC mixing and DSM-LCC mixing, respectively.

If unforeseen conditions result in DSM column interruptions that do not meet the DSM construction requirements (subsections G.2 or G.3), the DSM column installation shall be re-drilled a minimum of 1 foot below the elevation of the interruption and the DSM column construction restarted.

When interruption of the installation process occurs because of unknown obstructions or a very dense layer above the planned tip elevation, the Contractor shall document the interruption on the DSM Daily Production Control Report and Installation Log and notify the Engineer in writing by the end of that day of such encounter and shall provide all pertinent information relating to DSM column identification, plan location coordinates, depth, and expected extent of the obstruction. The Contractor shall be prepared to penetrate very dense layers by first removing mixing tools from the excavation and then using auger drilling equipment or other approved methods to allow the installation of the DSM column. When unknown obstructions are encountered, the Contractor shall submit a proposal to the Engineer for review that delineates the Contractor's proposed means and methods to overcome the unknown obstruction, including equipment and labor time estimated for this operation. Such construction to remove an unanticipated obstruction shall only be performed with the written authorization of the Engineer. When the obstruction cannot be penetrated or removed, the DSM column shall be completed to the maximum depth penetrated. The need for an alternate design or remedial construction shall then be determined by the Engineer.

Deficient DSM columns due to out of tolerances (subsection G.4) or not in compliance with DSM construction acceptance (subsection G.6) will require that the DSM Contractor to submit proposed remedial measures to the Engineer for review and approval. Remedial plans shall show the location, depth, construction exceptions requested, and proposed method of remediating the deficient DSM ground improved areas. Remedial plans, if accepted, shall be at no cost or schedule impact to the Department.

6. DSM Construction Acceptance:

The QC reporting (logs), testing, and acceptance procedures for the DSM test section(s) and production DSM columns shall be the same. QC testing methods are described in Section H and Acceptance Criteria are provided in Section K.

H. DSM TESTING METHODS

QC testing of DSM columns consists of using field and laboratory testing techniques to evaluate the integrity, consistency, and strength of the DSM column for the entire full depth of soil improvement. QC testing methods that will be used include probe testing (subsection H.1), soil borings and undisturbed sampling with Shelby tubes (subsection H.2), and coring and sampling (subsection H.3). Samples obtained by undisturbed sampling with Shelby Tubes or coring shall have samples tested for compressive strength testing (subsection H.4). DSM testing shall be conducted in accordance with the SCDOT Geotechnical Design Manual, version 1.1 (2010), or later.

The results of the compressive testing shall be used to develop correlations for use with probe testing and therefore improve the reliability of the probe testing results. This will be accomplished by performing continuous undisturbed Shelby tube sampling and/or coring in one quadrant of the DSM column and probe testing in another quadrant of the same DSM column.

Any of the DSM testing methods presented may be used on production DSM columns to evaluate deficiencies based on construction records or field observations.

1. Probe testing:

EXHIBIT 5 – SPECIAL PROVISIONS AND CONTRACT REQUIREMENTS

- a. Probe testing shall be conducted using the seismic cone penetrometer test with pore pressure measurements (SCPTu). The SCPTu testing results (i.e. tip resistance, friction sleeve resistance, pore pressure, and shear wave velocity vs. depth of penetration) shall be provided graphically and in electronic file format to the Engineer.
 - b. Probe testing shall be performed in the presence of the Engineer, unless otherwise directed. The Contractor shall notify the Engineer at least seven calendar days in advance and confirmed 2-days (48 hours) prior to beginning SCPTu operations.
 - c. The SCPTu testing shall be conducted in accordance with the SCDOT Geotechnical Design Manual.
 - d. Probe testing shall be performed after the soil-binder mixture has hardened sufficiently, but before it has cured to the extent to cause refusal to the SCPTu equipment.
 - e. Unless directed otherwise by the Engineer, probe tests shall be performed along an essentially vertical alignment located within one of the quadrants of the DSM column and shall include inclinometer measurements that confirm the verticality of the SCPTu test data such that the entire probe test is determined to have been advanced within the DSM column. The SCPTu shall be taken at a distance of $2/5$ the DSM column radius from the center of the DSM column.
 - f. If seismic cone shear wave testing results are inconclusive, the SCPTu may be discontinued and cone penetrometer test with pore pressure measurements (CPTu) may be used with written approval from the Engineer.
 - g. The CPT testing equipment shall be sized to allow full penetration and testing to the depth of the planned test DSM column plus 10 feet.
 - h. If standard full-size CPT truck equipment (i.e. 20-30 ton reaction truck) is not capable of testing to the desired depths, the Contractor shall conduct SPT testing in accordance with the SCDOT Geotechnical Design Manual, at no additional cost to the Department. SPT shall be conducted on a maximum five foot center interval to the depth of the planned test DSM column plus 10 feet.
 - i. All probe test holes shall be filled with cement grout that will obtain 28-day strength equal to or greater than the DSM column compressive design strength required in the plans.
- 2. Soil Borings and Undisturbed Sampling:**
- a. Soil borings and undisturbed Shelby tube sampling shall be performed in the presence of the Engineer, unless otherwise directed. The Contractor shall notify the Engineer at least seven calendar days in advance and confirmed 2-days (48 hours) prior to beginning soil boring operations.
 - b. Soil borings and sampling shall be conducted in accordance with the SCDOT Geotechnical Design Manual.
 - c. High quality undisturbed sampling shall be obtained after the soil-binder mixture has hardened sufficiently to a minimum compressive strength of 3 psi (430 psf) but not greater than 55 psi (7,900 psf).
 - d. Unless directed otherwise by the Engineer, soil borings shall be obtained along an essentially vertical alignment located within one of the quadrants of the DSM column. The soil boring shall be taken at a distance of $2/5$ the DSM column radius from the center of the DSM column.
 - e. Sampling shall be conducted using a thin wall Shelby tube sampler and/or pitcher barrel sampler in accordance with the SCDOT Geotechnical Design Manual.
 - f. Upon Shelby tube retrieval, the samples shall be logged visually without extraction of the samples from the Shelby tube and sealed to prevent loss of moisture during transport.

- g. Undisturbed samples shall be transported by the Contractor to the independent AASHTO certified materials testing laboratory where the samples will be extracted, stored, and tested.
- h. Upon extraction of the samples at the independent materials testing laboratory, the samples shall be logged and documented by taking pictures. The percent recovery per Shelby tube sampler based on the sampler penetration shall be documented. Samples shall be selected for testing and submitted to the Engineer for approval. Samples shall be stored and cured in accordance with ASTM D 1632 until the test date.
- i. All soil boring holes shall be filled with cement grout that will obtain 28-day strength equal to or greater than the DSM column compressive design strength required in the plans.

3. Coring and Sampling:

- a. Coring/sampling shall be performed in the presence of the Engineer, unless otherwise directed. The Contractor shall notify the Engineer at least seven calendar days in advance and confirmed 2-days (48 hours) prior to beginning coring/sampling operations.
- b. High quality continuous core sampling shall be obtained after the soil-binder mixture has hardened sufficiently to approximately a compressive strength of 42 psi (6,050 psf).
- c. Unless directed otherwise by the Engineer, core runs shall be obtained along an essentially vertical alignment located within one of the quadrants of the DSM column. The core run shall be taken at a distance of 2/5 the DSM column radius from the center of the DSM column.
- d. Coring shall be conducted using double or triple tube samplers to obtain samples of 2.5 inches in diameter or greater. Triple tube core barrel may be required by the Engineer, at no additional cost to the Department, if the sample quality of the double tube core barrel is not providing high quality samples suitable for compression strength testing.
- e. Each core run shall be at least four feet in length and contain at least four acceptable test specimens. Three samples per core run are required to perform compressive strength testing with one reserve sample.
- f. A minimum core run recovery of 85 percent for each 4-foot-long core run shall be achieved. During coring, the elevation of the bottom of the holes shall be measured after each core run in order that the core recovery for each run can be calculated. The core recovery and RQD for every core run shall be reported in the logs. Additional cores may be required, at no additional cost to the Department, if core run recovery is less than 85 percent.
- g. Upon retrieval, the samples shall be field logged and documented by taking pictures. Samples shall be selected for testing and submitted to the Engineer for approval.
- h. Following logging and test specimen selection, the entire full-depth sample, including the designated test specimens, shall be immediately sealed in plastic wrap to prevent drying, placed in suitable core boxes, and transported to the materials testing laboratory by the Contractor within 24 hours.
- i. All core holes shall be filled with cement grout that will obtain 28-day strength equal to or greater than the DSM column compressive design strength required in the plans.
- j. Cores shall be transported by the Contractor to the independent AASHTO certified materials testing laboratory where the samples will be stored and tested. Samples shall be stored and cured in accordance with ASTM D 1632 until the test date.

4. Strength Testing of Samples:

- a. All samples shall be kept out of sunlight at 70 degrees F and under fully humid conditions throughout storage and curing that prevents loss of sample moisture via evaporation.
- b. Samples suitable for strength testing shall have a height to diameter ratio of 2.0.

- c. Strength testing shall be performed by unconfined compression testing method per AASHTO specification T-208-96, but with strain rate not faster than 0.5% per minute, but not slower than 0.25%/minute, and with test equipment set up to record in both tabular and graphical form the axial stress and strain constant increments of axial strain no larger than every 0.05% axial strain. The Contractor will be permitted to perform UU Triaxial Compressive Tests, with approval of the Engineer, in lieu of performing unconfined compressive strength test, at no additional cost to the Department.
- d. Compressive strength testing results shall be transmitted to the Engineer for review within 24 hours of the compression test completion. The remaining portions of the full-depth samples that are not tested shall be retained by the Contractor, until completion and acceptance of the work, for possible inspection and confirmation testing by the Engineer.

I. DSM TEST SECTION AND QC TESTING PROGRAM

The QC testing program for each test section will be submitted to the Engineer within 5 days after test section DSM column installation and shall be based on the results of DSM pre-production laboratory testing, early probe testing (3 and 5 days after column installation), and review of samples obtained for strength testing. The approved compressive strength testing program (i.e. Plan location, sample depth, and elapsed time after construction to perform compressive testing) shall then be submitted to the Contractor's independent AASHTO certified laboratory testing firm.

Unless otherwise directed by the Engineer, a minimum of four Plan locations shall have QC testing, per test section. QC testing at each Plan location shall consist of full-depth continuous soil borings or corings per subsections H.2 and H.3, respectively. Soil boring or coring sampling shall be performed in one DSM column quadrant, while probe testing, per subsection H.1, shall be performed in another DSM column quadrant. A minimum of six samples at each QC testing Plan location shall be selected by the Contractor and approved by the Engineer for compressive strength testing. Compressive strength testing of cores (subsection H.4) and probe testing (Section H.1) at QC testing Plan locations shall be conducted at 7, 14, 28, and 56 days after test DSM column installation. The results of the compressive testing shall be used to develop correlations for use with probe testing and therefore improve the reliability of the probe testing results. A test DSM column compressive strength testing report shall be compiled by the independent testing company and submitted to the Contractor and the Engineer. The compressive strength testing report shall document the soil boring/core sampling and compressive strength testing conducted on the cores.

In addition to probe testing conducted at QC testing Plan locations, full depth probe testing shall be conducted at two separate plan locations within the test section in separate DSM column quadrants at 3, 7, 14 and 28 days after test DSM column installation. A probe testing report shall be compiled of all testing results in accordance with Section G.2.

The Contractor shall use the results of the test sections to establish the DSM production construction criteria. The DSM production construction criteria shall be developed to produce DSM columns that meet the Acceptance Criteria in Section K. DSM production construction criteria for DSM columns shall include as a minimum, the following criteria.

DSM-SCC Production Construction Criteria:

1. Grout mix design including ratios of all materials mixed to form the grout
2. Grout specific gravity
3. Grout injection rates
4. Type of equipment
5. Mixing tool penetration and withdrawal rates

6. Mixing tool rotation speed
7. Construction procedures and techniques

DSM-LCC Production Criteria:

1. Binder mix design including ratios of all materials (i.e. lime-cement or cement) mixed to form the soil-binder material
2. Lime-cement injection rates
3. Type of equipment
4. Mixing tool penetration and withdrawal rates
5. Mixing tool rotation speed
6. Construction procedures and techniques

The Contractor shall use the results of the test sections to establish the Production Quality Control (QC) testing program per Section J.

Construction of production DSM columns may begin only after written acceptance by the Engineer of the “DSM Production Construction Criteria” and the “Production Quality Control (QC) Testing Program.” If construction criteria, construction procedures, equipment, new mobilizations, or changes in personnel are made, following acceptance of the test sections, the Department reserves the right to require the Contractor to construct a new test section at no additional cost to the Department.

J. PRODUCTION QC TESTING PROGRAM

The Production QC Testing program shall be developed by the Contractor and approved by the Engineer. The Production QC Testing program will be required to include probe testing per subsection H.1 and strength testing of samples per subsection H.4. The following minimum requirements shall be used to developing the Production QC Testing Program:

DSM QC Testing Program Minimum Requirements:

1. The Production QC Testing Program goal is to establish continuity/integrity of the columns and to obtain a measure of their strength. This is accomplished by using the QC Testing to evaluate if the DSM ground improvement is meeting the Acceptance Criteria in Section K.
2. Provided that acceptable correlations can be developed between probe testing and compression strength testing, QC probe testing per subsection H.1 shall be performed at a minimum frequency of 5 percent of production columns (1:20) but not less than 1 QC probe test for every 200 cubic yards of DSM stabilized volume.
3. One Soil boring/Coring full depth of DSM columns plus 10 feet with a minimum of one strength test per 5 feet of penetration of stabilized soil (Section H) shall be obtained adjacent to probe testing (adjacent DSM quadrant) at a minimum frequency of 0.5 percent of production columns (1:200) but not less than 1 QC probe test for every 2,000 cubic yards of DSM stabilized volume.
4. If acceptable correlations cannot be developed between probe testing and compression strength testing, one Soil boring/Coring full depth of DSM columns plus 10 feet with a minimum of one strength test per 5 feet of penetration of stabilized soil (Section H) shall be obtained adjacent to probe testing (adjacent DSM quadrant) at a minimum frequency of 1.0 percent of production columns (1:100) but not less than 1 QC probe test for every 1,000 cubic yards of DSM stabilized volume.
5. The QC Testing program shall define the limits of the production DSM testing based on the number of rigs operating, anticipated production schedule, and the minimum QC testing criteria defined above.

EXHIBIT 5 – SPECIAL PROVISIONS AND CONTRACT REQUIREMENTS

6. The QC Testing program shall include provisions for revising QC testing frequency as a result of failing DSM Acceptance Criteria, changes in construction criteria, construction procedures, equipment changes, new mobilizations, or changes in personnel that are made following acceptance of the test sections.
7. The Department reserves the right to require the Contractor to perform additional QC testing after review of the daily Quality Control Report/Log of the production DSM columns and/or review of QC Testing results. Although coring and conducting compressive strength testing of cores (Section G.1) is not intended to be a routine QC testing method, the Engineer reserves the right to use this QC testing method based on the results of the probe testing at any time.
8. The Contractor shall determine the time interval between DSM installation and QC testing. QC testing shall be performed on columns cured for a minimum of 3 days but no longer than 28 days, or as directed by the Engineer.
9. Only probe testing equipment and methods that have been calibrated during the test section shall be used for QC testing. If production DSM columns are being installed differently from the test section DSM column installation, a calibration of the probe testing with coring and compression testing shall be required unless approved otherwise by the Engineer.

K. ACCEPTANCE CRITERIA

Determination that the DSM columns meet the Acceptance Criteria (for DSM construction, DSM column continuity, and DSM compressive strength requirements) shall be evaluated solely by the Engineer based on a review of daily Quality Control Report/Log of the production DSM columns and QC testing results conducted by an independent testing company.

1. DSM Construction Acceptance Criteria:

DSM columns shall be considered acceptable when daily Quality Control Report/Log of the production DSM columns and any remediation reports indicate that the:

- a. Location of the top of the columns has been verified to be within design tolerances
- b. Penetration of the column has been verified as correct by the Engineer.
- c. Continuously recorded injection quantity of cement grout for DSM-SCC and binder (lime-cement or cement) for DSM-LCC columns has been verified to be within 10% of the design (preset) value established for the production DSM construction criteria based on the results of approved production DSM construction design criteria.

2. Evaluation of DSM Column Continuity:

Lumps of unimproved soils shall not amount to more than 15 percent of the total volume of any 4-foot section of continuous full-depth evaluation by either conducting continuous probe testing, soil borings, or coring. Any individual or aggregation of lumps of unimproved soil shall not be larger than 6 inches in greatest dimension. For evaluating the volume of unimproved lumps of soil, all of the unrecovered samples shall be assumed to be unimproved soil. In addition, within a sample, the sum length of unmixed or poorly mixed soil regions or lumps that extend entirely across or a portion thereof the diameter of the sample will be considered unimproved.

3. Design Compressive Strength Acceptance:

Unless directed otherwise by the Engineer, all DSM QC compressive strength test results shall indicate a minimum of 60 percent of the design compressive strength at 5 days or less. Failure to meet this criterion shall deem the DSM column to be in non-conformance of the DSM compressive strength acceptance criterion. The DSM column shall be retested (same DSM column, different quadrant) at 28 days where the average QC strength testing shall indicate 100 percent or more of the compressive design strength with no sample testing less than 85 percent of the compressive design strength. Failure to meet the 28 day QC strength testing criterion shall deem the DSM column to be in non-conformance of the DSM

compressive strength acceptance criteria. The Contractor may elect to conduct additional QC strength testing in excess of 28 days, with approval of the Engineer, at no additional cost to the Department. Unless otherwise determined by the Engineer, the extent of the non-conformance QC test area shall be considered to include all DSM constructed during all rig shifts that occurred after construction when passing tests were achieved. Non-conforming DSM QC test areas shall be remedied by the Contractor by conducting the following procedures.

The Contractor may conduct two or more additional QC probe tests (locations designated by the Contractor and approved by the Engineer) to better define the limits of the non-conformance and submit the results of those tests for review by the Engineer at no additional cost to the Department. If a minimum of 60 percent of the design strength has been achieved at 5 days or less, the Engineer shall evaluate the DSM construction documentation to determine which DSM columns are in conformance. If compressive strength criteria are achieved, with approval of the Engineer, all or a portion of the production DSM QC testing area may be approved provided that any deficient production DSM columns are remedied by one of the following two options. Failure to meet the required design strength of the additional DSM QC testing shall require that the DSM QC test area be remedied by one of the following options as approved by the Engineer.

- a. Provide 2 or more additional QC tests (locations designated by the Engineer) within the DSM QC test area which demonstrate that at 28 days, the average QC strength testing is 100 percent or more of the compressive design strength with no sample testing less than 85 percent of the compressive design strength.
- b. Re-drilling all or a portion of the nonconforming DSM QC test area and mixing additional cement grout for DSM-SCC columns or binder material (lime-cement or cement) for DSM-LCC, while raising the mixing tool. The Contractor shall submit a proposed plan for remixing or repair of failed sections for review and approval by the Engineer. Repair work of failed DSM columns shall be performed at no additional cost to the Department. Changing grout or binder quantities may require additional QC testing to calibrate QC probe testing. After reconstruction of the production DSM-LCC testing section, the affected DSM-LCC testing section will be subject to the compressive strength acceptance criteria as defined in this section.

L. AS-BUILT PLANS

Following completion of the production DSM column construction, the Contractor shall furnish to the Engineer a set of as-built plans detailing the locations of the DSM columns in terms of project coordinates, top and bottom elevations, QC compressive strength testing results, and any other dimensions of the DSM columns that are pertinent to the project.

M. MEASUREMENT AND PAYMENT

DSM constructed using group columns spacing (GCS) will be measured per linear foot of DSM column constructed and then accepted by the Engineer. DSM constructed using block column spacing (BCS) will be measured by the total neat-line ground improved volume (in cubic yards) accepted by the Engineer, where the neat-line is the rectangular plan area of the required ground improvement zone times the specified improvement depth. Material located outside of the tolerances specified will not be measured. Material used to remix an area found to be unacceptable to the Engineer will not be measured. The test section(s) will not be measured, and is considered incidental to the production DSM ground improvement.

Payment will be made at the unit contract price per linear feet for DSM constructed using group columns spacing (GCS) and per cubic yard for DSM constructed using block column spacing (BCS). Payment for DSM columns will be full pay to perform the work as specified including construction and testing of test sections, QC testing, construction and removal of surcharges and berms, handling and hauling of excavated spoils, and site cleanup.

Payment will be made under:

EXHIBIT 5 – SPECIAL PROVISIONS AND CONTRACT REQUIREMENTS

Item No.	Pay Item	Pay Unit
2051201	GROUND IMPROVEMENT (DEEP SOIL MIXING SOIL-CEMENT COLUMNS – BCS)	CY
2051202	GROUND IMPROVEMENT (DEEP SOIL MIXING SOIL-CEMENT COLUMNS - GCS)	LF
2051203	GROUND IMPROVEMENT (DEEP SOIL MIXING LIME-CEMENT COLUMNS- BCS)	CY
2051204	GROUND IMPROVEMENT (DEEP SOIL MIXING LIME-CEMENT COLUMNS- GCS)	LF

(43) SECTION 205: GROUND MODIFICATION – COMPACTION GROUTING COLUMNS:

June 28, 2013

A. GENERAL

1. Scope:

The work under this Section consists of furnishing all supervision, labor, material, equipment, and related services necessary to perform ground improvement by the compaction grout technique as indicated on the Contract Drawings and specified herein.

For this project, the purpose of the compaction grouting is to reinforce the loose sand layers below embankments. The compaction grouting will serve to reinforce loose sand in the event of liquefaction during an earthquake.

The work includes the delivery and placement of all concrete/grout material necessary for compaction grouting construction.

2. Compaction Grout Column Construction

The work is to be accomplished using specifically-designed equipment for compaction grouting. The drill is to be advanced to the specified compaction grouting depth. Concrete/grout shall then be injected through the drill pipe as the pipe is being withdrawn, in such a way as to exert a positive lateral pressure on the soil surrounding the concrete/grout filled grout hole.

3. Methods and Contractor Qualifications:

The Specialty Contractor performing the compaction grouting installation shall be one who can provide a minimum 3-year experience record documenting 5 recent, successful projects completed with these general site conditions and improvement criteria. References asserting this documentation shall be submitted with the bid.

A detailed description of the proposed construction method (including equipment and personnel) and the qualifications of the proposed Specialty Subcontractor shall be submitted with the bid.

4. References:

American Society for Testing and Materials (ASTM) Standards

American Concrete Institute (ACI) Standards

Prior to commencing work, the Contractor shall examine the site, drawings, records or existing utilities and other existing subsurface structures, and soil boring logs made available by the Engineer to help determine compaction grouting installation conditions.

Any subsurface data provided by the Department is provided solely as general information for convenience of Contractor. It is expressly understood that the Department, Engineer, or the Engineer's consultants will not be responsible for interpretations or conclusions drawn there from by the Contractor. The Department and Engineer expressly encourage the Contractor to perform soil test borings or other subsurface explorations to determine whether the Contractor's proposed ground modification method is capable of installing the specified compaction grout columns. Additional test borings and other exploratory operations may be made by the Contractor at no additional cost to the Department.

5. Submittals:

The following data shall be submitted for the approval of the Engineer prior to beginning of work.

- a. A detailed written procedure to be followed in installing the compaction grout columns and confirming that the specified work requirements have been achieved. The written procedure shall include a detailed description of the specialized equipment to be used.
- b. Proposed compaction grout design mix and descriptions of materials to be used. These shall be in sufficient detail to indicate their compliance with the specifications and either 1.) Laboratory tests of trial mixes made with the proposed mix or 2.) Laboratory tests of the proposed mix used on previous projects.
- c. The Contractor shall be responsible for providing all lines and grades for compaction grouting, including locations of all utilities and surveying markers.
- d. The Contractor shall be responsible for all health and safety requirements including those associated with the handling and disposal of contaminated materials. The Contractor shall be responsible for providing written procedures including a Health and Safety Plan.

6. Site Preparation:

The Contractor shall ensure a firm base on which heavy equipment can be operated safely under its own power.

The Contractor shall accurately locate all compaction grout columns in accordance with approved drawings. Compaction grouting shall be adjusted, as approved by the Engineer, to avoid utilities, foundations, and all other underground construction.

The Contractor shall provide access and maintenance thereof, for the compaction grouting equipment, work force and delivery of materials to the work site.

B. PRODUCTS

1. Materials:

- a. Portland Cement: Portland Cement shall conform to current ASTM standards, designation C 150. The use of cement replacement materials will be permitted subject to the approval of the Engineer and provided that they can be shown to have beneficial effects on concrete impermeability, heat generation during setting and general durability. The mix proportions of use shall be approved. For onsite batching, all cement and cement replacement materials shall be stored in separate containers according to type in waterproof stores or silos.
- b. Mineral Admixture: Mineral admixture, if used, shall be flyash or natural pozzolan which possesses the property of combining with the lime liberated during the process of hydration of Portland Cement to form compounds containing cementitious properties. The material shall conform to ASTM C 618, Class C or Class F.
- c. Fluidifier: Fluidifier shall be a compound possessing characteristics which will increase the fluidity of the mixture, act as water reducing agent and retardant.

- d. Water: Water shall be potable, fresh, clean and free of sewage, oil, acid, alkali, salts or organic matter.
- e. Fine Aggregate: Sand shall meet the requirements of current ASTM standards, designation C 33.

2. Grout Mixes:

The concrete/grout mix shall consist of Portland cement, sand, and water, and may also contain a mineral admixture and approved fluidifier. The components shall be proportioned and mixed to produce a concrete capable of maintaining the solids in suspension, which may be pumped without difficulty. These materials shall be proportioned to produce a hardened concrete/grout which will achieve the design strength within 28 days. The design 28-day concrete strength for this project shall be 2500 psi.

All materials shall be accurately measured by volume or weight as they are fed to the mixer. Time of mixing shall be not less than one minute at the site. If agitated continuously, the concrete/grout may be held in the mixer or agitator for a period not exceeding two and one half hours at concrete temperatures below 70 degrees F and for a period not exceeding two hours at higher temperatures, not exceeding 100 degrees F. Concrete/grout shall not be placed when its temperature exceeds 100 degrees F.

Protect concrete/grout from physical damage or reduced strength which could be caused by frost, freezing actions or low temperatures or from damage during high temperatures in accordance with ACI 305/306.

The concrete/grout mix shall be tested by making a minimum of six 2-inch cubes for each day during which compaction grouting is performed. A set of six cubes shall consist of two cubes to be tested at seven days, and two cubes to be tested at 28 days and two cubes held in reserve. Test cubes shall be cured and tested in accordance with ASTM C 109. Test the flow of each batch of concrete mix.

3. Concrete/Grout Testing:

- a. Sampling: Concrete/grout for the columns shall be sampled in accordance with ACI standards.
- b. Workability: The workability of concrete/grout shall be determined by the slump test as described in ACI standards or by an alternative approved method.
- c. Cube Tests: For each mix design of concrete, six cubes shall be made from a single batch when required for 65 cy of concrete/grout or part thereof in each day's work. Testing shall be carried out by an independent and approved laboratory. Two cubes shall be tested at an age of 7 days, two at 28 days, and two cubes shall be held in reserve for further testing, if required. Alternatively, cubes may be tested in accordance with an approved accelerated testing regime. The Contractor shall submit certified copies of the results of all tests to the Engineer.
- d. Standard of Acceptance: The standard of acceptance of the concrete mix cubes shall be in accordance with ACI standards or as otherwise approved.
- e. Record of Tests: The contractor shall keep a detailed record of the results of all tests on concrete/grout and concrete materials. Each test shall be clearly identified with the columns to which it relates.

4. Batching Concrete/Grout:

- a. General: Facilities shall be provided for the Engineer to inspect the concrete/grout mixing plant or plants when requested. Unless otherwise specified the requirements in Clauses 2.5.2, 2.5.3, 2.5.4 shall be met.

- b. Accuracy of Weighing and Measuring Equipment: The weighing and water-dispensing mechanisms shall be maintained at all times to within the limits of accuracy described in ACI standards.
- c. Tolerance in Weights: The weights of the quantities of each size of aggregate and of cement shall be within 2% of the respective weights per batch after due allowance has been made for the presence of free water in the aggregates, which shall be determined by the Contractor by an approved method.
- d. Moisture Content of Aggregates: The moisture content of aggregates shall be measured immediately before mixing and as frequently thereafter as is necessary to maintain consistency of mix.

5. Mixing Concrete/Grout

- a. Type of Mixer: The mixer shall be of the batch type, specifically designed for concrete/grout mixing.
- b. Tolerance of Mixer Blades: The mixing blades of pan mixers shall be maintained within the tolerances specified by the manufacturers of the mixers, and the blades shall be replaced when it is no longer possible to maintain the tolerances by adjustment.
- c. Cleaning of Mixers: Mixers which have been out of use for more than 30 minutes shall be thoroughly cleaned between the mixing of different types of cement
- d. Minimum Temperature: The temperature of fresh concrete/grout shall not be allowed to fall below 37° F. No frozen material or materials containing ice shall be used. Newly cast columns are to be covered to protect them against freezing unless the final cut off level is at least 0.8 ft. below the final head level as cast. Where a column is cast in frozen ground, appropriate precautions shall be taken to protect any section of the column in contact with the frozen soil where this occurs below the cut off level.

6. Transporting Concrete/Grout

- a. Method of Transporting: The method of transporting concrete/grout shall be submitted for approval. Concrete/grout shall be transported in uncontaminated watertight containers in such a manner that loss of material and segregation are prevented.
- b. Pumping Concrete/Grout: Pumped concrete/grout complying with this Specification may be used. The methods employed in its use shall be subject to approval.

7. Ready-mixed Concrete/Grout

- a. Conditions of Use: Subject to approval, the Contractor may use ready-mixed concrete/grout in accordance with ACI standards. Approval shall be obtained for each proposed use of ready-mixed concrete/grout in different sections of the Works and for each different mix, which shall comply with this Specification.
- b. Mixing Plant: Unless otherwise agreed by the Engineer, truck mixer units and their mixing and discharge performance shall comply with the requirements of ACI standards.

C. EXECUTION

1. General

The Compaction grout column technology employs a drill stem for both penetration and maintaining borehole stability. The concrete/grout is pumped into the column from the base of the drill stem. All materials and work shall be in accordance with Sections A, B and C of this Specification.

2. Layout

The procedure for layout of columns and checking their positions shall be approved by the Engineer. The actual compaction grout columns shall be installed within 3 inches of the

EXHIBIT 5 – SPECIAL PROVISIONS AND CONTRACT REQUIREMENTS

design location shown on the Drawings, approved shop drawings or as otherwise directed by the Engineer.

3. Diameter of Columns

The diameter of a column shall be not less than 24-in.

4. Equipment

The contractor shall use a drill rig capable of penetrating all necessary soil layers or obstructions.

5. Penetration

- a. Penetration Near Recently Cast Columns: Columns shall not be advanced so close to other columns which have recently been cast and which contain workable or unset concrete/grout that a flow of concrete could be induced from or damage caused to any of the columns. A minimum distance of 8 ft (center-to-center) shall be kept between columns less than 24-hours old and on-going column installations.
- b. Removal of Drill Pipe from the Ground: Drill Pipe shall not be extracted from the ground during the penetration or construction of a column in such a way that an open unsupported void or inflow of water into the column section would result.
- c. Depth of Columns: Any failure of a column to reach the required depth, as given in the Specification or shown on the Drawings, shall be reported to the Engineer without delay and a full statement of the reasons given.

6. Placing of Concrete/Grout

- a. Mix Design and Workability: Where not otherwise stated in this Section, the concrete shall comply with Section B of this Specification. The design and workability of concrete to be used in the formation of a column shall produce a mix which is suitable for pumping. It shall have a target slump of 4 to 6 inches unless otherwise approved and a minimum cement content of 580 lbs/yd³. The fine aggregate shall be in accordance with ACI standards. This mix shall be designed so that segregation does not occur during the placing process, and bleeding of the mix shall be minimized.
- b. Equipment for Supply of Concrete/Grout to Columns: Concrete/Grout shall be supplied to the column through suitable tubing and hoses.
- c. Commencement of Concrete/Grout Supply to Each Column: The technique and equipment used to initiate and maintain the concrete flow shall be such that a column of the full specified cross-section is obtained from the maximum depth to the final cut off level.
- d. Rate of Supply of Concrete/Grout: The concrete/grout shall be supplied to the column at a sufficient rate during drill pipe withdrawal to ensure that a continuous monolithic shaft of the full specified cross-section is formed, free from debris or any segregated concrete/grout. The rate of withdrawal of the drill pipe and pressures of concrete/grout shall be measured and recorded throughout the phase of vibrator withdrawal for each column. The Contractor shall submit proposals for his method of monitoring construction for approval prior to the commencement of the Works.
- e. Completion of Columns: If the concrete/grout placing in any column cannot be completed in the normal manner, then the column shall be re-penetrated before concrete/grout has hardened and shall be completely replaced.
- f. Casting Level of Column Head: Concrete shall be cast to the commencing surface level or slightly above unless otherwise specified
- g. Disposal of Contaminated Material: The Contractor is responsible for disposal of all excavated soil, excess water, and spoil generated during installation of the compaction

grouting installation at no extra cost. Manifests necessary for waste disposal shall be executed by the Engineer.

7. Cutting of Column Heads

When cutting off and trimming columns to the specified cut off level, the Contractor shall take care to avoid shattering or otherwise damaging the rest of the column. Any laitance, or contaminated, cracked or defective concrete/grout shall be cut away and the column made good in an approved manner to provide a full and sound section up to the cut off level.

8. Documentation:

Any proposed change in the approved construction program, necessitated by a change in the subsurface conditions, shall be submitted in writing to the Engineer for approval.

A daily log shall be submitted to the Engineer by the Contractor to include hole number, start/finish time of treatment, depth of treatment, diameter of drill hole, description of soil penetrated, and volume of grout/concrete placed at depth in no more than 2-ft increments.

D. CONSTRUCTION

The compaction grout columns shall be constructed prior to bridge foundations. Positive site drainage shall be established prior to construction of compaction grouting. Contractor shall control all spoils generated during compaction grouting and prevent spoils from flowing offsite. Spoils generated by compaction grouting shall be disposed of properly and removed from the site by the Contractor. No additional compensation shall be made for handling spoil.

Compaction grouting columns shall be constructed to the lines and elevation shown on the plans, and in accordance with the Special Provisions.

Compaction grout columns shall extend from the existing ground surface to the elevations outlined in the plans. No payment will be made for compaction grout columns installed within areas that are later excavated. The contractor shall be responsible to construct compaction grout columns to the depths required, and shall use the methods necessary to penetrate to the required depth, including but not limited to drilling through stiff and dense layers that may be present, as well as obstructions from existing construction.

The compaction grout columns shall be installed to the minimum required Area Replacement Ratio. The required minimum area replacement ratio (A_r) achieved at any depth by the compaction grouting shall be that which is equivalent to the diameter of the grout columns at the center-to-center (c-c) spacing shown in the plans and on a triangular pattern. The area replacement ratio shall be defined by the following relationships:

$$A_r = \frac{\text{Column Area}}{\text{Tributary Area}} \times 100\%$$

Tributary Area

Where: Column Area = Area of circle based on column diameter as defined below.

Tributary Area = $0.866 (\text{Column Spacing})^2$ for triangular spacing.

Acceptance of the constructed column will be based on the theoretical column diameter determined from the volume of concrete/grout installed.

The Contractor shall, at all times, protect structures, underground utilities and other construction from damage caused by grouting operations. Damaged material shall be replaced or repaired to the satisfaction of the Engineer at no additional cost to the Department.

EXHIBIT 5 – SPECIAL PROVISIONS AND CONTRACT REQUIREMENTS

E. METHOD OF MEASUREMENT

The bid item for compaction grouting shall include the delivery and placement of all concrete material necessary for compaction grout column construction. It shall also include disposal of all spoil (surface water, soil, etc.) in a manner acceptable to the Department of Health and Environmental Control and to the Engineer.

F. BASIS OF PAYMENT

The quantity of ground modification measured for payments shall be the actual length of the installed compaction grout columns acceptable to the Engineer. No payment will be made for ground modification beyond the limits required by the Contract Documents, unless such increases in the specified area are directed in writing by the Engineer.

The accepted quantity, measured as above, will be paid for at the contract unit price per linear foot for compaction grout columns constructed at the diameter specified in the plans, which price and payment shall be full compensation for furnishing, hauling, treating, compacting of materials, removal of spoils and for all labor, equipment, tools, maintenance, and incidentals necessary to complete this item of work.

Payment will be made under:

Item No.	Pay Item	Pay Unit
8990353	GROUND MODIFICATION–COMPACTION GROUTING COLUMNS	Linear ft

(44) SECTION 305: MAINTENANCE STONE:

Maintenance Stone used on this project shall conform to the gradation requirements of Section 305, or to the gradation specified for Aggregate No. CR-14 in the Standard Specifications.

(45) SECTION 306: CEMENT MODIFIED RECYCLED BASE:

Replace Section 306.4.5 of the Standard Specifications and Section 306.4.6 of the Cement Modified Recycled Base (12/2010) Supplemental Specifications with the following:

- A. Before beginning compaction, ensure that the mixture is in a loose condition for its full depth. Continue compaction until the entire depth of the base course mixture is uniformly compacted to not less than 95% of the maximum density. At the discretion of the RCE, SC-T-26 or SC-T-25 Method C can be used to determine the maximum density of the composite mixture. If tests show that compaction is not being met, adjust construction operations to obtain the required density. Complete the compaction work within 2 hours from the initial rolling.
- B. After the mixture is compacted, reshape the surface of the base course as necessary to conform to the required lines, grades, and cross section. Perform light scarifying as required to obtain a uniform mixture and to prevent surface scaling.
- C. Thoroughly compact and finish the surface by rolling with an approved smooth wheel tandem roller, pneumatic-tired roller, or other means satisfactory to the RCE. Perform compacting and finishing operations that produces a smooth, closely knit surface, free from equipment imprints, cracks, ridges, or loose material. Maintain the moisture content of the surface of the surface material within 2% of the specified optimum moisture content during finishing operations.
- D. Use SC-T-26 for the maximum density and optimum moisture of the mixture initially and whenever practical. However, if compaction is not being met and proper construction methods are being applied, compaction is being achieved too easily, or a significant change in the material has occurred, the RCE will perform SC-T-25 Method C at his/her discretion to establish a new maximum density and optimum moisture. If SC-T-25 Method C is performed, samples will be taken from the full depth of the mixed layer.
- E. Verification of the maximum density will be performed by molding one point of SC-T-25 Method C near optimum moisture as defined by SC-T-26 (initial mixture design). If the maximum density of the material varies by more than 3.0 pcf then the RCE will continue running the additional 3 points to determine a new maximum density and optimum moisture.
- F. Per the discretion of the RCE, the contractor may provide Quality Control to perform testing under the direct supervision of the RCE or RCE representative.

(46) SECTION 401: ASPHALT BINDER ADJUSTMENT INDEX:

No liquid asphalt binder adjustments will be made on this Project.

(47) SECTION 401: DRESSING OF SHOULDERS:

Prior to the placement of asphalt mixtures on existing roadways, the contractor will be required to remove all vegetation adjacent to the edge of pavement which impedes the placement of the asphalt mixture to the specified width. The contractor shall also remove and dispose of all excess asphalt which is disturbed during minor grading for widening, or during removal of debris or grass from existing surface during preparation of surface for new lift. After the asphalt mixture has been placed, the contractor shall blade the disturbed material to the extent that the shoulder is left in a neat and presentable condition. All excess material shall be removed from the project. No direct payment shall be made for this work; all costs are to be included in the price of other items of work.

(48) SECTION 401: HOT MIX ASPHALT (HMA) QUALITY ASSURANCE:

Reference is made to the Supplemental Technical Specification “Hot Mix Asphalt (HMA) Quality Assurance.” For the purposes of applying this Supplemental Technical Specification, pay factor adjustments will be based on a unit price of \$75 per ton.

(49) SECTION 401: HOT-MIX ASPHALT RIDEABILITY:

Reference is made to the Supplemental Technical Specification “Hot-Mix Asphalt Rideability.” For the purposes of applying this Supplemental Technical Specification, pay factor adjustments will be based on a unit price of \$75 per ton.

(50) SECTION 401: FULL DEPTH ASPHALT PAVEMENT PATCHING:

A. DESCRIPTION:

The Contractor shall patch existing asphalt pavement at locations directed by the Engineer. This work shall consist of the removal of deteriorated pavement and replacing with a six (6) inch full depth asphalt plant mix patch.

B. CONSTRUCTION PROCESS:

The deteriorated pavement shall be removed to the width and length indicated by the RCE, with the face of the cut being straight and vertical. The pavement shall be removed to a depth of six (6) inches as directed by the RCE. In the event unstable material is encountered at this point, then such additional material shall be removed as directed by the RCE.

The volume of material removed below the patch shall be backfilled with crushed stone and thoroughly compacted in 4-inch layers with vibratory compactors. Prior to placing the asphalt patch material in the hole, the sides of the existing asphalt pavement shall be thoroughly tacked. The patch material shall then be placed in layers not exceeding 3 inches with each layer being thoroughly compacted with a vibratory compactor and pneumatic roller. The patch material shall be an approved SCDOT Asphalt Concrete Binder Course Mix. Patches shall be opened and filled in the same day. Asphalt mixture shall not be applied when the existing surface is wet or frozen. The finished patch shall be smooth riding. The patches are to be no less than six feet by six feet in size and should be spaced at not less than 25 feet between patches.

The quantity of full depth asphalt pavement patching to be paid for will be the actual number of square yards of existing asphalt pavement which has been patched and accepted. The work includes cleaning, removing, and disposing of debris from the patching work, furnishing and placement of crushed stone and asphalt patching material, and all other materials, labor, equipment, tools, supplies, transportation, and incidentals necessary to fulfill the requirements of this item of work.

The Contractor's bid shall include 150 square yards of (6) inch full depth asphalt pavement patching. If more than the estimated square yards of patching are required by SCDOT, the Contractor will be paid a unit price of \$45.00 per square yard. If less than the estimated square yards of patching are required by SCDOT, the Contractor shall reimburse SCDOT for the quantity of full depth patching that was not needed. Reimbursement will be paid to SCDOT at a unit price of \$45.00 per square yard.

(51) SECTION 403: PAVING UNDER GUARDRAIL:

August 17, 2011

Section 403 is expanded as follows:

A. GENERAL

Provide paving under guardrail as shown in the plans, in accordance with plan details and these special provisions. Pavement under guardrail shall only be placed where shown in the plans or as directed by the Engineer.

B. MATERIALS

Pavement material under guardrail shall be the same as the hot mix asphaltic concrete surfacing being used on the adjacent roadway. Liquid asphalt binder shall be the same as that used for paving on the adjacent roadway.

Low-density Flowable Fill with a maximum 28-day compressive strength of 120PSI shall be used to fill leave out areas.

C. CONSTRUCTION

Place hot mix asphaltic concrete surfacing under guardrail in accordance with Section 401 of the Standard Specifications where indicated on the plans or as directed by the Engineer. Refer to details provided in this special provision for typical limits of paving and requirements for leave out areas around guardrail posts.

EXHIBIT 5 – SPECIAL PROVISIONS AND CONTRACT REQUIREMENTS

Pave area between the edge of pavement and the face of the guardrail when that distance is less than 20 feet.

Extend paving under guardrail to bridge end at locations where concrete approach slabs are used.

When at least one opening between parallel lines of guardrail is less than 20 feet wide, pave the entire area between the lines of guardrail.

When openings between parallel lines of guardrail are more than 20 feet wide, but obstructions such as bridge columns reduce the access between the guardrail and the obstruction to less than 20 feet and/or the distance between any two obstructions is less than 20 feet then the area with any single point of access less than 20 feet wide shall be paved.

When areas around obstructions are paved, no area should remain unpaved that will sustain plant life.

The top of pavement shall be constructed to be flush with surrounding earth shoulders and slopes.

Damage to pavement during subsequent construction, especially during driving of guardrail posts, should be minimized. Any damaged pavement must be restored to its original line and grade to the satisfaction of the Engineer.

Leave outs shown in the details shall be either formed or sawcut.

D. MEASUREMENT AND PAYMENT

Hot mix asphalt surface course shall be measured and paid for in accordance with Section 401 of the Standard Specifications.

Liquid asphalt binder shall be measured and paid for in accordance with Section 401 of the Standard Specifications.

When additional excavation is required to obtain the depth of pavement specified, this additional excavation will be measured separately and paid for by the cubic yard as unclassified excavation in accordance with section 203 of the Standard Specifications.

When borrow is needed to construct the area to be paved to meet the typical section, this borrow excavation will be measured and paid for separately as borrow excavation in accordance with section 203 of the Standard Specifications.

The costs to provide the leave outs shall be considered incidental to the hot mix asphalt surface course and no separate measurement or payment shall be made for providing leave out areas.

Flowable fill for leave out areas will be measured and paid for in accordance with section 210 of the Standard Specifications.

Payment under this section will include the following:

EXHIBIT 5 – SPECIAL PROVISIONS AND CONTRACT REQUIREMENTS

Item No.	Pay Item	Unit
2031000	UNCLASSIFIED EXCAVATION	CY
2033000	BORROW EXCAVATION	CY
2103000	FLOWABLE FILL	CY
40110XX	LIQUID ASPHALT BINDER PG__-22	TON
40303XX	HOT MIX ASPHALT CONCRETE SURFACE COURSE TYPE _	TON

EXHIBIT 5 – SPECIAL PROVISIONS AND CONTRACT REQUIREMENTS

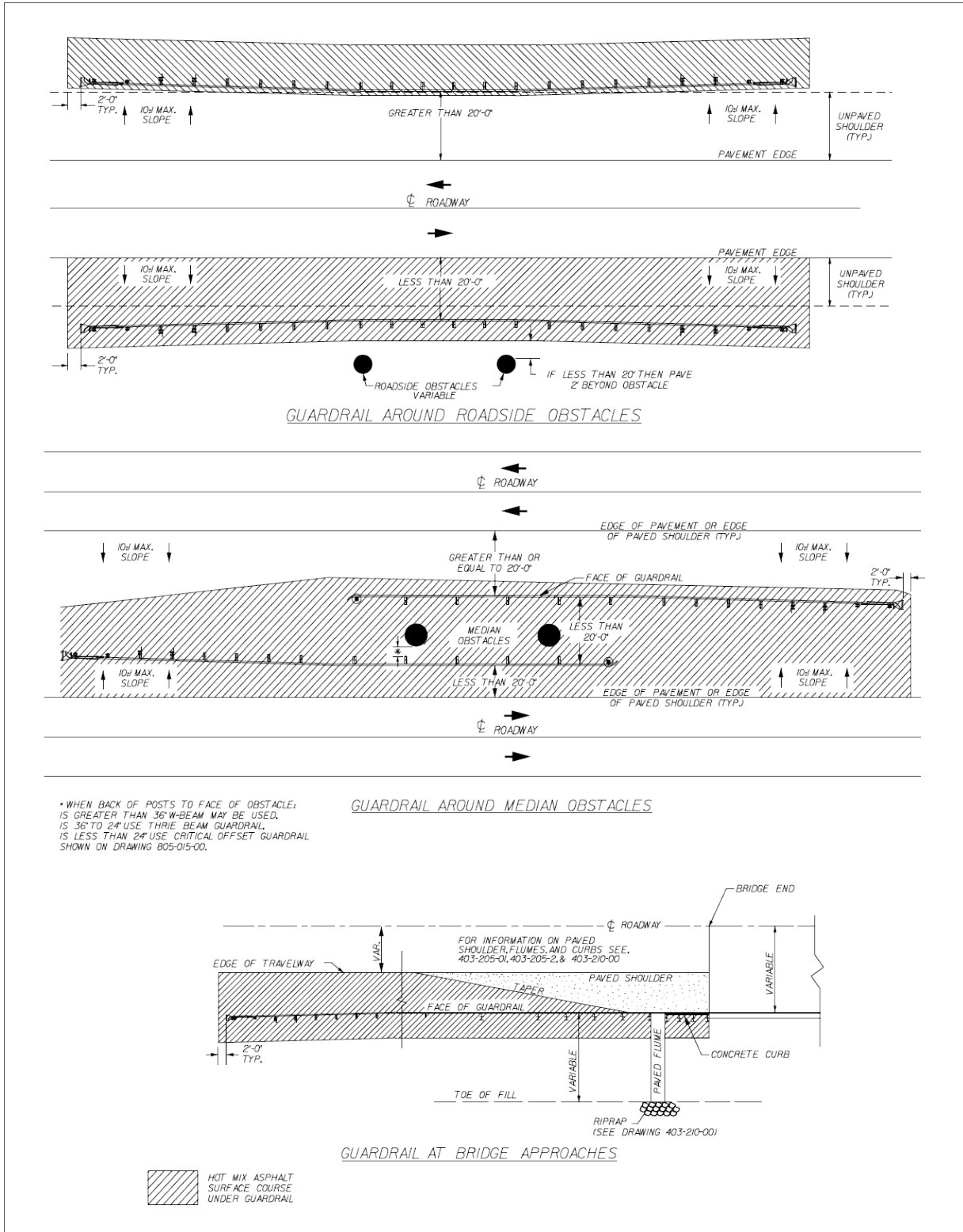

EXHIBIT 5 – SPECIAL PROVISIONS AND CONTRACT REQUIREMENTS

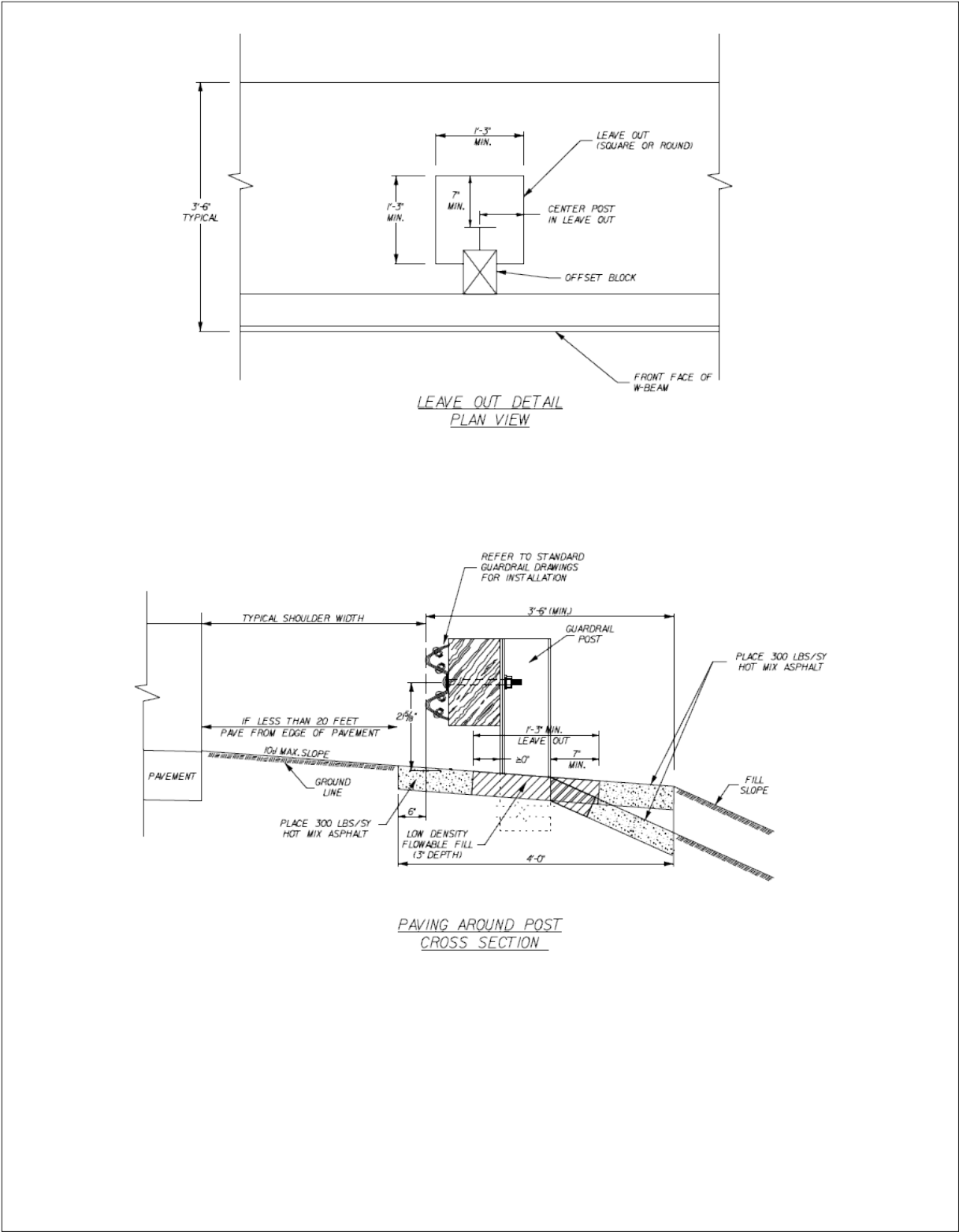

EXHIBIT 5 – SPECIAL PROVISIONS AND CONTRACT REQUIREMENTS

(52) SECTION 403: WARM MIX ASPHALT – ASPHALT INTERMEDIATE COURSE TYPE B (SPECIAL):

WMA Intermediate B Special will utilize the same specifications for Intermediate B with several exceptions:

- A. The mix must use WMA Technology using a chemical process on QPL # 77 to utilize maximum reduction in temperature to improve constructability in the field placement operations.
- B. The mix will require the exact same requirements as stated in SC-M-402 with exception of target air voids. The air voids will be targeted at 2.5-3.0% on the mix design to increase binder content and improve field compaction and fatigue resistance.
- C. The placement rate will also be different than conventional mix in order to make necessary repairs to the milled pavement sections during one lane closure sequence.
- D. In place density will be measured and accepted by using the gauge in lieu of taking roadway cores. A test strip will be required on the shoulder of the roadway to set up a roller pattern and establish target density. Ensure in place density is acceptable by taking 6 inch roadway cores at the end of the test strip to verify maximum compaction effort is obtained. All other mix acceptance testing will follow SC-M-400 using the same mixture acceptance criteria as the Intermediate Course Type B.

Item No.	Pay Item	Unit
4112320 X	WMA INTERMEDIATE COURSE TYPE B "SPECIAL"	TON

(53) DIVISION 600: FURNISH AND INSTALL DETECTOR LOOPS:

The Contractor is hereby notified that All Catalog descriptions and documentation are to be submitted within (5) days after the bid openings to the Contracts Administrator.

The loops shall be installed in the surface course on all projects in Engineering Districts 3, 4, 5, 6, & 7.

The loops shall be installed in the binder course for all projects in Engineering District 1.

The loops shall be on installed in the binder course on new construction projects, and in the surface for resurfacing projects in Engineering District 2.

(54) DIVISION 600: MANUAL ON UNIFORM TRAFFIC CONTROL DEVICES:

The Contractor is advised that all work involving design or installation of traffic control devices, including but not limited to signs, pavement markings, elements of work zone traffic control, signals, etc., shall be in compliance with the FHWA’s Manual on Uniform Traffic Control Devices (MUTCD), latest edition. The latest edition is defined as the edition that the Traffic Engineering Division of SCDOT recognizes as having been officially adopted (Engineering Directive, Memorandum 19) at the time the project is let, unless stated otherwise in the Special Provisions.

(55) DIVISION 600: EVALUATION OF RETROREFLECTIVITY:

Within 20 days of initial application, the Contractor shall arrange for an independent party to evaluate the retroreflectivity of the pavement markings using a mobile retroreflectometer utilizing 30 meter CEN geometry. All lines shall be measured in both directions. The independent party conducting the measurements shall furnish directly to the Department a report detailing the average of the readings over one mile segments for each type of long line (white edgeline, white lane lines, yellow edgelines) along the length of the project. Average measurements shall also be provided along each ramp. Interstate mile markers may be used for beginning and ending points, with the first and last segments in each direction being less than one mile in length. The initial minimum retroreflectivity values shall be as follows:

Retroreflectivity (mcd/lux/m²)

EXHIBIT 5 – SPECIAL PROVISIONS AND CONTRACT REQUIREMENTS

<u>White</u>	<u>Yellow</u>
450	350

A second evaluation shall take place within 20 days prior to the end of the 180 day observation period. The evaluation method shall be the same as described above. The 180 day minimum retroreflectivity values shall be as follows:

Retroreflectivity (mcd/lux/m²)

<u>White</u>	<u>Yellow</u>
400	300

All markings failing to meet the initial minimum retroreflectivity requirements by more than 50 mcd / lux / m² shall be replaced immediately at the Contractor's expense. All markings failing to meet initial requirements by less than 50 mcd / lux / m² may be reevaluated at the time of the 180 day evaluation unless the defect causing the lower readings is obvious to the Engineer.

(56) SECTION 601: PENALTY FOR VIOLATING LANE CLOSURE RESTRICTIONS:

The Contractor is advised that the Lane Closure Restrictions outlined in the Traffic Control Special Provisions will be strictly enforced. Should lane closures remain in place or not be completely removed by the time specified in the Traffic Control Special Provisions, a penalty will be assessed at the rate of **\$2,500.00 (Two Thousand Five hundred Dollars)** for each 1/4 hour interval (or any portion thereof). Should lane closures remain in place or not be completely removed for a period of longer than one hour beyond the time specified by the Traffic Control Special Provisions the penalty will increase to **\$5,000.00 (Five Thousand Dollars)** for each 1/4 hour interval (or any portion thereof).

(57) SECTION 605: PERMANENT CONSTRUCTION SIGNS:

Utility locations must be performed prior to the placement of Permanent Construction Signs. State Law requires that the location of each sign be marked with a white line in the roadway or a stake in the shoulder. The locator company will mark 25 feet on either side of the location. The responsibility for marking the sign locations prior to the contractor calling **PUPS SC811** for utility locate lies with the party responsible for lines and grades on the project. If Construction Lines and Grades is a pay item, then the Prime Contractor is responsible for marking the sign location. If this is not included, it is the Department's responsibility to mark the locations.

Prior to marking the sign location, care must be taken when marking the signs to ensure that there are no obstructions or other mitigating factors that will cause the sign to be moved outside of the 50 foot utility window. Any costs associated with staking out the sign locations are considered incidental to the cost of Permanent Construction Signs.

Requests for utility locates must be specific and isolated to the sign locations if no ground disturbing activities are occurring outside of the sign placement.

(58) SECTION 610: WORK ZONE TRAFFIC CONTROL PROCEDURES:

The first sentence of Section 610.3 of the 2007 Standard Specifications is hereby revised to:

“Ensure that background color of personal protective apparel is either fluorescent Yellow-Green or fluorescent Orange-Red, and meets ANSI Standard 107-2004 National Standard for High Visibility Apparel Class 2 (or Class 3 as necessary) Performance Criteria, or latest edition.”

Note #12 of Standard Drawing 610-005-00 is hereby revised to:

“During nighttime flagging operations, flaggers shall wear a Safety Vest and Safety Pants meeting ANSI Standard 107-2004 National Standard for High Visibility Apparel Class 3

Performance Criteria, or Latest Edition, and a Hardhat. The color of the apparel background material shall be either fluorescent Yellow-Green or fluorescent Orange-Red.”

(59) SECTION 653: RETROREFLECTIVE SIGN POST PANELS:

Section 653 is hereby modified as follows:

A. 653.2 MATERIALS

Add the following paragraph:

Use retroreflective sign post panels constructed of a nonmetallic composite or 3mm aluminum composite material approved by the SCDOT covered with a 3-inch wide type III sheeting. Use sheeting that meets the requirements of Section 651.2.3. Use approved panels included on the Approved Products List For Traffic Control Devices in Work Zones.

B. 653.4.2 ERECTION

Add the following paragraph:

Mount the panel for the full length of the post from the sign to within 6 inches above the edge of the roadway. Mount panel only on post specified in the plans or special provisions. Secure the panel to the post with a minimum of 3 5/16-inch bolts and a lock washer and flat washer between post and nut, or tamper-resistant and rust-resistant screws. Use bolts, washers and nuts meeting the requirements of section 651.2.2. Provide the sheeting in the color that matches the background color of the sign except that the color for the “Yield” and “Do Not Enter” signs shall be red. Install panels to both posts, if there are two posts supporting the sign.

C. 653.5 MEASUREMENT

Replace with the following:

653.5 Measurement

The quantity for the pay item U-Section Post for Sign Support – (2 or 3)P, U-Section Post for Sign Bracing –2P or retroreflective sign post panel is the length of U-section post used for sign support or bracing or panel and is measured to the nearest 1/100 of a linear foot (LF) of the required post or panel, complete and accepted.

D. 653.6 PAYMENT

Replace with the following:

653.6 Payment

Payment for the accepted quantity for U-Section Post for Sign Support – (2or 3)P, U-Section Post for Sign Bracing –2P or Retroreflective Sign Post Panel, measured in accordance with Subsection 653.5, is determined using the contract unit bid price for the applicable pay item, and the payment includes all direct and indirect cost and expenses necessary to complete the work.

Payment is full compensation for fabricating and erecting U-section posts or braces or panels as specified or directed and includes providing mounting hardware; removing and disposing of existing signs supports, braces, and mounting hardware removed or replaced; replacing or relocating supports or braces shown on the Plans or directed by the RCE; and all other materials, labor, equipment, tools, supplies, transportation, and incidentals necessary to fulfill the requirements of the pay item in accordance with the Plans, the Specifications, and other terms of the Contract.

Pay items under this section include the following:

EXHIBIT 5 – SPECIAL PROVISIONS AND CONTRACT REQUIREMENTS

Item No.	Pay Item	Unit
6531205	U-SECTION POST FOR SIGN SUPPORTS – 2P	LF
6531210	U-SECTION POST FOR SIGN SUPPORTS – 3P	LF
6531215	U-SECTION POST FOR SIGN BRACING – 2P	LF
6531500	REFLECTIVE SIGN POST PANELS	LF

(60) DIVISION 700: ANTI-GRAFFITI COATING:

July 27, 2015

E. GENERAL

The anti-graffiti coating system shall be applied to locations as described in Exhibit 4 and in accordance with this Specification. Anti-graffiti coatings intended for use under this Specification shall be of a composition capable of preventing the adhesion of and facilitating the removal of acrylic, polyurethane, and alkyd spray paint. Use a clear, non-sacrificial anti-graffiti coating for all applications.

F. MATERIALS

All anti-graffiti coatings must possess the physical and handling characteristics that are compatible with the requirements of this Specification. Anti-graffiti coating shall be manufactured by one of the approved manufacturers listed on the most recent Qualified Product List 7, titled “Qualified Spray-On/Brush-On Surface Coatings for Concrete Finish”. Contractor shall ensure that the anti-graffiti coating is compatible with the selected applied Finish Coating, if applicable.

Anti-graffiti coatings shall contain less than 5.0 lb/gal volatile organic compounds (VOC) as defined by 40 CFR Part 59, Subpart D. The manufacturer shall supply the following additional information:

9. Technical data sheet that includes installation instructions and graffiti removal instructions, including any solvents or other materials, as necessary. Graffiti removal must be accomplished with nonproprietary cleaners as defined in ASTM D 6578.
10. Certification that non-sacrificial anti-graffiti coating shall not blister, crack, check, chalk, delaminate, or exhibit a color change of more than 8 dE94 (or dE76) CIELAB units for a period of one year after installation.

Clear coating must contain a UV degradable color for inspection purposes. UV degradable color must dissipate in a reasonable time period to allow inspection but not detract from visual impact of the structure.

Additionally, submit a certification that the coating meets the following laboratory performance requirements:

Additional Laboratory Performance and Tests		
Test	Method	Limits
Graffiti Resistance	ASTM D 6578; Use identified marking materials; initial and re-cleanability; and after exposure initial and re-cleanability	Cleanability Level 1, 2, or 3
Fluid Resistance	ASTM D 1308; Paint thinner, gasoline	No blistering, discoloration, softening, or adhesion loss

G. APPLICATION

Apply an anti-graffiti coating or coating system in accordance with manufacturer’s product data sheet and as specified herein, when the ambient temperature is between 40° and 90°F, and the surface temperature is between 50° and 85°F and rising.

Ensure all concrete has cured a minimum of 30 days before applying anti-graffiti coating. Do not apply coating when precipitation is expected within 12 hours of the completion of application or the relative humidity is above 88%.

H. PROTECTION OF ADJACENT SURFACES

Consider wind direction, velocity and geographic location as having a major impact on all cleaning and anti-graffiti coating operations. Use all necessary precautions to prevent cleaning and anti-graffiti coating materials from being dispersed outside the work site. If conditions are such that material is dispersed to areas where vehicles or other property may be damaged, suspend operations until conditions improve and work can continue without affecting adjacent property.

Protect all surfaces not intended to be coated, which are adjacent to, or in close proximity to the surfaces to be coated, during the application of anti-graffiti coating. Clean surfaces that are to be coated, as per the manufacturer's product data sheet.

I. SURFACE PREPERATION

Prior to applying any anti-graffiti coatings, prepare all surfaces to be coated in accordance with ASTM D 4261 or ASTM D 4258 and the manufacturer's product data sheet. When the anti-graffiti coating or coating system is to be applied over an existing coating, apply a test patch (minimum area of 4 square feet) in accordance with this Specification. Allow the test patch to cure a minimum of 7 days without any defects. No time extension will be granted as a result of this test requirement.

J. BASE COAT

Apply the base coat, if part of the system, as specified by the manufacturer. Unless otherwise specified by the manufacturer, ensure the cured base coat has a minimum dry film thickness of 4.0-8.0 mils.

K. FINISH COAT

When applicable, ensure the base coat surface is clean and cured to a dry hard state according to the manufacturer's instructions before applying the finish coat. Mix finish coat and apply in accordance with the manufacturer's instructions. Ensure the cured finish coat of the two coat system has a minimum dry film thickness of 2.5-5.0 mils. Apply as many coats as necessary to provide a finish coat which is a uniform continuous film over the entire surface, free of pinholes, runs, sags, or any other deficiencies. Finish coat shall be considered "non-sacrificial".

L. CORRECTION OF DEFICIENCIES

Remove all applied anti-graffiti coatings identified by the Engineer as damaged, defective, or otherwise not meeting these Specifications, in accordance with the manufacturer's recommendations. Prepare the surface and reapply the coating in accordance with the manufacturer's recommendations and as specified herein, at no additional cost to the Department.

M. REMOVAL OF GRAFFITI BEFORE ACCEPTANCE

Remove all graffiti from areas receiving anti-graffiti coating, at no additional cost to the Department. Ensure all federal, state, and local environmental regulations are met when removing graffiti. Removal shall be in accordance with manufacturer's recommendations.

(61) SECTION 701: SAND LIGHTWEIGHT CONCRETE:

Use sand lightweight concrete, where specified in the plans, complying with the requirements of this Special Provision.

Sand lightweight concrete is composed of portland cement, fine aggregate, lightweight coarse aggregate, water, and admixtures. Provide sand lightweight concrete that complies with the

EXHIBIT 5 – SPECIAL PROVISIONS AND CONTRACT REQUIREMENTS

applicable requirements of Section 701 of the Standard Specifications and the additional requirements herein.

At least 35 days prior to the proposed use, submit for approval a mix design from a testing laboratory accredited by the AASHTO Accreditation Program. Provide a mix that obtains a 28-day design compressive strength equal to or greater than 4000 psi and satisfies the following design criteria:

TEST	TEST METHOD	REQUIREMENT
Max. Unit Weight, plastic, lbs/ft ³	AASHTO T 121	120
Max. Unit Weight, dry, lbs/ft ³	ASTM C567 using equilibrium (air dried) unit weight	115
Min. Relative Dynamic Modulus, (percent)	AASHTO T 161 Procedure A	80

When submitting the mix design, include the source of the aggregates, cement, and admixtures and the gradation, specific gravity, and fineness modulus (fine aggregate only) of the aggregates. Submit test results showing the mix design conforms to the criteria, including the 28 day compressive strength of a minimum of six cylinders. Provide a mix design that produces an average compressive strength sufficient to ensure that a minimum strength of 4000 psi is achieved in the field.

Produce an additional mix in accordance with AASHTO M 195 to determine the drying shrinkage. The maximum drying shrinkage for this mix is 0.07%.

For lightweight coarse aggregate, use expanded shale or slate that meets the requirements of AASHTO M 195. Provide lightweight coarse aggregate that meets the gradation table below.

GRADATION OF LIGHTWEIGHT CONCRETE AGGREGATE	
Sieve Size	Passing Square Opening Sieves (Percent by Weight)
1"	100
3/4"	90-100
3/8"	10-50
No. 4	0-15

Determine the soundness in accordance with AASHTO T 104. Loss of more than 10% of the lightweight aggregate in five cycles of the accelerated soundness test using sodium sulfate is not permitted.

Ensure the lightweight aggregate will have a wear of not more than 40% when tested in accordance with AASHTO T 96.

Ensure that lightweight aggregate has an absorbed moisture content equal to the 24 hours absorption as determined by AASHTO T 84 or T 85 when it is proportioned and incorporated into the mix. Consult with the lightweight aggregate supplier regarding minimum absorption required for proper performance of aggregate in concrete mixtures.

Have a representative from the manufacturer of the lightweight aggregate attend and participate in the Pre-pour Conference and also provide technical assistance in the production of the lightweight concrete at the batch plant and/or site for the first day of lightweight concrete mixing and placement operations.

Do not use AASHTO T 152 to determine the air content. Determine air content in accordance with AASHTO T 196.

EXHIBIT 5 – SPECIAL PROVISIONS AND CONTRACT REQUIREMENTS

Determine the plastic density (unit weight) of lightweight concrete in accordance with AASHTO T 121. Perform density tests for acceptance of lightweight concrete after final corrections for entrained air and slump have been made. When a density test is made and the results of the test exceed the specified maximum, perform a check test immediately from the same load of concrete. If the average of the 2 test results exceeds the specified maximum density, the load is rejected.

The quantity for Sand Lightweight Concrete is the volume of specified concrete within the neat lines of the structure as shown on the Plans or as revised by the RCE and is measured by the cubic yard (CY) of concrete, complete, and accepted. Deductions are made for the volume of embedded items, except for reinforcing steel; however, no deduction is made for edge chamfers of $\frac{3}{4}$ inch or smaller.

(62) SECTION 701: NON-CONFORMING CONCRETE:

For purposes of applying the reduced payment and below strength provisions of Subsection 701.2.12.4 of the Standard Specifications, a unit price of 850 dollars per cubic yard will be used for normal weight concrete and a unit price of 880 dollars per cubic yard will be used for sand lightweight concrete.

(63) SECTION 701: DRILLED SHAFT CONCRETE CLASS 4000DS - MASS CONCRETE MIX DESIGN

The requirements of this Special Provision apply only to the concrete mix design for drilled shafts with a diameter of 6 feet or larger. This Special Provision modifies the requirements of Standard Specification 701.4.9 Fly Ash and Water-Granulated Blast-Furnace Slag as it relates to the mix design for Class 4000DS Structural Concrete.

Subsection 701.4.9 Fly Ash and Water-Granulated Blast-Furnace Slag

Replace Subsections C and D with the following:

C. When fly ash is used to replace the Portland cement, replace at a ratio of not less than 1.2:1 by weight, and do not replace more than 40% of the cement originally called for in the mixture.

D. When water-granulated blast-furnace slag is used to replace Portland cement, replace at a ratio of 1:1 by weight, and do not replace more than 60% of the cement originally called for in the mixture.

Add the following Subsections:

J. When a combination of multiple different supplementary cementitious materials is used, do not replace more than 75% of the total cement originally called for in the mixture.

K. Do not use Class C fly ash when the percentage replacement exceeds 20%.

L. Do not use High-early-strength (ASTM C150 Type III or ASTM C1157 HE) cement, metakaolin, silica fume, calcium chloride and accelerating type admixtures unless an adiabatic temperature study is completed and accepted by the BCE showing temperature rise significantly less than that of plain unmodified cement.

(64) SECTION 702: MASS CONCRETE PLACEMENT

This Special Provision modifies the requirements of Standard Specification 702.4.2.5 for mass concrete placement

A. SUBSECTION 702.4.2.5 MASS CONCRETE PLACEMENT

Replace first Paragraph with following:

Use procedures for mass concrete placement for a structural concrete pour that has dimensions of 5 feet or greater in 3 different directions. In the case of a circular cross-section, a mass

concrete placement is defined as a structural concrete pour that has a diameter of 6 feet or greater and a length of 5 feet or greater.

(65) SECTION 704: PRESTRESSED CORED SLABS:

Subsection 704.4.6 of the Standard Specifications is amended as follows:

- A. Delete Paragraph 2 of Subsection 704.4.6.2 and replace it with the following:
“Provide holes and recesses at locations indicated in the Shop Plans for insertion of the 1¼ -inch diameter transverse tie rods.”
- B. Delete the last sentence of Subsection 704.4.6.4 and replace it with the following:
“Make certain of the correct alignment of the holes for the transverse tie rods.”
- C. Delete Subsection 704.4.6.5 and replace it with the following:

704.4.6.5 Transverse Tie Rods

In each span, place 1¼-inch diameter transverse tie rods and tighten to a snug fit. After the 1¼-inch diameter transverse tie rods have been tightened in a span and before any equipment, material or barrier parapet is placed on the span, fill the shear keys, dowel holes, and tie rod recesses with the non-shrink grout as indicated on the Plans and allow curing for a minimum of 3 days. To prevent leakage of grout, place foam backer rod or other material acceptable to the RCE along the bottom of the joint between adjacent slab units. Ensure that the grout reaches a compressive strength of 5000 psi in 24 hours. Properly remove any foreign substance/materials including grease from the exposed portions of transverse tie rods before grouting the recesses.

With the approval of the RCE, material and equipment may be placed on the cored slab spans after the transverse tie rods have been tightened, the grout in shear keys has cured for 3 days minimum, and the grout has reached a compressive strength of 5000 psi.”

(66) SECTION 711: PILE AND DRIVING EQUIPMENT DATA FORM:

Pile and Driving Equipment Data Form is included in Attachment B.

(67) SECTION 711: GALVANIZED STEEL H PILING AND SWAY BRACES:

March 16, 1999

A. GENERAL

This Supplemental Specification covers the cleaning, hot dip shop galvanizing, field cleaning and field repair of galvanizing for new Steel H Bearing Piling and Steel Sway Bracing where required and detailed in the plans.

B. SURFACE PREPARATION

The coating applicator shall pre-clean the material to be galvanized in accordance with accepted methods to produce an acceptable surface for hot dip galvanizing.

C. SHOP GALVANIZING

Hot dip galvanizing of iron and structural steel shapes shall be produced utilizing lead free technology. Steel H Bearing Piling and Steel Sway Braces shall be hot dip galvanized in accordance with the latest ASTM A 123 Specification to provide a uniform minimum coating thickness of 3.5 mils (89 µm). Shop repair of coatings not meeting the above minimum thickness requirements will not be allowed.

Galvanizing practices and procedures shall protect against possible embrittlement of the steel as described in ASTM A143.

EXHIBIT 5 – SPECIAL PROVISIONS AND CONTRACT REQUIREMENTS

Inspection and testing of hot dip galvanized coatings shall be done under the requirements of ASTM A 123.

The coating applicator shall have available for inspection a quality assurance manual and shall submit an original and two copies of the coating applicator's notarized Certificate of Compliance that the hot dip galvanized coating meets or exceeds the specified requirements of ASTM A 123 as modified by this Specification.

Galvanized members shall be stored, protected, handled and loaded in accordance with industry standards to protect the coating.

D. SHOP INSPECTION

Inspection of galvanizing practices and procedures will be performed by the Department's Research and Materials Laboratory. As soon as the project has been awarded, the Contractor shall notify the Research and Materials Laboratory at (803) 737-6698, P. O. Box 191, Columbia, South Carolina 29202. The Contractor shall provide the name and address of the coating applicator so that the inspection arrangements can be made.

E. FIELD REPAIR OF GALVANIZING

Field repair of galvanized coatings may be used to repair damaged areas, weld areas at pile splices, weld areas at sway braces to piles or other areas of coating damage. All field repairs shall be made in accordance with ASTM A 780. The Engineer shall be the sole judge of damaged areas that require field repair of the galvanized coating.

When galvanized members are to be field welded the Contractor shall clean the area at the weld location for a distance sufficient to provide an area free of coating for the weld metal to be deposited. The Contractor's cleaning method shall be pre-approved by the Engineer and cleaned areas shall be inspected and approved prior to field welding.

F. METHOD OF MEASUREMENT

The galvanizing of Steel H Bearing Piling and Sway Braces will not be measured for payment. All cost for galvanizing shall be included in the price bid for the item galvanized.

G. BASIS OF PAYMENT

All costs for labor, materials, equipment, tools and other incidentals required to galvanize the Steel H Bearing Piling and Sway Braces shall be included in the price bid for those items. No separate payment will be made for galvanizing.

(68) SECTION 711: DRIVEN PILES

For piles in the water, utilize "Slow Starts" for impact driving. A "Slow Start" is defined as an initial set of three strikes from the impact hammer, followed by a 1-minute waiting period, then two subsequent three-strike sets which are separated by a 1-minute waiting period.

(69) SECTION 712: DRILLED SHAFT FORMS:

Drilled Shaft Forms are included on the Construction Extranet.

(70) SECTION 712: CONCRETE PLACEMENT AND TEMPERATURE CONTROL FOR LARGE DIAMETER DRILLED SHAFTS

A. DESCRIPTION

The requirements of this Special Provision only apply to drilled shafts that have a diameter of 6 feet or greater and a length of 5 feet or greater and shall consist of furnishing all necessary submittals and materials for providing drilled shaft concrete placement and temperature control in accordance with the details shown on the plans and the requirements of the Special Provisions. The requirements of this Special Provision are in addition to the drilled shaft and concrete requirements of the Standard Specifications. This Special Provision supersedes the

EXHIBIT 5 – SPECIAL PROVISIONS AND CONTRACT REQUIREMENTS

Standard Specifications in one area in that the maximum allowable concrete temperature at discharge into the shaft is 80°F.

B. PLACEMENT

1. Concrete Mix Temperature: For all drilled shaft concrete pours, do not allow the mix temperature to exceed 80°F measured at discharge into the shaft. Throughout the length of shaft, maintain a temperature differential of 35°F or less between the center of shaft and just inside the nearest face of shaft.
2. Concrete Curing Temperature: The maximum concrete temperature during curing shall not exceed 160 °F within the drilled shaft.
3. Drilled Shaft Concrete Placement Plan: At least 30 days before placing drilled shaft concrete, submit to the BCE for review and acceptance a *Drilled Shaft Concrete Placement Plan* containing, but not limited to, the following:
 - a. Analysis of the anticipated thermal developments within the drilled shafts using the proposed materials and casting methods,
 - b. *Temperature Control Plan* outlining specific measures to control the temperature differential within the limits noted above,
 - c. Details of how the central CSL access tube will be held in place during cage installation and concrete placement, and
 - d. Details of how the concrete will be placed to accommodate the central CSL tube and the associated support elements.
4. Temperature Monitoring Devices: During the heat of hydration, Department personnel or a Department designated representative will monitor the drilled shaft temperature differential between the interior and exterior CSL access tubes using Thermal Integrity Profiling equipment. Differential temperature monitoring will be performed for the entire length of the shaft. Monitoring will continue at least until the peak heat of hydration has occurred.
5. Temperature Monitoring Results: If the monitoring indicates that the proposed measures are not controlling the concrete curing temperature with the maximum concrete temperature specified, make the necessary revisions to the *Temperature Control Plan* and submit the revised plan for review.

C. CONTRACTOR'S RESPONSIBILITY

The Contractor assumes all risks connected with placing a large diameter drilled shaft pour of concrete. BCE review of the Contractor's *Drilled Shaft Concrete Placement Plan* will in no way relieve the Contractor of the responsibility for obtaining satisfactory results. Should any drilled shaft concrete placed under this Special Provision prove unsatisfactory, make the necessary repairs or remove and replace the material at no expense to the Department.

D. BASIS OF PAYMENT

Include all costs associated with concrete placement and temperature controls for large diameter drilled shafts in the unit cost bid for the drilled shaft concrete.

(71) SECTION 714: SMOOTH WALL PIPE:

A. REFERENCE

SCDOT Supplemental Technical Specification SC-M-714

B. DESCRIPTION

When bid items for smooth wall pipe are listed in the EBS file and/or proposal, the SCDOT will allow the use of reinforced concrete pipe, spiral ribbed aluminum pipe or high density polyethylene pipe in accordance with the specifications found in SC-M-714 (latest edition), the Standard Drawings, and this Special Provision. The plans may indicate reinforced concrete pipe only and are hereby superseded by this Special Provision.

C. MATERIALS

Smooth wall pipe is either Reinforced Concrete Pipe (RCP: 714-205-XX), Spiral Ribbed Aluminum Pipe (SRAP: 714-605-XX), or High Density Polyethylene pipe (HDPE: 714-705-XX) as described in SCDOT Supplemental Technical Specification SC-M-714 and in the SCDOT Standard Drawings. Use smooth wall pipe culvert from manufacturers listed on Qualified Product Lists 30, 68, or 69. No value engineering application is required in order to use alternate pipe.

For the following counties: Berkeley, Beaufort, Charleston, Colleton, Dorchester, Georgetown, Horry, and Jasper, provide pipe joints meeting AASHTO M 315 for RCP or passing the 13 psi pressure test as indicated on the QPL for SRAP or HDPE. Take care to properly lubricate and equalize pipe gaskets as indicated in the **SCDOT Standard Drawings** and **SC-M-714** to prevent gaskets from “rolling” during installation. For all other counties, provide pipe joints meeting AASHTO M 198, M 315, or passing the minimum 10 psi pressure test unless specific pipe joints are indicated in the plans or special provisions.

No other pipe type will be accepted as an alternate.

D. CONSTRUCTION REQUIREMENTS

Use only pipe that conforms to the minimum and maximum fill height limitations indicated on the appropriate standard drawing. Unless indicated otherwise in the plans, determine pipe fill height based on the following formula:

Fill Height = Elevation (top of curb or max grade above pipe) – Elevation (pipe crown)

For all locations where new pipe is being attached to an existing system, use one of the following options:

1. Any existing pipe may be extended using any acceptable alternate pipe type by using a drainage structure at the interface between the different pipe types. The drainage structure* may consist of standard junction boxes, manholes, catch basins, drop inlets, or circular drainage structures detailed on **SCDOT Standard Drawings**. For larger diameter pipe, custom drainage structures may be required. Field cut existing pipe to remove damaged joint (if applicable) and install new drainage structure at the field cut interface. Always fully clean existing pipe and pipe joints before installing joint sealant or gaskets and attaching new pipe.
2. For locations where existing pipe properties cannot be directly matched, use a custom designed interface* (concrete collar, proprietary mastic wrap, custom coupling band, etc.) appropriate to interface the existing pipe to the new pipe of the same type. Submit interface drawings and design for review by the Engineer of Record and the Design Standards Engineer. Always fully clean existing pipe and pipe joints before installing joint sealant or gaskets and attaching new pipe. Replace existing pipe that has joint damage before connecting new pipe to the system.
3. Any existing pipe may be extended using new pipe with the same joint profile and wall properties of the existing pipe. Always fully clean existing pipe and pipe joints before installing joint sealant or gaskets and attaching new pipe. Verify* the following parameters before ordering new pipe:
 - a. For RCP to RCP, confirm wall thickness, joint profile shape, and compatibility with existing manufacturer’s pipe. Replace existing pipe that has joint damage before connecting new pipe to the system.
 - b. For SRAP to SRAP, replace existing pipe that has joint damage before connecting new pipe to the system.
 - c. For HDPE to HDPE, confirm the manufacturer of the existing pipe and the joint compatibility with the new pipe. Provide a new gasket when connecting to existing spigot

EXHIBIT 5 – SPECIAL PROVISIONS AND CONTRACT REQUIREMENTS

end of HDPE pipe. Replace existing pipe that has joint damage before connecting new pipe to the system.

- d. For CAAP to CAAP, confirm the type and size of end corrugations of the pipe. When existing pipe has full helical corrugations, provide new connecting pipe with one end fully helical and fully helical coupling band. When end corrugation size does not match the corrugation size shown on SCDOT Standard Drawings, provide a drainage structure (described above) at the interface. Replace existing pipe that has joint damage before connecting new pipe to the system. Do not install CAAP as smooth wall pipe; however, use these requirements when plans specify installing new CAAP.

The **RCE** will verify that connections between existing pipe and new installed pipe have been handled with one of the options listed above. Repair or replace all existing to new joint interfaces that do not meet the requirements above at no additional cost to **SCDOT**.

In all installations, provide the RCE with a complete pipe table indicating the following: Plan Pay Item, Plan Pipe Description, Plan Quantity, Installed Pipe (diameter, type, class/gage), Installed Quantity, and description of interface used to join new pipe to existing pipe for each occurrence.

In cases where 2 or more different pipe types are installed, provide a copy of the proposed installation layout on the drainage/plan sheets to the RCE indicating which pipe is installed at each location.

E. MEASUREMENT

Measure smooth wall pipe in accordance with methods specified in SC-M-714 for the pipe material installed.

*No measurement will be made for drainage structure, designed interface, or field verification performed at each interface between existing pipe and new pipe unless drainage structure/interface is specified in the plans.

F. PAYMENT

Payment will be made for smooth wall pipe regardless of the type of material installed. Payment for smooth wall pipe is as specified in SC-M-714 for the pipe material installed.

*Include all costs for work related to connecting new pipe to existing pipe in the unit bid price of the new pipe. This connection work includes: drainage structure at the interface, custom designed interface, field verification of existing pipe and compatibility with new pipe, new gaskets, new joint sealant, new coupling bands, removal, and disposal of damaged sections of existing pipe.

ITEM NO.	DESCRIPTION	UNIT
7143XXX	X" SMOOTH WALL PIPE	LF
7143XXX	X"x X" SMOOTH WALL PIPE CUL.TEE	EA
714XXX	X" x X" SMOOTH WALL PIPE CUL.WYE	EA
7144XXX	X" SMOOTH WALL PIPE X DEG BEND	EA
7144XXX	SMOOTH WALL PIPE INCR.- X" TO X"	EA

(72) SECTION 714: PIPE END TREATMENTS (2/5/2010):

A. REFERENCE

SCDOT Supplemental Technical Specification SC-M-714

B. DESCRIPTION

For exposed pipe culvert ends, provide an end treatment in accordance with this special provision.

EXHIBIT 5 – SPECIAL PROVISIONS AND CONTRACT REQUIREMENTS

C. MATERIALS

Rigid pipe culvert is Reinforced Concrete Pipe (RCP: 714-205-00). Flexible pipe culvert is either Spiral Ribbed Aluminum Pipe (SRAP: 714-610-00), High Density Polyethylene pipe (HDPE: 714-705-00), or Corrugated Aluminum Alloy Pipe (CAAP: 714-605-00).

Use minimum Class B riprap for pipe up to 84" diameter. Use minimum Class C riprap for pipe 84" diameter or larger.

Use minimum Class 4000 concrete (4000P for precast).

Use ASTM A-706 grade 60, low-alloy steel deformed rebar.

Use minimum AASHTO M-196 Alclad 3004-H32 alloy aluminum.

Use Type M Mortar Grout unless specified otherwise.

D. CONSTRUCTION REQUIREMENTS

Use one of the following end treatments as specified in the plans or special provisions:



For all exposed crossline pipe ends, when an end treatment is not specified in the plans, use **Pipe Riprap Protection** (804-3xx-xx). For flexible pipe larger than 24" diameter, install pipe straight headwall, pipe end structure, flared end section, or wingwall section in addition to riprap. For all exposed driveway pipe ends where no end treatment is specified in the plans, use **Pipe Riprap Protection** (804-3xx-xx) unless directed otherwise by the engineer.



Use **Beveling of Pipe End** (719-610-00) when specified in the plans or special provisions. Beveled ends may only be used on flexible pipe up to 24" diameter and on rigid pipe up to 60" diameter. When beveling of pipe ends is specified on flexible pipe larger than 24" diameter, install pipe straight headwall, pipe end structure, flared end section, or wingwall section. Use factory fabricated beveled ends for all pipe types unless approved by the Engineer.

EXHIBIT 5 – SPECIAL PROVISIONS AND CONTRACT REQUIREMENTS



Use **Pipe Straight Headwall** (719-605-00) when specified in the plans or special provisions. Use straight headwall only in locations where pipe exposed end does not face the direction of traffic.



Use **Pipe End Structure** (719-615-00) when specified in the plans or special provisions. Use pipe end structure in locations where pipe exposed end faces the direction of traffic. Pipe end structures may be used in other locations if approved by the RCE.



Use **Pipe Flared End Section** when specified in the plans or special provisions.



Use **Pipe Wingwall Section** when specified in the plans or special provisions.

Completely seal interface between pipe and end treatment with grout. If bricks or shims are used to place pipe, take care to remove all air pockets and voids when grouting.

For systems not designed in the SCDOT Standard Drawings, provide shop drawings, installation procedure and design calculations for review by RCE. Design must include provision to control erosion around the structure and prevent the separation of the end treatment from the pipe system. Design must provide for a proper seal at all construction joints including the interface between the pipe and the structure. Design must be self-supporting and not induce any additional loads on the pipe. Submit designs for consideration as new standard drawings to the Design Standards Engineer at the address listed in the SCDOT Standard Drawings book.

E. MEASUREMENT

Measure pipe in accordance with SC-M-714

Measure end treatments in accordance with Standard Specifications, Standard Drawings, or Special Provisions

F. PAYMENT

Beveling of pipe ends will be in addition to the standard pipe pay item. Payment for the item Beveling of Pipe Ends includes all labor required to factory (or field, if approved) fabricate a bevel on one end of pipe.

Pipe culvert and end treatments, measured as provided in **SC-M-714 Subsection x.4**, are paid for at the contract unit price for the respective items, which price and payment is compensation for furnishing all material, labor, equipment, tools including hauling and placing all pipe sections and materials, excavation of the entire standard trench, bedding, and pipe backfill as described in the measurement section (both structural and embankment backfill in this region), removal of existing pipe to be replaced, constructing pipe joints, removal of old end treatments, cleaning out pipe, disposal of surplus materials, all visual inspection, and all incidentals necessary to complete the work.

Add the following paragraph to SC-M-714 subsections x.5:

Payment for riprap and geotextile for erosion control under riprap as measured in subsection x.4 includes all direct and indirect costs and expenses necessary to complete the work.

(73) SECTION 714: TRENCHLESS PIPE INSTALLATION:

A. DESCRIPTION

This work consists of jacking a reinforced concrete pipe to serve as a carrier pipe in the locations designated in the plans or as specified by the Engineer. This procedure enables the installation of reinforced concrete pipes underground without the use of open-cut excavation and/or ground stabilization techniques. Ensure that this process minimizes surface disruption and allows the Engineer to consider the routing of pipe without the constraints imposed by a trench.

B. MATERIALS

1. Carrier Pipe

Ensure the carrier pipe is a jacked in place reinforced concrete pipe conforming to Section 714 of the South Carolina Department of Transportation Standard Specifications. The class or strength of the reinforced concrete pipe shall be determined by appropriate pipe-soil analysis following the prescribed methods outlined in ACPA – Design Data 13 and ACPA Concrete Design Handbook. The pipe manufacturer may submit an alternate design following the direct design procedure of ASCE 27-00. Precast reinforced box culverts used in trenchless applications shall conform to general provisions of Sections 722 of the South Carolina Department of Transportation Standard Specifications. The box culvert design shall follow the prescribed method in ASCE 28-00. Ensure the carrier pipe meets the

minimum requirements of a Class V reinforced concrete pipe and is of the size specified in the plans.

If the carrier pipe specified in the contract documents has an inside diameter greater than 30 inches, use a Class V Special reinforced concrete pipe. Submit the design of the Class V Special pipe to the Resident Engineer for approval.

Ensure the pipe surface is even and the ends are square and smooth so that jacking loads are evenly distributed around the entire pipe joint, such that point loads are minimized when the pipe is jacked into place. Protect the driving ends of the pipe and intermediate joints against damage. Indicate the detailed method proposed to cushion and distribute the jacking forces on the working drawing submittals to the Engineer for approval. Any pipe showing signs of failure may be required to be jacked through to the reception shaft and removed. Other methods of repairing the damaged conduit may be used, as recommended by the manufacturer and subject to approval by the Engineer. Do not exceed the pipe manufacture's design jacking load during the installation process.

If the carrier pipe specified in the contract documents has an inside diameter of 30 inches or less, the Contractor may use an aluminum or high-density polyethylene pipe as the carrier pipe. The design and installation of the aluminum and high-density polyethylene pipe shall be submitted to the Engineer for approval before use.

2. Casing Pipe

If the carrier pipe specified in the contract documents has an inside diameter of 30 inches or less, the Contractor may jack a steel pipe into place first to serve as the casing pipe. Ensure that the casing pipe meets all of the requirements described above and has a ½ inch minimum wall thickness as determined necessary relative to the insitu soils. Do not use the steel casing pipe as the carrier pipe.

If the carrier pipe has an inside diameter greater than 30 inches, the Contractor may jack a steel pipe into place first to serve as the casing pipe but with no additional compensation.

3. Grout

Using an approved flowable fill grout mixture, fill the annular space created around the conduit by the over cut in excess of 3/4 inch by the use of a tunnel boring machine (TBM) or by any casing left in place. Ensure the mixture consist of 1:3 (Portland Cement Type III: sand) grout with sufficient water added to produce a flowable mixture that can be delivered at a sufficient pressure to prevent settlement. Ensure the pressure-injected grout fills the voids outside the limits of the excavation created by caving or collapse of earth cover over the excavation. If a casing pipe is required, also fill the annular space created between the casing and the carrier pipe with the approved grout mixture. Furnish and operate suitable equipment for any required grouting operations depending on the condition of the application. Ensure grouting operation does not damage adjacent utilities or other properties. Inject the grout at a pressure that does not distort or imperil any portion of the work or existing installations or structures.

4. Lubrication Material

An approved lubricant may be used during the pipe jacking installation to lower the friction developed on the surface of the pipe. Continuously monitor and control the pressure of delivery of the lubrication material to prevent pipe buckling or ground heave. Ensure the material is used in accordance with the manufacturers' specifications and is a material intended for use in this application. Submit the lubricating systems and materials to the Engineer for review and approval before use.

5. Automated Spoil Transportation System

Ensure the excavation rate matches the rate of spoil removal thereby maintaining settlement or heave within tolerances specified in the contract documents. Make sure the system is capable of any adjustments required to maintain face stability for the particular soil condition to be encountered on a project. Ensure the system monitors and continuously balances the ground water pressure. If the soil has excessive ground water, the Contractor must provide an earth pressure balance system for review by the Engineer before use.

C. CONSTRUCTION REQUIREMENTS

1. Submittals

Submit Shop Drawings, Material Certification, design certifications, and other information as specified for all materials in this Section in accordance with the requirement for Submittals in these specifications. Ensure Shop Drawings also include complete erection, installation, and adjustment instructions and recommendations.

Allow 20 working days for the review of the submittal by the Engineer. Obtain approval of the submittal prior to ordering pipe materials and the start of any excavation or jacking operations. Submit the following items for review and approval by the Engineer:

- a. Manufacturers' data sheets and specifications describing in detail the jacking system to be used and similar projects on which this system has been successfully used.
- b. Maximum anticipated jacking loads and supporting calculations signed and sealed by an engineer registered in the State of South Carolina.
- c. Calculations for the design of the casing pipe signed and sealed by an engineer registered in the State of South Carolina.
- d. Certification by the manufacturer that the pipe materials conform to the requirements of the Specifications and Plans.
- e. Casing dimensions, if necessary, to accommodate the carrier pipe size indicated on the plans.
- f. Shaft dimensions, locations, surface construction, profile, depth, and method of excavation.
- g. Description of method(s) to control and dispose of ground water, spoil, temporary shoring, and other materials encountered in the maintenance and construction of pits and shafts.
- h. Layout and design of all shoring, bracing, and thrust block systems, including calculations, certified by an engineer registered in the State of South Carolina.
- i. Description of grouting methods, manufacture's data, and specifications for grouting equipment.
- j. A description of the grade and alignment control system used for the tunneling equipment.
- k. Description of lubrication system and materials to be employed during installation of the reinforced concrete pipe.
- l. Layout plans and descriptions of the construction sequence.
- m. A detailed plan for monitoring ground surface movement (settlement or heave) due to the tunneling operation. Ensure the plan addresses the method and frequency of survey measurements. At a minimum, ensure the plan measures the ground movement of all structures, roadways, parking lots, and any other areas of concern within 25 feet on both sides of all tunneling pipelines at a maximum spacing of 10 feet along the pipeline route, or as required by the Engineer.

- n. Contingency plans for approval for the following potential conditions: damage to pipeline structural integrity and repair; loss and return to line and grade; and loss of ground.
- o. Procedures to meet all applicable OSHA requirements. Submit these procedures for record purpose only, not for approval by the Engineer. At a minimum, provide the following:
 - 1) Protection against soil instability and ground water inflow.
 - 2) Safety for shaft access and exit that includes ladders, stairs, walkways, and hoists.
 - 3) Protection against mechanical and hydraulic equipment operations, and for lifting and hoisting equipment and material.
 - 4) Ventilation and lighting.
 - 5) Monitoring for hazardous gases.
 - 6) Protection against flooding and means for emergency evacuation.
 - 7) Protection of shaft, including traffic barriers, accidental or unauthorized entry, and falling objects.
 - 8) Emergency protection equipment.
 - 9) Name of person or personnel onsite who is responsible for work and safety supervision, and their responsibilities.

Ensure all submittals requiring structural design are signed and sealed by a Professional Engineer registered to practice engineering in the State of South Carolina.

2. Pipe Jacking Excavation Methods

The Contractor is allowed to use any one of the following excavation methods for the pipe jacking operation:

- a. Full Face Tunnel Boring Machine (TBM)
- b. Open Hand Shield
- c. Earth Pressure Balance Machine (EPBM)
- d. Backacter Shield
- e. Cutter Boom Shield
- f. Air Pressure Shield
- g. Microtunneling

Note: The cutter boom shield method is only applicable in dry ground conditions. The air pressure shield method is only applicable in wet ground conditions. The Contractor is not allowed to use a slurry-boring machine for excavation.

The Resident Engineer must approve the excavation method chosen by the Contractor before excavation begins.

Ensure the excavation method used for installing the jacked pipe is of such size and capacity that it will allow tunneling to proceed in a safe and expeditious manner. Ensure the installation of the pipe and the tunnel excavation is done as rapidly as possible and simultaneously to avoid voids, cave-ins, or settlement and for the safety of the traffic above.

3. Carrier Pipe Installation

Jack a reinforced concrete pipe, serving as a carrier pipe, with jacks of sufficient capacity to shove the pipe through the resisting material into position true to required line and grade. Check the vertical and horizontal alignment of the carrier pipe by survey instrument at least once during each four feet of advance, or as directed by the Engineer.

EXHIBIT 5 – SPECIAL PROVISIONS AND CONTRACT REQUIREMENTS

The Contractor is responsible for the design, adequacy, and methodology of the pipe jacking installation. The methods and details shown on the Drawings and specified herein are intended to indicate the minimum acceptable standard of quality required for pipe installation. Submit alternative methods to the Engineer for review and approval prior to beginning work.

Ensure all excavations and pits are well sheeted and braced as necessary for safe and adequate access for workmen, inspections, and materials and are of a size suitable to equipment and material handling requirements.

Ensure all of the Contractor's plans, specifications, and design computations for pit shoring are sealed and signed by a Professional Engineer registered in the State of South Carolina. Ensure all pits required for the installation of the reinforced concrete pipe and located within SCDOT right-of-way are completely isolated from the roadway traffic with precast concrete barriers installed in accordance with the Standard Drawings.

4. Casing Pipe Installation (If required)

Jack a steel pipe in place first to serve as the casing pipe. Ensure that the casing pipe follows the carrier pipe installation requirements stated in Section 3.3.

a. Cradle Installation

Following the completion of the casing pipe installation and grouting operations, furnish pipe cradles, spiders, or guides within the casing for the purposes of guiding and supporting the installation of the carrier pipe. Indicate the methods of support and guidance in the submittal to the Engineer. Ensure the method proposed provides adequate support of the pipe throughout the installation and ensures that the carrier pipe is installed at the line and grade indicated in the Plans.

b. Carrier Pipe Installation

Install the carrier pipe with adequately designed and spaced pipe alignment guides or "spiders", secured, and bulkheaded as shown on the working drawings. The proposed procedure to install the carrier pipe is to "bell-up" the pipe outside the casing and push the carrier pipe through the casing.

5. Surface Settlement Monitoring

Before beginning the jacking operations, establish a settlement monitoring system that has been approved by the Engineer. If any settlement or construction damage occurs to Authority traffic lanes, pavements, structures, facilities, appurtenances and/or lands, restoration to original conditions or better shall be undertaken and completed as directed by, and to the satisfaction of, the Engineer at the Contractor's expense.

Delays between jacking operations may result in soil settling around the jacked pipe, thus making it difficult and sometimes impossible to resume movement. Should conditions arise making it impossible to further jack the pipes without damage, construct the balance of the pipe installation with methods approved by the Engineer.

6. Drainage Facilities

Perform all dewatering as required for the completion of the work. Submit all proposed procedures for dewatering to the Engineer for review prior to any earthwork operations. Dispose of all water removed by dewatering operations in accordance with applicable South Carolina Department of Health and Environmental Control regulations.

Ensure the dewatering system is of sufficient size and capacity as required to control groundwater or seepage to permit proper excavation and tunneling operations. Drawdown

EXHIBIT 5 – SPECIAL PROVISIONS AND CONTRACT REQUIREMENTS

groundwater to at least the bottom of excavations at all times in order to maintain a dry and undisturbed condition.

Ensure control, by acceptable means, of all water regardless of source. Ensure the entire periphery of the excavation areas are ditched and diked to prevent water from entering the excavation where applicable. The Contractor is fully responsible for disposal of the water and providing all necessary means at no additional expense to the Owner. The Contractor is solely responsible for proper design, installation, operation, maintenance, and failure of any component of the system.

The Contractor is responsible for and will repair without cost to the Owner, any damage to work in place and the excavation, including damage to the bottom due to heave and including removal of material and pumping out of the excavated area. The Contractor is also responsible for damages to any other area or structure caused by his failure to maintain and operate the dewatering system proposed and installed.

Take all the steps necessary to become familiarized with the surface and subsurface site conditions. Obtain the data that is required to analyze the water and soil environment at the site to assure that the materials used for the dewatering systems will not erode, deteriorate, or clog to the extent that the dewatering systems will not perform properly during the period of dewatering. Copies of the borings logs in the area of installation and laboratory test results are available for the Contractor's review. This data is furnished for information only, and it is expressly understood that the Owner and Engineer will not be held responsible for any interpretations or conclusions drawn there from by the Contractor.

If, in the course of construction, it may be necessary to block a ditch, pipe or other drainage facility, install temporary pipes, ditches or other drainage facilities to maintain adequate drainage, as approved by the Engineer. Upon completion of the work, remove the temporary facilities and restore the permanent facilities.

D. METHOD OF MEASUREMENT

Make measurements on the basis of linear feet of carrier pipe supplied and installed, complete and accepted. Do not make any measurements for damaged or non-conforming sections that were removed and replaced.

E. BASIS OF PAYMENT

The bid schedule provides a unit price for supply and installation of pipe. This price includes full compensation for furnishing and installing the carrier pipe, casing pipe (if required), pipe alignment guides (if required), and for providing all materials, equipment, and labor for excavation, dewatering, jacking, tunneling, grouting, and shoring as required for a complete installation.

Consider all other work required to complete the reinforced concrete pipe installation as incidental to this bid item and no specific payment will be made.

No payment will be made until the carrier pipe is installed and all annular space grouted as specified in Section 2.3.

For completing the work specified under this section, and as shown on the Drawings, the Engineer will pay the Contractor the Unit Price Bid for the Pay Item stipulated below:

Pay Item	Description	Pay Unit
71418XX	X" RC PIPE (TRENCHLESS)	LF

(74) SECTION 719: CAST IN PLACE CONCRETE PIPE COLLAR:

A. DESCRIPTION

A cast in place concrete pipe collar is used to provide a permanent connection between two pipe culverts of the same diameter but different joint profiles. Pipe collars can be used between two pipe of the same material or different material. Use only pipe that conforms to SC-M-714, Permanent Pipe Culverts.

B. MATERIAL

Use minimum class 4000 concrete.

Use reinforcement steel conforming to ASTM A706 Grade 60.

See SCDOT Standard Drawings or Project Plans for other material requirements and design details.

C. CONSTRUCTION REQUIREMENTS - GENERAL

Follow SCDOT Standard Drawings 719-705-xx for minimum dimensions and details. Use geotextile wrap on joint to minimize concrete intrusion into the joint during the forming and curing process.

D. MEASUREMENT

Measure concrete pipe collars by each location where pipe diameter of different joint profiles are to be connected. Include in measurement all materials and work to complete the pipe collar as shown in the Standard Drawings or plans.

E. PAYMENT

Payment will be made for each location.

ITEM NO.	DESCRIPTION	UNIT
7197051	CONCRETE COLLAR FOR UP TO 12" PIPE	EA
7197052	CONCRETE COLLAR FOR UP TO 24" PIPE	EA
7197053	CONCRETE COLLAR FOR UP TO 36" PIPE	EA
7197054	CONCRETE COLLAR FOR UP TO 48" PIPE	EA
7197055	CONCRETE COLLAR FOR UP TO 60" PIPE	EA
7197056	CONCRETE COLLAR FOR UP TO 72" PIPE	EA

(75) SECTION 727: CROSSHOLE SONIC LOGGING OF DRILLED SHAFT FOUNDATIONS:

Crosshole Sonic Logging (CSL) Testing is required for all drilled shafts. SCDOT shall be responsible for all CSL Testing.

(76) SECTION 727: CROSSHOLE SONIC LOGGING AND THERMAL INTEGRITY PROFILING OF DRILLED SHAFT FOUNDATIONS

Amend Subsections 727.1, 727.3, 727.4.1, and 727.4.2 of the Standard Specifications to include the following additional requirements:

727.1 Description. This section includes specifications for Thermal Integrity Profiling (TIP), which consists of measuring the temperature of the concrete resulting from heat of hydration to assess the quality of cast-in-place concrete. TIP testing will be performed by Department personnel or a Department designated representative. TIP testing may be performed on all shafts or a portion thereof as determined by the BCE. CSL testing will be performed on all shafts and acceptance of the shafts will be as indicated in **Subsection 727.4.3**. The Department reserves the right to use the results of the TIP testing to aid in the evaluation of a shaft.

EXHIBIT 5 – SPECIAL PROVISIONS AND CONTRACT REQUIREMENTS

727.3 Equipment. Equipment used for TIP testing will be furnished by the Department or a Department designated firm. TIP testing will be performed using the Thermal Wire Cable system and the CSL access tubes.

727.4.1 Preparation. In addition to the access tubes that are required around the inside of the circular reinforcement cage, install an access tube in the center of the shaft. Provide an access platform for the Department’s personnel to safely and adequately perform TIP testing.

727.4.2 Thermal Integrity Profiling. Department personnel or a Department designated representative will perform TIP testing before CSL testing. Thermal wires will be connected to a Thermal Access Port (data logger) within four hours of shaft concrete placement. Data will be collected by the data logger every 30 minutes for the duration of at least 48 hours. The Department reserves the right to increase or decrease the data collection duration based on field conditions, anticipated thermal developments, and/or TIP results.

Furnish information regarding the shaft, tube lengths and depths, construction dates and other pertinent shaft installation observations or details to the RCE or the Department’s designated testing representative at the time of TIP testing.

Ensure CSL tubes remain filled with water until all TIP and CSL testing is completed. Before adding any additional water to CSL tubes during the TIP testing, discuss the issue with the RCE. If water is to be added during the TIP testing, heat the water to within 5 degrees of the existing water in the CSL tube prior to adding it.

Replace Subsections 727.5 and 727.6 of the Standard Specifications with the following:

727.5 Measurement. There is no separate measurement for providing and installing CSL tubes, filling and/or removing the potable water from the CSL tubes, heating water to place in the tubes, and grouting the CSL tubes for each drilled shaft and taking cores as directed by the RCE or BCE. The cost of this work is included in the contract unit bid price for the drilled shaft in which they are placed.

The quantity for the item Crosshole Sonic Logging Set-Up is measured by each (EA) platform setup, complete, and accepted. Each CSL platform includes TIP testing. No separate measurement will be made for TIP platforms.

727.6 Payment. Payment for the accepted quantity for Crosshole Sonic Logging Set-Up, measured in accordance with **Subsection 727.5**, is determined using the contract unit bid price for that pay item. Payment is full compensation for providing an access platform for the Department personnel to safely and adequately perform TIP and CSL testing and preparation of the CSL access tubes required to conduct TIP and CSL testing on a drilled shaft as specified or directed and includes all other materials, labor, equipment, tools, supplies, transportation, and incidentals necessary to fulfill the requirements of the pay item in accordance with the plans, the Specifications, and other terms of the Contract.

Payment includes all direct and indirect costs and expenses necessary to complete the work.

Pay items under this section include the following:

Item No.	Pay Item	Unit
7270010	Crosshole Sonic Logging Set-Up	EA

(77) SECTION 729: NAVIGATION LIGHTS FOR BRIDGE

729-1 Description

Furnish and install navigation lighting systems, including all wiring, conduit, wiring devices, transformers, enclosures, grounding system, controls, protective devices, lights, etc., in compliance

EXHIBIT 5 – SPECIAL PROVISIONS AND CONTRACT REQUIREMENTS

with Code of Federal Regulations (CFR), Title 33, Part 118, which is further clarified in U.S. Coast Guard (USCG) Publication "A Guide to Bridge Lighting". Navigation lights must operate from sunset to sunrise and during periods of low visibility.

729-2 Coordination of Electrical Work

Use experienced personnel in the type of work required by the Contract Documents to provide a complete and satisfactory fitting and fully operational installation. Perform all electrical work either by, or under the immediate supervision of an electrical journeyman. Schedule and arrange electrical work in a neat, well-organized manner without interference with the work scheduling of other trades.

729-3 Materials and Equipment

Meet the equipment and material requirements as shown in the Contract Documents. Furnish and install only materials and equipment of new stock meeting ANSI, NEC, NEMA, and UL requirements, and approved by the Engineer, except where the Contract Documents allow or specify the use of other than new equipment.

Furnish and install marine type products manufactured of corrosion resistant materials.

Furnish and install only fasteners manufactured from ASTM 316 stainless steel with yield strength 35,000 psi or higher.

Furnish and install ASTM 300 series stainless steel conduit straps or hangers held at not less than two points.

Furnish and install framework for supporting boxes, switches, and other externally mounted electrical devices fabricated from ASTM A709 Grade 36 hot-dip galvanized structural steel.

729-4 Navigation Lights and Aids

729-4.1 Navigation Lights: Equip all navigation lights with a LED array with a minimum of 50,000 hour life and bright enough to meet the visibility requirements of CFR Title 33, Part 118. Mount LED arrays on an internal shock and vibration isolator. Provide, in the circuit, a lightning surge suppressor capable of absorbing multiple strikes without replacement. Provide special power supply to provide current limited DC voltage to the LED array.

Furnish and install fixtures with unpainted housings of heavy duty cast aluminum or bronze construction with a 1-1/2 to 2 inch threaded conduit opening on the bottom. Use only marine type mounting boxes with minimum 3/4 inch conduit opening. Furnish and install fixtures with lenses that are standard marine molded, single-piece fresnel type, rigid, heat resistant glass or U.V. resistant polycarbonate and inside diameter of 7 to 8 inch. Furnish all stainless steel closure bolts, lens tie rods, and attachment hardware for a complete and accepted installation.

Furnish and install Pier/Fender Lights, Center Channel Lights and Channel Margin Lights with cast aluminum or bronze swivel assembly and mounting bracket, complete with stainless steel pivot, watertight "O" ring seal, bronze bearings, cable entrance fitting, and stainless steel service chain rated for a minimum 225 pounds load. Use a 1-1/2 or 2 inch galvanized pipe or stainless steel pipe as a hanger stem with automatic lock at service and operating positions. Furnish and install a 60% counterweight if stem exceeds 5 feet in length.

Ensure the Pier/Fender Light is equipped with a red 180 degree lens, the Center Channel Light is equipped with a green 360 degree lens and the Channel Margin Light is equipped with a red 180 degree lens.

729-4.2 Clearance Gauge Lights: If required by the USCG, furnish and install one-piece die-cast aluminum fixture housing fitted with watertight gasket, stainless steel hinges and fasteners, and

adjustable aiming capability, equipped with a 120 Vac, 50 watt, high-pressure sodium lamp. Use a heavy cast aluminum connection box body and cover with stainless steel swing bolts, watertight gasket and provisions for mounting to a platform with four stainless steel lag bolts or screws.

729-5 Disconnect Switches

Furnish and install switches that are HP rated and meet Federal and NEMA Specifications with NEMA Type 4X (stainless steel) enclosures, and with metal factory nameplates that are front cover mounted and contain a permanent record of switch type, catalog number, and HP rating. Provide switch with visible blades, reinforced fuse clips, and nonteasible, positive, quick make-quick break mechanisms. Provide switch assembly plus operating handle as an integral part of the enclosure base.

Use switches with defeat able door interlocks that prevent the door from opening when the operating handle is in the ON position, and whose handle position is easily recognizable and is padlockable in the OFF position. Use heavy-duty switches with line terminal shields.

729-5.1 Fusible Switch Assemblies: Furnish and install NEMA KS 1 type; load interrupter enclosed knife switch. Provide fuse Clips that are designed to accommodate Class R fuses.

729-5.2 Non-fusible Switch Assemblies: Furnish and install NEMA KS 1; HD type, load interrupter enclosed knife switch.

729-5.3 Enclosures: Furnish and install NEMA KS 1 type enclosure.

729-5.4 Installation: Install disconnect switches where indicated in the Contract Document or where required by the Engineer. Use separate conduits for line and load conductors. Install fuses in fusible disconnect switches.

729-6 Supporting and Mounting Devices

Ensure the sizes, and types of anchors, fasteners and supports used are adequate to carry the load of the equipment and conduit, including the wire in the conduit.

Space conduit supports to avoid conflicts with reinforcing steel at 5 feet maximum. For concrete mounting, use anchor bolts and all matching parts and tools recommended by and provided by the same manufacturer, as well as suitable for dynamic loading caused by vibration due to traffic. To mount conduit supports and pull boxes, use 1/4 inch diameter anchor system.

To mount channel lights use minimum 1/2 inch diameter anchor system with 3-1/2 inch embedment and 8 inch edge distance.

Use ASTM 300 series stainless steel conduit straps or hangers held at not less than two points.

Do not use powder-actuated anchors. Do not drill or weld structural steel members. Do not use bolts smaller than 1/4 inch in diameter except as may be necessary to fit the mounting holes in small and light devices. Install surface-mounted boxes with minimum of three anchors.

729-7 Conduit

729-7.1 General: Furnish and install conduit in the quantities and sizes required to complete the work as shown in the Plans and as required by NEC. Use products listed and classified by UL as suitable for purpose specified and shown. Do not use non-metallic flexible conduit, aluminum, or electrical metallic tubing (EMT).

EXHIBIT 5 – SPECIAL PROVISIONS AND CONTRACT REQUIREMENTS

729-7.2 Liquid-Tight Flexible Metal Conduit: Furnish and install, liquid-tight flexible metal conduit of interlocked steel construction with PVC jacket, and fittings meeting the requirements of ANSI/NEMA FB 1.

729-7.3 PVC Conduit: Furnish and install, schedule 80 PVC 3/4 inch minimum diameter conduit meeting the requirements of NEMA TC 2 and fittings and conduit bodies meeting the requirements of ASTM D2467 and NEMA TC 3.

729-7.4 Fiberglass Reinforced Epoxy Conduit: Furnish and install rigid non-metallic fiberglass reinforced epoxy conduit and fittings manufactured in accordance with the applicable standards of ANSI and NEMA TC-14B.

Ensure the conduit has a bell and spigot type coupling and the coupling seal is made rigid by using an adhesive that will provide a water and vapor tight joint with a tensile strength equal to that listed for the conduit. An alternative type assembly may be used by applying a triple seal ribbed gasket of water resistant rubber material. Ensure the gasket is held firmly in place with a compatible adhesive.

Ensure that all fittings, adapters, and bends are manufactured from the same materials as the conduit and conform to the dimensional requirements of NEMA TC-14.

Use only fiberglass reinforced epoxy conduit and fittings made by the same manufacturer to insure proper fit and assembly, listed on the UL approved list and labeled for Type I service sizes 2 to 6 inches.

Ensure that each piece of conduit and fitting is clearly marked with durable contrasting ink, stenciled with the following:

1. Nominal size,
2. Bends to show the degree and radius of curvature,
3. Type: SW or HW,
4. Manufacturers' name or trademark.

729-7.5 Installation: Install conduit in accordance with National Electrical Contractors Association (NECA) "Standard of Installation" and manufacturer's instructions.

Arrange supports to prevent misalignment during wiring installation. Support conduit using straps, lay-in adjustable hangers, clevis hangers, and split hangers. Do not support conduit with wire or perforated pipe straps, plastic straps, or plastic hangers. Ensure that all wire used for temporary supports is removed upon completion of installation.

Install an expansion fitting for specified PVC conduit at all structure expansion joints or where movement between adjacent sections of conduit is expected. Provide certification to the Engineer from the manufacture that the expansion fitting meets the following minimum requirements: compatibility with the connected conduits, water proof, UV protected, and allows longitudinal movement equal to that of the expansion joint or movement expected.

Route exposed conduit parallel and perpendicular to walls or route conduit in the railings. Install conduits to be continuous and watertight between boxes or equipment. Protect conduits at all times from the entrance of water and other foreign matter by being capped or well plugged overnight and when the work is temporarily suspended.

Cut conduit square using saw or pipe cutter; de-burr cut ends. Bring conduit to shoulder of fittings; fasten securely. Use conduit hubs to fasten conduit to metal boxes. Do not install more than the

EXHIBIT 5 – SPECIAL PROVISIONS AND CONTRACT REQUIREMENTS

equivalent of three 90 degree bends (total 270 degrees) between boxes. Use conduit bodies to make sharp changes in direction such as around diaphragms.

Join PVC conduit using cement recommended by manufacturer. Wipe PVC conduit dry and clean before joining. Apply full even coat of cement to entire area inserted in fitting. Allow joint to cure for a minimum of 20 minutes before pulling conductors.

Do not use flexible conduit extensions greater than 24 inches in length. Ensure that all flexible conduit extensions are equipped with bonding jumpers.

Do not allow moisture traps; provide pull box with drain fitting at low points in exposed conduit system.

729-8 Wiring

729-8.1 General: Do not use aluminum conductors. Use only SE or RHW on incoming service and use single conductor with XHHW insulation, unless otherwise noted in the Plans.

Do not use wire smaller than No. 12 AWG.

Furnish insulated conductors of seven or nineteen strand copper with a minimum 98% conductivity and connector accessories for copper in sufficient quantities for a complete installation.

729-8.2 Installation: Use pull boxes wherever necessary to facilitate the installation of the conductors. Do not use condulets for pulling more than ten conductors or for branching conductors.

Splice only in accessible boxes. Make lug connections with high pressure indent connector tools as recommended by the lug manufacturer. Make splices and taps to carry full ampacity of conductors without perceptible temperature rise. Tighten all connections to manufacturer's recommendations. Tape uninsulated conductors and connectors with electrical tape to 150% of the insulation value of conductor. Ensure all splices are waterproof.

Use solderless pressure connectors with insulating covers for No. 8 AWG and smaller wire splices and taps. Use split bolt connectors for No. 6 AWG and larger wire splices and taps.

Pull all conductors into a raceway at the same time. Use soap base wire pulling lubricant for pulling No. 4 AWG and larger wire.

729-8.3 Testing: Test each circuit for continuity and short-circuits for its complete length before being connected to its load.

Inspect wire and cable for physical damage and proper connection.

(78) DIVISION 800: GEOTEXTILE FOR DRAINAGE FILTRATION:

October 15, 1991

A. ACCEPTANCE

The Contractor shall supply to the Resident Engineer, prior to placing the material, certified test results from a recognized laboratory of those tests specified herein. Acceptance will be based on the test results meeting these requirements¹ and the material meeting all stated specifications. The Resident Engineer shall submit the certified test results to the Research and Material Engineer for acceptance. Test data shall be no more than 1 year old at the time it is furnished to the Department. Once a fabric has been accepted, it will be listed on an Approval Sheet, and only those materials listed will be acceptable. Test data must be resubmitted for reapproval every 2 years. No fabric will be used nor will payment be made for fabric until the fabric certification is received and approved by the Research and Materials Engineer. The Department

EXHIBIT 5 – SPECIAL PROVISIONS AND CONTRACT REQUIREMENTS

reserves the right to sample and test any of the fabrics, or other materials used in drainage filtration, at any time.

B. PIPING RESISTANCE (SOIL RETENTION - ALL APPLICATIONS)

1. Soils with 50% or less particles by weight passing U.S. No. 200 sieve:
EOS No. (fabric) \geq 30 U.S. Std. Sieve No.

2. Soils with more than 50% particles by weight passing U.S. No. 200 sieve:
EOS No. (fabric) \geq 50 U.S. Std. Sieve No.

Note:

- a. Whenever possible, fabric with the lowest possible EOS No. should be specified.
- b. When the protected soil contains particles from 1 inch size to those passing the U.S. No. 200 sieve, use only the gradation of soil passing the U.S. No. 4 sieve in selecting the fabric.

C. PERMEABILITY

Critical/Severe Applications *	Normal Applications
$k (fabric) \geq 10 k (soil)^2$	$k (Fabric) \geq k (soil)^2$

*Woven monofilament fabrics only; percent open area \geq 4.0 and EOS No. \leq 100 sieve.

D. CHEMICAL COMPOSITION REQUIREMENTS/CONSIDERATIONS

1. Fibers used in the manufacture of civil engineering fabrics shall consist of long chain synthetic polymers, composed of at least 85% by weight of polyolefins, polyesters, or polyamides. These fabrics shall resist deterioration from ultraviolet exposure.
2. The engineering fabric shall be exposed to ultraviolet radiation (sunlight) for no more than 30 days total in the period of time following manufacture until the fabric is covered with soil, rock, concrete, etc.

E. PHYSICAL PROPERTY REQUIREMENTS (ALL FABRICS)

EXHIBIT 5 – SPECIAL PROVISIONS AND CONTRACT REQUIREMENTS

	Class 1 Fabric ³ Protected	Class 2 Fabric ³ Unprotected
Grab Strength (ASTM D-4632 or ASTM D-1682)	80 lbs.	180 lbs.
Seam Strength ⁴ (ASTM D-4632 or ASTM D-1682)	70 lbs.	160 lbs.
Puncture Strength (ASTM D-3787)	25 lbs.	80 lbs.
Burst Strength (ASTM D-3786)	130 psi.	290 psi.
Trapezoid Tear (ASTM D-4533)	25 lbs.	50 lbs.
Ultraviolet Degradation at 150 hours (ASTM D-4355)	70%	70%

¹ All numerical values represent minimum average roll values (i.e., any roll in a lot should meet or exceed the minimum values in the table). Use values for the weaker principal direction. Lots should be sampled according to ASTM D-4354.

² Permeability should be based on the actual fabric open area available for flow. For example, if 50% of the fabric area is to be covered by flat concrete blocks, the effective flow area is reduced by 50%.

³ Fabric is said to be protected when used in drainage trenches or beneath/behind concrete (Portland or asphalt cement) slabs. All other conditions are said to be unprotected,

Examples of each condition are:

Protected: highway edge drains, blanket drains, smooth stable trenches < 10 feet in depth. In trenches, in which the aggregate is extra sharp, additional puncture resistance may be necessary.

Unprotected: stabilization trenches, interceptor drains on cut slopes, rocky or caving trenches or smooth stable trenches > 10 feet in depth.

⁴ Values apply to both field and manufactured seams.

(79) DIVISION 800: GEOCOMPOSITE WALL DRAIN:

May 6, 2003

A. DESCRIPTION

A geocomposite wall drain is a prefabricated drain system that is used to provide drainage behind retaining walls. The geocomposite drain consists of a flexible plastic drainage core bonded to a non-woven geotextile. Geocomposite wall drains shall be placed continuously along the back of the wall as shown in the plans or as otherwise directed by the Engineer. The Contractor shall furnish all necessary labor, equipment, and materials and perform all operations necessary for the installation of geocomposite wall drains in accordance with the details shown on the plans and with the requirements of this specification.

EXHIBIT 5 – SPECIAL PROVISIONS AND CONTRACT REQUIREMENTS

B. ACCEPTANCE CRITERIA

The Contractor shall supply to the Engineer, prior to placing the material, certified test results of those tests specified herein from a recognized laboratory. Acceptance will be based on the test results meeting the geocomposite system properties, drainage core properties, and geotextile properties stated in this specification. The Engineer shall submit the certified test results to the Research and Material Engineer for acceptance. Test data shall be no more than one year old at the time it is furnished to the Department. Geocomposite wall drains shall not be installed until the material certification is received and approved by the Research and Materials Engineer. The Department reserves the right to sample and test any of the materials used in the geocomposite wall drain system.

Labeling, shipment, and storage of the geocomposite wall drain materials shall follow ASTM D 4837. Product labels shall clearly show the manufacturer or supplier name, style number, and roll number. Geocomposite rolls shall be wrapped with a material that will protect the geocomposite drain from damage due to shipment, water, sunlight, and contaminants. The protective wrapping shall be maintained during periods of shipment and storage.

C. MATERIAL

The geocomposite wall drain shall be prefabricated type made up of a lightweight, high impact polymeric drainage core bonded to the geotextile at intervals not exceeding 1.5 inches. The geocomposite wall drain shall be solid backed allowing drainage of water on only one side. The non-woven geotextile is thermal (heat) bonded or fungicide glue bonded to the polymeric drainage core. The geocomposite product sheets or rolls shall have a minimum width of 3 feet with a minimum coverage area of 40 square feet. A geotextile flap shall be provided along all drainage core edges. This flap shall be of sufficient width for sealing the geocomposite drain edge to prevent soil intrusion into the drainage core during and after installation. The geotextile shall cover the full length of the drainage core.

The wall drainage system shall meet the following geocomposite system properties in addition to the individual component properties of the polymeric drainage core and the non-woven geotextile. All numerical values listed in the required property tables shown below represent minimum average roll values (MARV) per ASTM D 4759 unless indicated otherwise. Values for the weaker principal direction should be used. Testing shall be performed in accordance with the methods referenced in this specification. Sampling of lots shall be in accordance with ASTM D 4354.

GECOMPOSITE SYSTEM PROPERTIES		
TEST	METHOD	LIMIT
Flow Capacity (gpm/ft. width) At a hydraulic gradient of 1.0 and a minimum normal stress of 3600 psf (Normal load maintained for 300 hours or until equilibrium)	ASTM D 4716	14

DRAINAGE CORE PROPERTIES		
TEST	METHOD	LIMIT
Thickness (inches)	ASTM D 1777	0.3 minimum / 0.5 maximum
Compressive Strength (psf) At 20% Deformation (10,000 hour minimum duration)	ASTM D 1621	14,000

EXHIBIT 5 – SPECIAL PROVISIONS AND CONTRACT REQUIREMENTS

GEOTEXTILE PROPERTIES		
TEST	METHOD	LIMIT
AOS (Equiv. U.S. Sieve)	ASTM D 4751	50 maximum average roll value
Permittivity (sec ⁻¹)	ASTM D 4991	1.0
Grab Tensile Strength (lbs.)	ASTM D 4632	80
Grab Tensile Elongation (%)	ASTM D 4632	50
Trapezoidal Tear Strength (lbs.)	ASTM D 4533	40
Puncture Strength (lbs.)	ASTM D 4833	50
Burst Strength (psi)	ASTM D 3786	150
Ultraviolet Stability (%) (Retained strength after 500 hours of exposure)	ASTM D 4355	70

D. CONSTRUCTION REQUIREMENTS - GENERAL

The Contractor shall check the geocomposite wall drain upon delivery to ensure that the proper material has been received. The geocomposite wall drain shall be protected during shipment and storage at the construction site from temperatures greater than 71 °C, mud, dirt, debris, and any other environmental condition that may damage the material's physical property values. The wall drainage system shall be protected from direct sunlight in accordance with the manufacturer's recommendations.

The geocomposite wall drain will be rejected at the time of installation if it has defects, tears, punctures, flaws, deterioration, or damage incurred during manufacture, shipment, or storage. Torn or punctured sections shall be removed or repaired as directed by the Engineer. Any geocomposite wall drain damaged during manufacture, shipment, or storage shall be replaced by the Contractor at no additional cost.

If at any time the Engineer determines that the method of installation does not produce a satisfactory wall drainage system, the Contractor shall alter his method and/or equipment as necessary to comply with this specification.

The geocomposite wall drain shall be installed in accordance with the plans and specifications. The surface that the geocomposite drain will be placed against shall be cleaned by removing all soil, debris, and irregularities that will prevent intimate contact between the surface and the geocomposite drain. The geocomposite wall drain shall be secured to the wall using metal stick clips, adhesives, or as recommended by the manufacturer. The geocomposite wall drain shall be installed so as to allow weepholes, as shown in the plans, to drain water from the drainage core and underdrain pipes.

All joints shall be formed by peeling or trimming the geotextile off the attached section to expose 3 inches of the drainage core. The drainage core of the second section being attached is then overlapped 2 inches over the first drainage core. The joint is then covered by reattaching the geotextile flap and securely fastening it to the lower geotextile by means of a continuous strip of 3 inch wide waterproof plastic tape. Each overlapping course shall be shingled in the direction of water flow. If joints cannot be formed by interlocking the cuspatations, then the drainage core should be butted together and covered with continuous, 6 inch wide geotextile. The geotextile fabric shall be centered over the joint and securely fastened to the two geocomposite drains with 3 inch wide waterproof plastic tape.

All exposed edges of the geocomposite wall drain shall be covered with geotextile by tucking and securing a minimum of 4 inches of geotextile behind the drainage core. This may be done by using the geotextile flaps at the edges or using a 12 inch wide continuous strip in the same manner, taping it to the exposed fabric 4 inches in from the edge with a continuous strip of 3 inch wide waterproof plastic tape, and folding the remaining geotextile and tucking it behind the drainage core edge.

EXHIBIT 5 – SPECIAL PROVISIONS AND CONTRACT REQUIREMENTS

If the geotextile is torn, perforated, or ripped during installation, it shall be patched or replaced as directed by the Engineer. The damaged section shall be cut out and replaced completely or repaired by placing a piece of geotextile over the damaged area and providing a minimum of 4 inches of overlap on all sides over the damaged area and secured with 3 inch wide waterproof plastic tape. Damaged drainage core sections shall be discarded and replaced. Any geocomposite wall drain damaged during installation shall be replaced or repaired by the contractor at no additional cost.

The underdrain pipes and free draining aggregate shall be placed as shown in the plans or as directed by the Engineer. A positive outlet for the water in the geocomposite drain shall be maintained at all locations. Weepholes shall not be sealed or made ineffective by the wall drain material. This may involve making a hole in the drainage core at the weephole location. The geotextile drainage filtration fabric used to envelop the underdrain system shall be tucked 6 inches behind the geocomposite drain and overlapped over the geocomposite drain a distance of 12 inches and continuously secured with 3 inch wide waterproof plastic tape.

Backfill shall be placed immediately over the geocomposite wall drain. The contractor shall backfill against the wall in a manner that does not damage the geocomposite drainage system. Care shall be taken to avoid excessive settlement of the backfill material. The geocomposite wall drain shall not be exposed for more than seven days prior to backfilling. Any geocomposite drainage system component that is damaged during the backfilling operation shall be replaced or repaired as directed by the Engineer.

E. METHOD OF MEASUREMENT AND BASIS OF PAYMENT

Geocomposite wall drains will not be measured for payment. The cost of the geocomposite wall drain shall be included in the cost of the retaining wall or wall system where the drainage system is being installed.

(80) SECTION 805: THREAD LOCKING GUARDRAIL HARDWARE:

Use a permanent thread locking compound meeting Military Specification Mil-S-46163A Type I, Grade L. Follow the thread locking compound manufacturer's directions and apply compound to all the fasteners within Type T End Treatments, Impact Attenuators, and Crash Cushions. Apply compound to all guardrail fasteners across bridges or on base plate mounted posts, or in locations directed by the Resident Construction Engineer.

(81) SECTION 805: TL3 TYPE T TANGENT END TERMINALS:

Qualified Product List 49 provides minimum length of continuous w-beam from the impact head for each proprietary Test Level 3 product. All radius, kinks, and transition sections must occur outside of the continuous w-beam section. SCDOT Standard Drawing 805-710-00 shows the required installation for systems with a 50' w-beam requirement. Where the design requires immediate transition from w-beam to thrie-beam at the end of the Type-T, confirm that adequate space exists in advance of the impact head before selecting a system that requires any length greater than 50'. The pay length for the TL3 Type T end terminal is shown in Special Provision Drawing 805-710-SP. No additional measurement or payment will be made for additional w-beam required by the selection of a proprietary product. Where sites do not accommodate longer end treatments, use a system with a 50' continuous w-beam section. When design includes a tangent installation of standard w-beam rail behind the 50' section, the designed rail will be measured and paid at 50' from the impact head as shown in the plan quantities.

For products with a 62'-6" requirement, see drawing 805-710-SP in Attachment B for additional guidance.

(82) SECTION 805: RESETTING GUARDRAIL:

Existing steel beam guardrail that is determined to be in acceptable condition by the RCE, using the below criteria, may be reset in conformance with Section 805.4.3 of the 2007 SCDOT Standard

EXHIBIT 5 – SPECIAL PROVISIONS AND CONTRACT REQUIREMENTS

Specifications. The Contractor shall inspect all guardrail on the project and notify the RCE in writing of any guardrail that will be permanently reset. Provide this notice to the RCE a minimum of two weeks prior to permanently resetting any guardrail on the project. If existing wood posts are planned to be reset, all existing wood posts shall be replaced with steel posts.

Resetting Guardrail Acceptance Criteria:

- A. Any guardrail components that are bent, flattened, torn, deformed, exhibit signs of rust, or damaged in any way shall not be reset.
- B. Guardrail with obsolete components and guardrail systems that are not on the SCDOT Qualified Products List (QPL) shall not be reset.
- C. Section 805.4.3 disallows resetting guardrail posts. This shall only apply to existing wood posts.

(83) SECTION 806: REPAIR EXISTING CONTROL OF ACCESS FENCE:

Repair, replace or reset any damaged control of access fencing or fence components within the project limits, as directed by the RCE. Remove and dispose of existing fences, trees, brush, stumps, logs, weeds, or other debris that interfere with the construction of the fence. CONTRACTOR's bid shall include 1000 linear feet of Repair of Existing Control of Access Fence. Should the actual length of fence rehabilitation vary from this estimated value by more than 25%, a change order will be generated by the RCE to adjust the contract value based on the actual rehabilitated length of fence as measured by SCDOT inspectors, utilizing a unit price of **\$15.00/LF**, regardless of fence type. Ensure all waste materials and debris generated during this work is disposed of promptly and at appropriate waste facilities.

(84) SECTION 809: RIGHT OF WAY PLAT:

A. DESCRIPTION

The contractor by the "Substantial Work Complete" date shall prepare a right of way plat signed and sealed by a Professional Land Surveyor (PLS) licensed to practice in the state of South Carolina. The right of way plat shall be in accordance with the requirements of Section 49-460-A "General Property Survey" as outlined in the South Carolina "Standards of Practice Manual" for land surveyors. A copy of the plat will be recorded, by the contractor, in the Register Mesne Conveyance (RMC) office of the county or counties in which the project resides. The contractor will provide one copy of the plat on a full sized plan sheet(s) (22" X 36") and submit to the resident construction engineer to be included in the as-built plans.

B. MATERIALS: REBAR CAP R/W MARKER

Materials used shall comply with those listed on SCDOT Standard Drawing Nos. 809-10500or 809-110-00.

C. CONSTRUCTION REQUIREMENT

The PLS shall set right of way markers along all new right of way lines as well as along any present right of way being retained by the Department at intervals listed on the SCDOT Standard Drawings. Right of way markers shall not be placed at points common to side property lines and/or corners. In the event that the plan reflects a break in the right of way along a side property line the right of way marker will not be set without the side property line being retraced and established by way of survey. The PLS shall prepare a plat documenting the location of all Right of Way Markers set and reflecting the as-built station and offset from the plan alignment. The plat shall show the entire project corridor as an enclosed strip or parcel of land to include the mainline and all side roads as defined on the project plan.

D. MEASUREMENT AND BASIS OF PAYMENT

The item Right of Way Plat is paid on a lump sum (LS) basis; and therefore, there is no specific measurement for this item. The unit price bid for Property Right of Way Plat shall include all costs for labor, materials, equipment, services of a PLS and any related fees or costs associated with producing a plat, recording the plat at the RMC office, and all required copies. Each marker placed in accordance with the Standard Drawings complete and accepted will be measured and paid at the unit price bid.

EXHIBIT 5 – SPECIAL PROVISIONS AND CONTRACT REQUIREMENTS

Bid Item Number	Description	Unit
8091010	RIGHT OF WAY MARKER (REBAR AND CAP)	EA
8091000	RIGHT OF WAY MARKER (REINFORCED CONCRETE)	EA
8091050	RIGHT OF WAY PLAT	LS

(85) SECTION 815: ANIONIC POLYACRYLAMIDE FOR EROSION CONTROL:

E. DESCRIPTION

This work consists of applying a product containing anionic polyacrylamide to disturbed land areas as a means of controlling erosion. The work also consists of the use of solid form anionic polyacrylamide as a means of sediment control.

F. MATERIALS

The product to be used is to be specific to the area to be treated. Product selection and application rate is to be determined by a testing laboratory acceptable to SCDOT. Preliminary site-specific assessment (soil and water testing) by a qualified manufacturer must be conducted to select media, additives, application rate, application method and maintenance procedure tailored to site-specific soil characteristics, topography, hydrology, and the type of erosion targeted. A copy of the test results is to be provided to the Engineer.

Anionic polyacrylamide, in pure form, shall have less than or equal to 0.05% acrylamide monomer by weight, as established by the Food and Drug Administration and the Environmental Protection Agency. The maximum application rate of polyacrylamide, in pure form, shall not exceed 200 pounds/acre/year, or 10 pounds/acre per single application event.

The polyacrylamide shall have a charge density of 10% to 55%, by weight. The polyacrylamide shall have a molecular weight of 6 to 24 Mg/mole.

The polyacrylamide and polyacrylamide mixtures shall be noncombustible.

Cationic forms of polyacrylamide are not allowed for use due to their high level of toxicity.

Polyacrylamide shall be non-toxic. A toxicity report is required to be submitted to the Engineer.

G. CONSTRUCTION REQUIREMENTS

Liquid and powder forms of polyacrylamide are to be either applied directly to the exposed soil surface or applied as a tackifier with temporary seeding to prevent detachment of soil particles during the establishment of vegetation.

In the solid form, the polymer is to be placed directly into the storm water runoff to enhance eroded particle settlement in a trapping device.

Polyacrylamide shall be mixed and/or applied in accordance with all Occupational Safety and Health Administration (OSHA) Material Safety Data Sheet (MSDS) requirements and the manufacturer's recommendations for the specified use conforming to all federal, state and local laws, rules and regulations. The Contractor is responsible for obtaining all required permits.

Emulsion batches shall be mixed following recommendations of a testing laboratory that determines the proper product and rate to meet site requirements.

Additives such as fertilizers, solubility promoters, or inhibitors, etc. to polyacrylamide shall be nontoxic.

Care is to be taken when using polyacrylamide adjacent to natural water bodies.

EXHIBIT 5 – SPECIAL PROVISIONS AND CONTRACT REQUIREMENTS

H. METHOD OF MEASUREMENT

The application of polyacrylamide for erosion control will be measured by the surface area treated at the recommended rate of application. Quantities are to be computed to the nearest MSY (Thousand Square Yards). Solid form anionic polyacrylamide is to be measured by weight in pounds, in place and accepted. The Contractor is required to provide, to the Engineer, invoices for all polyacrylamide products used on the project.

I. BASIS OF PAYMENT

The accepted quantity of “Anionic Polyacrylamide For Erosion Control” will be paid at the contract unit price, which price and payment shall be full compensation for all materials, labor, tools equipment, and incidentals necessary to complete the work herein described in a workmanlike and acceptable manner. Solid form anionic polyacrylamide is to be paid for by the pound. Bid Item Numbers and Descriptions are as follows:

Bid Item Number	Description	Unit
8152020	ANIONIC POLYACRYLAMIDE FOR EROSION CONTROL	MSY
8152025	SOLID FORM ANIONIC POLYACRYLAMIDE	LBS

(86) SECTION 815: EROSION CONTROL MEASURES:

In addition to the erosion control measures specified in the Plans, Standard Specifications, Supplemental Technical Specifications and the Special Provisions, the CONTRACTOR is advised that all land disturbing activities (clearing and grubbing, excavation, borrow and fill) are subject to the requirements set forth in the following permits and regulations:

- A. South Carolina Code of Regulations 63-380, Standard Plan for Erosion, Sediment, and Stormwater Runoff Control.
- B. Erosion and Sediment Reduction Act of 1983 (Title 48, Chapter 18 of the South Carolina Code of Laws of 1983, as amended). Section 70 of this code authorized the South Carolina Department of Health and Environmental Control (SCDHEC) to administer this regulation with respect to lands under the jurisdiction of the South Carolina Department of Transportation.
- C. National Pollutant Discharge Elimination System (NPDES) General Permit Number SCR160000, effective January 1, 2013: The Environmental Protection Agency, in accordance with the Federal Clean Water Act, has granted to the South Carolina Department of Health and Environmental Control (SCDHEC) the authority to administer the Federal NPDES permit program in the State of South Carolina.

In accordance with the NPDES General Permit, the Contractor must sign a Contractor Certification. The Contractor shall refer to Attachment B for the certification form. By signing this form, the Contractor acknowledges that upon award and execution of the Contract, he/she accepts/ understands the terms and conditions of the *Storm Water Pollution Prevention Plan (SWPPP)* as required by the NPDES General Permit and may be legally accountable to SCDHEC for compliance with the terms and conditions of the *SWPPP*. In addition, the Contractor certifies that the NPDES certification statement status is made part of all its subcontracts.

The Contractor will complete and forward an updated SCDOT approved *Notice of Intent (NOI)* to the SCDOT Construction office to submit to SCDHEC. If the Coastal Zone Consistency (CZC) permit has not been approved it shall be forwarded by the Contractor to SCDOT to submit to SCDHEC as part of *NOI* package. If SCDHEC does not send a letter within 10 business days of receipt of the *NOI*, authorizing coverage, denying coverage, or advising that a review of the *CECP* will take place, coverage will be automatically granted.

Prepare and submit a *Contractor's Erosion Control Plan (CECP)* to the RCE before the pre-construction conference. Ensure that the plan meets the requirements of the NPDES General Permit. The plan will be reviewed and approved by the Department before commencing any land disturbing activities.

EXHIBIT 5 – SPECIAL PROVISIONS AND CONTRACT REQUIREMENTS

At the pre-construction conference, with contactors performing land-disturbing activities present, the *CECP* will be explained and discussed so that the Contractor is made aware of their responsibilities in the *CECP*.

Once approved, fully implement the *CECP*. Coordinate the prompt installation of erosion control devices with construction activities to maintain compliance with the above regulations and NPDES General Permit.

Conduct an Erosion and Sediment Control Inspection by an appointed Certified Erosion Prevention and Sediment Control Inspector (CEPSCI) from the Contractor and the Department at least every 7-calendar days. Both parties will acknowledge participation in the inspection by signing the inspection report and include their inspector's CEPSCI number on the report. Correct deficiencies noted during these inspections within the assigned priority period. If deficiencies are not corrected within this timeframe, the RCE will stop all work (except erosion and sediment control measures) until the deficiencies are corrected.

Give special attention to critical areas within the project limits (i.e., running streams, water bodies, wetlands, etc.). In these areas, the RCE may direct the Contractor to undertake immediate corrective action, but in no case allow these deficiencies to remain unresolved more than 7 days or 48 hours in accordance with their assigned priority after being identified during the Erosion and Sediment Control Inspection.

Closely follow the grading operations with the seeding operations. Shape and prepare the slopes for seeding as the grading progresses. Unless the RCE grants prior written approval, limit the amount of surface area exposed by land disturbing activities to 750,000 square feet. Commence seeding operations within 7 days following completion of construction activities within an area.

Initiate stabilization measures within 7 days for an area where construction activities will be temporarily or permanently ceased for 14 days or longer.

Coordinate the installation of all other permanent erosion control items with the grading and seeding operations. These items include, but are not limited to, asphalt gutter and riprap. Construct gutter work before or promptly after the seeding is performed. Place riprap at the ends of pipe immediately after the pipe is laid and promptly install riprap ditch checks after ditch work has been performed.

Within existing right of way, clean and repair existing concrete paved ditches that will be retained. Within existing right of way, clean and repair existing asphalt paved ditches that are to be retained and overlay with 200 lbs/sy HMA Surface Course Type C or D. Stabilize new ditches in accordance with the *SCDOT Requirements for Hydraulic Design Studies* (May 26, 2009), the *SCDOT Water Quality Design Manual* (December 2014) and as needed for erosion control utilizing SCDHEC Best Management Practices (BMP's).

Failure to adequately comply with the provisions as detailed above or any other required erosion control measures will result in stoppage of all contract operations (except erosion and sediment control measures) until corrective action has been taken. Additional sanctions may be invoked by the SCDHEC in accordance with their authority.

Keep the following documents at the RCE's office from the start of construction until the site is finally stabilized:

EXHIBIT 5 – SPECIAL PROVISIONS AND CONTRACT REQUIREMENTS
--

- A. Copy of the *CECP*,
- B. Copies of Contractor Certification statements,
- C. Copy of the permit,
- D. Letter from DHEC authorizing permit coverage if provided by SCDHEC, and
- E. A marked-up set of site plans.

When uniform perennial vegetation achieves a cover density of 70%, submit a *Notice of Termination (NOT)* to SCDHEC to terminate coverage. Include a signed statement with the *NOT* certifying that all work on the site has been completed in accordance with the *SWPPP* and the NPDES General Permit for all sites one acre or greater.

Fines assessed on the Department by SCDHEC as the result of the CONTRACTOR's non-compliance or violation of said permit provisions will be paid by the Department and will subsequently be deducted from any monies due or that may become due to the CONTRACTOR. In case no monies are due or available, the fines incurred will be charged against the CONTRACTOR's Surety.

REQUIRED CONTRACT PROVISIONS FEDERAL-AID CONSTRUCTION CONTRACTS

- I. General
- II. Nondiscrimination
- III. Nonsegregated Facilities
- IV. Davis-Bacon and Related Act Provisions
- V. Contract Work Hours and Safety Standards Act Provisions
- VI. Subletting or Assigning the Contract
- VII. Safety: Accident Prevention
- VIII. False Statements Concerning Highway Projects
- IX. Implementation of Clean Air Act and Federal Water Pollution Control Act
- X. Compliance with Governmentwide Suspension and Debarment Requirements
- XI. Certification Regarding Use of Contract Funds for Lobbying

contract, suspension / debarment or any other action determined to be appropriate by the contracting agency and FHWA.

4. Selection of Labor: During the performance of this contract, the contractor shall not use convict labor for any purpose within the limits of a construction project on a Federal-aid highway unless it is labor performed by convicts who are on parole, supervised release, or probation. The term Federal-aid highway does not include roadways functionally classified as local roads or rural minor collectors.

ATTACHMENTS

A. Employment and Materials Preference for Appalachian Development Highway System or Appalachian Local Access Road Contracts (included in Appalachian contracts only)

II. NONDISCRIMINATION

The provisions of this section related to 23 CFR Part 230 are applicable to all Federal-aid construction contracts and to all related construction subcontracts of \$10,000 or more. The provisions of 23 CFR Part 230 are not applicable to material supply, engineering, or architectural service contracts.

I. GENERAL

1. Form FHWA-1273 must be physically incorporated in each construction contract funded under Title 23 (excluding emergency contracts solely intended for debris removal). The contractor (or subcontractor) must insert this form in each subcontract and further require its inclusion in all lower tier subcontracts (excluding purchase orders, rental agreements and other agreements for supplies or services).

In addition, the contractor and all subcontractors must comply with the following policies: Executive Order 11246, 41 CFR 60, 29 CFR 1625-1627, Title 23 USC Section 140, the Rehabilitation Act of 1973, as amended (29 USC 794), Title VI of the Civil Rights Act of 1964, as amended, and related regulations including 49 CFR Parts 21, 26 and 27; and 23 CFR Parts 200, 230, and 633.

The applicable requirements of Form FHWA-1273 are incorporated by reference for work done under any purchase order, rental agreement or agreement for other services. The prime contractor shall be responsible for compliance by any subcontractor, lower-tier subcontractor or service provider.

The contractor and all subcontractors must comply with: the requirements of the Equal Opportunity Clause in 41 CFR 60-1.4(b) and, for all construction contracts exceeding \$10,000, the Standard Federal Equal Employment Opportunity Construction Contract Specifications in 41 CFR 60-4.3.

Form FHWA-1273 must be included in all Federal-aid design-build contracts, in all subcontracts and in lower tier subcontracts (excluding subcontracts for design services, purchase orders, rental agreements and other agreements for supplies or services). The design-builder shall be responsible for compliance by any subcontractor, lower-tier subcontractor or service provider.

Note: The U.S. Department of Labor has exclusive authority to determine compliance with Executive Order 11246 and the policies of the Secretary of Labor including 41 CFR 60, and 29 CFR 1625-1627. The contracting agency and the FHWA have the authority and the responsibility to ensure compliance with Title 23 USC Section 140, the Rehabilitation Act of 1973, as amended (29 USC 794), and Title VI of the Civil Rights Act of 1964, as amended, and related regulations including 49 CFR Parts 21, 26 and 27; and 23 CFR Parts 200, 230, and 633.

Contracting agencies may reference Form FHWA-1273 in bid proposal or request for proposal documents, however, the Form FHWA-1273 must be physically incorporated (not referenced) in all contracts, subcontracts and lower-tier subcontracts (excluding purchase orders, rental agreements and other agreements for supplies or services related to a construction contract).

The following provision is adopted from 23 CFR 230, Appendix A, with appropriate revisions to conform to the U.S. Department of Labor (US DOL) and FHWA requirements.

2. Subject to the applicability criteria noted in the following sections, these contract provisions shall apply to all work performed on the contract by the contractor's own organization and with the assistance of workers under the contractor's immediate superintendence and to all work performed on the contract by piecework, station work, or by subcontract.

1. Equal Employment Opportunity: Equal employment opportunity (EEO) requirements not to discriminate and to take affirmative action to assure equal opportunity as set forth under laws, executive orders, rules, regulations (28 CFR 35, 29 CFR 1630, 29 CFR 1625-1627, 41 CFR 60 and 49 CFR 27) and orders of the Secretary of Labor as modified by the

3. A breach of any of the stipulations contained in these Required Contract Provisions may be sufficient grounds for withholding of progress payments, withholding of final payment, termination of the

EXHIBIT 5 – SPECIAL PROVISIONS AND CONTRACT REQUIREMENTS

provisions prescribed herein, and imposed pursuant to 23 U.S.C. 140 shall constitute the EEO and specific affirmative action standards for the contractor's project activities under this contract. The provisions of the Americans with Disabilities Act of 1990 (42 U.S.C. 12101 et seq.) set forth under 28 CFR 35 and 29 CFR 1630 are incorporated by reference in this contract. In the execution of this contract, the contractor agrees to comply with the following minimum specific requirement activities of EEO:

a. The contractor will work with the contracting agency and the Federal Government to ensure that it has made every good faith effort to provide equal opportunity with respect to all of its terms and conditions of employment and in their review of activities under the contract.

b. The contractor will accept as its operating policy the following statement:

"It is the policy of this Company to assure that applicants are employed, and that employees are treated during employment, without regard to their race, religion, sex, color, national origin, age or disability. Such action shall include: employment, upgrading, demotion, or transfer; recruitment or recruitment advertising; layoff or termination; rates of pay or other forms of compensation; and selection for training, including apprenticeship, pre-apprenticeship, and/or on-the-job training."

2. EEO Officer: The contractor will designate and make known to the contracting officers an EEO Officer who will have the responsibility for and must be capable of effectively administering and promoting an active EEO program and who must be assigned adequate authority and responsibility to do so.

3. Dissemination of Policy: All members of the contractor's staff who are authorized to hire, supervise, promote, and discharge employees, or who recommend such action, or who are substantially involved in such action, will be made fully cognizant of, and will implement, the contractor's EEO policy and contractual responsibilities to provide EEO in each grade and classification of employment. To ensure that the above agreement will be met, the following actions will be taken as a minimum:

a. Periodic meetings of supervisory and personnel office employees will be conducted before the start of work and then not less often than once every six months, at which time the contractor's EEO policy and its implementation will be reviewed and explained. The meetings will be conducted by the EEO Officer.

b. All new supervisory or personnel office employees will be given a thorough indoctrination by the EEO Officer, covering all major aspects of the contractor's EEO obligations within thirty days following their reporting for duty with the contractor.

c. All personnel who are engaged in direct recruitment for the project will be instructed by the EEO Officer in the contractor's procedures for locating and hiring minorities and women.

d. Notices and posters setting forth the contractor's EEO policy will be placed in areas readily accessible to employees, applicants for employment and potential employees.

e. The contractor's EEO policy and the procedures to implement such policy will be brought to the attention of employees by means of meetings, employee handbooks, or other appropriate means.

4. Recruitment: When advertising for employees, the contractor will include in all advertisements for employees the notation: "An Equal Opportunity Employer." All such advertisements will be placed in publications having a large circulation among minorities and women in the area from which the project work force would normally be derived.

a. The contractor will, unless precluded by a valid bargaining agreement, conduct systematic and direct recruitment through public and private employee referral sources likely to yield qualified minorities and women. To meet this requirement, the contractor will identify sources of potential minority group employees, and establish with such identified sources procedures whereby minority and women applicants may be referred to the contractor for employment consideration.

b. In the event the contractor has a valid bargaining agreement providing for exclusive hiring hall referrals, the contractor is expected to observe the provisions of that agreement to the extent that the system meets the contractor's compliance with EEO contract provisions. Where implementation of such an agreement has the effect of discriminating against minorities or women, or obligates the contractor to do the same, such implementation violates Federal nondiscrimination provisions.

c. The contractor will encourage its present employees to refer minorities and women as applicants for employment. Information and procedures with regard to referring such applicants will be discussed with employees.

5. Personnel Actions: Wages, working conditions, and employee benefits shall be established and administered, and personnel actions of every type, including hiring, upgrading, promotion, transfer, demotion, layoff, and termination, shall be taken without regard to race, color, religion, sex, national origin, age or disability. The following procedures shall be followed:

a. The contractor will conduct periodic inspections of project sites to insure that working conditions and employee facilities do not indicate discriminatory treatment of project site personnel.

b. The contractor will periodically evaluate the spread of wages paid within each classification to determine any evidence of discriminatory wage practices.

c. The contractor will periodically review selected personnel actions in depth to determine whether there is evidence of discrimination. Where evidence is found, the contractor will promptly take corrective action. If the review indicates that the discrimination may extend beyond the actions reviewed, such corrective action shall include all affected persons.

d. The contractor will promptly investigate all complaints of alleged discrimination made to the contractor in connection with its obligations under this contract, will attempt to resolve such complaints, and will take appropriate corrective action within a reasonable time. If the investigation indicates that the discrimination may affect persons other than the complainant, such corrective action shall include such other persons. Upon completion of each investigation, the contractor will inform every complainant of all of their avenues of appeal.

6. Training and Promotion:

a. The contractor will assist in locating, qualifying, and increasing the skills of minorities and women who are applicants for employment or current employees. Such efforts should be aimed at

EXHIBIT 5 – SPECIAL PROVISIONS AND CONTRACT REQUIREMENTS

developing full journey level status employees in the type of trade or job classification involved.

b. Consistent with the contractor's work force requirements and as permissible under Federal and State regulations, the contractor shall make full use of training programs, i.e., apprenticeship, and on-the-job training programs for the geographical area of contract performance. In the event a special provision for training is provided under this contract, this subparagraph will be superseded as indicated in the special provision. The contracting agency may reserve training positions for persons who receive welfare assistance in accordance with 23 U.S.C. 140(a).

c. The contractor will advise employees and applicants for employment of available training programs and entrance requirements for each.

d. The contractor will periodically review the training and promotion potential of employees who are minorities and women and will encourage eligible employees to apply for such training and promotion.

7. Unions: If the contractor relies in whole or in part upon unions as a source of employees, the contractor will use good faith efforts to obtain the cooperation of such unions to increase opportunities for minorities and women. Actions by the contractor, either directly or through a contractor's association acting as agent, will include the procedures set forth below:

a. The contractor will use good faith efforts to develop, in cooperation with the unions, joint training programs aimed toward qualifying more minorities and women for membership in the unions and increasing the skills of minorities and women so that they may qualify for higher paying employment.

b. The contractor will use good faith efforts to incorporate an EEO clause into each union agreement to the end that such union will be contractually bound to refer applicants without regard to their race, color, religion, sex, national origin, age or disability.

c. The contractor is to obtain information as to the referral practices and policies of the labor union except that to the extent such information is within the exclusive possession of the labor union and such labor union refuses to furnish such information to the contractor, the contractor shall so certify to the contracting agency and shall set forth what efforts have been made to obtain such information.

d. In the event the union is unable to provide the contractor with a reasonable flow of referrals within the time limit set forth in the collective bargaining agreement, the contractor will, through independent recruitment efforts, fill the employment vacancies without regard to race, color, religion, sex, national origin, age or disability; making full efforts to obtain qualified and/or qualifiable minorities and women. The failure of a union to provide sufficient referrals (even though it is obligated to provide exclusive referrals under the terms of a collective bargaining agreement) does not relieve the contractor from the requirements of this paragraph. In the event the union referral practice prevents the contractor from meeting the obligations pursuant to Executive Order 11246, as amended, and these special provisions, such contractor shall immediately notify the contracting agency.

8. Reasonable Accommodation for Applicants / Employees with Disabilities: The contractor must be familiar with the requirements for and comply with the Americans with Disabilities Act and all rules and regulations established there under. Employers must provide reasonable accommodation in all employment activities unless to do so would cause an undue hardship.

9. Selection of Subcontractors, Procurement of Materials and Leasing of Equipment: The contractor shall not discriminate on the

grounds of race, color, religion, sex, national origin, age or disability in the selection and retention of subcontractors, including procurement of materials and leases of equipment. The contractor shall take all necessary and reasonable steps to ensure nondiscrimination in the administration of this contract.

a. The contractor shall notify all potential subcontractors and suppliers and lessors of their EEO obligations under this contract.

b. The contractor will use good faith efforts to ensure subcontractor compliance with their EEO obligations.

10. Assurance Required by 49 CFR 26.13(b):

a. The requirements of 49 CFR Part 26 and the State DOT's U.S. DOT-approved DBE program are incorporated by reference.

b. The contractor or subcontractor shall not discriminate on the basis of race, color, national origin, or sex in the performance of this contract. The contractor shall carry out applicable requirements of 49 CFR Part 26 in the award and administration of DOT-assisted contracts. Failure by the contractor to carry out these requirements is a material breach of this contract, which may result in the termination of this contract or such other remedy as the contracting agency deems appropriate.

11. Records and Reports: The contractor shall keep such records as necessary to document compliance with the EEO requirements. Such records shall be retained for a period of three years following the date of the final payment to the contractor for all contract work and shall be available at reasonable times and places for inspection by authorized representatives of the contracting agency and the FHWA.

a. The records kept by the contractor shall document the following:

(1) The number and work hours of minority and non-minority group members and women employed in each work classification on the project;

(2) The progress and efforts being made in cooperation with unions, when applicable, to increase employment opportunities for minorities and women; and

(3) The progress and efforts being made in locating, hiring, training, qualifying, and upgrading minorities and women;

b. The contractors and subcontractors will submit an annual report to the contracting agency each July for the duration of the project, indicating the number of minority, women, and non-minority group employees currently engaged in each work classification required by the contract work. This information is to be reported on [Form FHWA-1391](#). The staffing data should represent the project work force on board in all or any part of the last payroll period preceding the end of July. If on-the-job training is being required by special provision, the contractor will be required to collect and report training data. The employment data should reflect

EXHIBIT 5 – SPECIAL PROVISIONS AND CONTRACT REQUIREMENTS

the work force on board during all or any part of the last payroll period preceding the end of July.

III. NONSEGREGATED FACILITIES

This provision is applicable to all Federal-aid construction contracts and to all related construction subcontracts of \$10,000 or more.

The contractor must ensure that facilities provided for employees are provided in such a manner that segregation on the basis of race, color, religion, sex, or national origin cannot result. The contractor may neither require such segregated use by written or oral policies nor tolerate such use by employee custom. The contractor's obligation extends further to ensure that its employees are not assigned to perform their services at any location, under the contractor's control, where the facilities are segregated. The term "facilities" includes waiting rooms, work areas, restaurants and other eating areas, time clocks, restrooms, washrooms, locker rooms, and other storage or dressing areas, parking lots, drinking fountains, recreation or entertainment areas, transportation, and housing provided for employees. The contractor shall provide separate or single-user restrooms and necessary dressing or sleeping areas to assure privacy between sexes.

IV. Davis-Bacon and Related Act Provisions

This section is applicable to all Federal-aid construction projects exceeding \$2,000 and to all related subcontracts and lower-tier subcontracts (regardless of subcontract size). The requirements apply to all projects located within the right-of-way of a roadway that is functionally classified as Federal-aid highway. This excludes roadways functionally classified as local roads or rural minor collectors, which are exempt. Contracting agencies may elect to apply these requirements to other projects.

The following provisions are from the U.S. Department of Labor regulations in 29 CFR 5.5 "Contract provisions and related matters" with minor revisions to conform to the FHWA-1273 format and FHWA program requirements.

1. Minimum wages

a. All laborers and mechanics employed or working upon the site of the work, will be paid unconditionally and not less often than once a week, and without subsequent deduction or rebate on any account (except such payroll deductions as are permitted by regulations issued by the Secretary of Labor under the Copeland Act (29 CFR part 3)), the full amount of wages and bona fide fringe benefits (or cash equivalents thereof) due at time of payment computed at rates not less than those contained in the wage determination of the Secretary of Labor which is attached hereto and made a part hereof, regardless of any contractual relationship which may be alleged to exist between the contractor and such laborers and mechanics.

Contributions made or costs reasonably anticipated for bona fide fringe benefits under section 1(b)(2) of the Davis-Bacon Act on behalf of laborers or mechanics are considered wages paid to such laborers or mechanics, subject to the provisions of paragraph 1.d. of this section; also, regular contributions made or costs incurred for more than a weekly period (but not less often than quarterly) under plans, funds, or programs which cover the particular weekly period, are deemed to be constructively made or incurred during such weekly period. Such laborers and mechanics shall be paid the appropriate wage rate and fringe benefits on the wage determination for the classification of work actually performed, without regard to skill, except as provided in 29 CFR 5.5(a)(4). Laborers or mechanics performing work in more than one classification may be

compensated at the rate specified for each classification for the time actually worked therein: Provided, That the employer's payroll records accurately set forth the time spent in each classification in which work is performed. The wage determination (including any additional classification and wage rates conformed under paragraph 1.b. of this section) and the Davis-Bacon poster (WH-1321) shall be posted at all times by the contractor and its subcontractors at the site of the work in a prominent and accessible place where it can be easily seen by the workers.

b. (1) The contracting officer shall require that any class of laborers or mechanics, including helpers, which is not listed in the wage determination and which is to be employed under the contract shall be classified in conformance with the wage determination. The contracting officer shall approve an additional classification and wage rate and fringe benefits therefore only when the following criteria have been met:

(i) The work to be performed by the classification requested is not performed by a classification in the wage determination; and

(ii) The classification is utilized in the area by the construction industry; and

(iii) The proposed wage rate, including any bona fide fringe benefits, bears a reasonable relationship to the wage rates contained in the wage determination.

(2) If the contractor and the laborers and mechanics to be employed in the classification (if known), or their representatives, and the contracting officer agree on the classification and wage rate (including the amount designated for fringe benefits where appropriate), a report of the action taken shall be sent by the contracting officer to the Administrator of the Wage and Hour Division, Employment Standards Administration, U.S. Department of Labor, Washington, DC 20210. The Administrator, or an authorized representative, will approve, modify, or disapprove every additional classification action within 30 days of receipt and so advise the contracting officer or will notify the contracting officer within the 30-day period that additional time is necessary.

(3) In the event the contractor, the laborers or mechanics to be employed in the classification or their representatives, and the contracting officer do not agree on the proposed classification and wage rate (including the amount designated for fringe benefits, where appropriate), the contracting officer shall refer the questions, including the views of all interested parties and the recommendation of the contracting officer, to the Wage and Hour Administrator for determination. The Wage and Hour Administrator, or an authorized representative, will issue a determination within 30 days of receipt and so advise the contracting officer or will notify the contracting officer within the 30-day period that additional time is necessary.

EXHIBIT 5 – SPECIAL PROVISIONS AND CONTRACT REQUIREMENTS

(4) The wage rate (including fringe benefits where appropriate) determined pursuant to paragraphs 1.b.(2) or 1.b.(3) of this section, shall be paid to all workers performing work in the classification under this contract from the first day on which work is performed in the classification.

c. Whenever the minimum wage rate prescribed in the contract for a class of laborers or mechanics includes a fringe benefit which is not expressed as an hourly rate, the contractor shall either pay the benefit as stated in the wage determination or shall pay another bona fide fringe benefit or an hourly cash equivalent thereof.

d. If the contractor does not make payments to a trustee or other third person, the contractor may consider as part of the wages of any laborer or mechanic the amount of any costs reasonably anticipated in providing bona fide fringe benefits under a plan or program. Provided, That the Secretary of Labor has found, upon the written request of the contractor, that the applicable standards of the Davis-Bacon Act have been met. The Secretary of Labor may require the contractor to set aside in a separate account assets for the meeting of obligations under the plan or program.

2. Withholding

The contracting agency shall upon its own action or upon written request of an authorized representative of the Department of Labor, withhold or cause to be withheld from the contractor under this contract, or any other Federal contract with the same prime contractor, or any other federally-assisted contract subject to Davis-Bacon prevailing wage requirements, which is held by the same prime contractor, so much of the accrued payments or advances as may be considered necessary to pay laborers and mechanics, including apprentices, trainees, and helpers, employed by the contractor or any subcontractor the full amount of wages required by the contract. In the event of failure to pay any laborer or mechanic, including any apprentice, trainee, or helper, employed or working on the site of the work, all or part of the wages required by the contract, the contracting agency may, after written notice to the contractor, take such action as may be necessary to cause the suspension of any further payment, advance, or guarantee of funds until such violations have ceased.

3. Payrolls and basic records

a. Payrolls and basic records relating thereto shall be maintained by the contractor during the course of the work and preserved for a period of three years thereafter for all laborers and mechanics working at the site of the work. Such records shall contain the name, address, and social security number of each such worker, his or her correct classification, hourly rates of wages paid (including rates of contributions or costs anticipated for bona fide fringe benefits or cash equivalents thereof of the types described in section 1(b)(2)(B) of the Davis-Bacon Act), daily and weekly number of hours worked, deductions made and actual wages paid. Whenever the Secretary of Labor has found under 29 CFR 5.5(a)(1)(iv) that the wages of any laborer or mechanic include the amount of any costs reasonably anticipated in providing benefits under a plan or program described in section 1(b)(2)(B) of the Davis-Bacon Act, the contractor shall maintain records which show that the commitment to provide such benefits is enforceable, that the plan or program is financially responsible, and that the plan or program has been communicated in writing to the laborers or mechanics affected, and records which show the costs anticipated or the actual cost incurred in providing such benefits. Contractors employing apprentices or trainees under approved programs shall maintain written evidence of the registration of apprenticeship programs and certification of trainee programs, the registration of the apprentices and trainees, and the ratios and wage rates prescribed in the applicable programs.

b. (1) The contractor shall submit weekly for each week in which any contract work is performed a copy of all payrolls to the contracting agency. The payrolls submitted shall set out accurately and completely all of the information required to be maintained under 29 CFR 5.5(a)(3)(i), except that full social security numbers and home addresses shall not be included on weekly transmittals. Instead the payrolls shall only need to include an individually identifying number for each employee (e.g. , the last four digits of the employee's social security number). The required weekly payroll information may be submitted in any form desired. Optional Form WH-347 is available for this purpose from the Wage and Hour Division Web site at <http://www.dol.gov/esa/whd/forms/wh347instr.htm> or its successor site. The prime contractor is responsible for the submission of copies of payrolls by all subcontractors. Contractors and subcontractors shall maintain the full social security number and current address of each covered worker, and shall provide them upon request to the contracting agency for transmission to the State DOT, the FHWA or the Wage and Hour Division of the Department of Labor for purposes of an investigation or audit of compliance with prevailing wage requirements. It is not a violation of this section for a prime contractor to require a subcontractor to provide addresses and social security numbers to the prime contractor for its own records, without weekly submission to the contracting agency..

(2) Each payroll submitted shall be accompanied by a "Statement of Compliance," signed by the contractor or subcontractor or his or her agent who pays or supervises the payment of the persons employed under the contract and shall certify the following:

(i) That the payroll for the payroll period contains the information required to be provided under §5.5 (a)(3)(ii) of Regulations, 29 CFR part 5, the appropriate information is being maintained under §5.5 (a)(3)(i) of Regulations, 29 CFR part 5, and that such information is correct and complete;

(ii) That each laborer or mechanic (including each helper, apprentice, and trainee) employed on the contract during the payroll period has been paid the full weekly wages earned, without rebate, either directly or indirectly, and that no deductions have been made either directly or indirectly from the full wages earned, other than permissible deductions as set forth in Regulations, 29 CFR part 3;

(iii) That each laborer or mechanic has been paid not less than the applicable wage rates and fringe benefits or cash equivalents for the classification of work performed, as specified in the applicable wage determination incorporated into the contract.

(3) The weekly submission of a properly executed certification set forth on the reverse side of Optional Form WH-347 shall satisfy the requirement for submission of the "Statement of

EXHIBIT 5 – SPECIAL PROVISIONS AND CONTRACT REQUIREMENTS

Compliance” required by paragraph 3.b.(2) of this section.

(4) The falsification of any of the above certifications may subject the contractor or subcontractor to civil or criminal prosecution under section 1001 of title 18 and section 231 of title 31 of the United States Code.

c. The contractor or subcontractor shall make the records required under paragraph 3.a. of this section available for inspection, copying, or transcription by authorized representatives of the contracting agency, the State DOT, the FHWA, or the Department of Labor, and shall permit such representatives to interview employees during working hours on the job. If the contractor or subcontractor fails to submit the required records or to make them available, the FHWA may, after written notice to the contractor, the contracting agency or the State DOT, take such action as may be necessary to cause the suspension of any further payment, advance, or guarantee of funds. Furthermore, failure to submit the required records upon request or to make such records available may be grounds for debarment action pursuant to 29 CFR 5.12.

4. Apprentices and trainees

a. Apprentices (programs of the USDOL).

Apprentices will be permitted to work at less than the predetermined rate for the work they performed when they are employed pursuant to and individually registered in a bona fide apprenticeship program registered with the U.S. Department of Labor, Employment and Training Administration, Office of Apprenticeship Training, Employer and Labor Services, or with a State Apprenticeship Agency recognized by the Office, or if a person is employed in his or her first 90 days of probationary employment as an apprentice in such an apprenticeship program, who is not individually registered in the program, but who has been certified by the Office of Apprenticeship Training, Employer and Labor Services or a State Apprenticeship Agency (where appropriate) to be eligible for probationary employment as an apprentice.

The allowable ratio of apprentices to journeymen on the job site in any craft classification shall not be greater than the ratio permitted to the contractor as to the entire work force under the registered program. Any worker listed on a payroll at an apprentice wage rate, who is not registered or otherwise employed as stated above, shall be paid not less than the applicable wage rate on the wage determination for the classification of work actually performed. In addition, any apprentice performing work on the job site in excess of the ratio permitted under the registered program shall be paid not less than the applicable wage rate on the wage determination for the work actually performed. Where a contractor is performing construction on a project in a locality other than that in which its program is registered, the ratios and wage rates (expressed in percentages of the journeyman's hourly rate) specified in the contractor's or subcontractor's registered program shall be observed.

Every apprentice must be paid at not less than the rate specified in the registered program for the apprentice's level of progress, expressed as a percentage of the journeymen hourly rate specified in the applicable wage determination. Apprentices shall be paid fringe benefits in accordance with the provisions of the apprenticeship program. If the apprenticeship program does not specify fringe benefits, apprentices must be paid the full amount of fringe benefits listed on the wage determination for the applicable classification. If the Administrator determines that a different practice prevails for the applicable apprentice classification, fringes shall be paid in accordance with that determination.

In the event the Office of Apprenticeship Training, Employer and Labor Services, or a State Apprenticeship Agency recognized by the Office, withdraws approval of an apprenticeship program, the contractor will no longer be permitted to utilize apprentices at less than the applicable predetermined rate for the work performed until an acceptable program is approved.

b. Trainees (programs of the USDOL).

Except as provided in 29 CFR 5.16, trainees will not be permitted to work at less than the predetermined rate for the work performed unless they are employed pursuant to and individually registered in a program which has received prior approval, evidenced by formal certification by the U.S. Department of Labor, Employment and Training Administration.

The ratio of trainees to journeymen on the job site shall not be greater than permitted under the plan approved by the Employment and Training Administration.

Every trainee must be paid at not less than the rate specified in the approved program for the trainee's level of progress, expressed as a percentage of the journeyman hourly rate specified in the applicable wage determination. Trainees shall be paid fringe benefits in accordance with the provisions of the trainee program. If the trainee program does not mention fringe benefits, trainees shall be paid the full amount of fringe benefits listed on the wage determination unless the Administrator of the Wage and Hour Division determines that there is an apprenticeship program associated with the corresponding journeyman wage rate on the wage determination which provides for less than full fringe benefits for apprentices. Any employee listed on the payroll at a trainee rate who is not registered and participating in a training plan approved by the Employment and Training Administration shall be paid not less than the applicable wage rate on the wage determination for the classification of work actually performed. In addition, any trainee performing work on the job site in excess of the ratio permitted under the registered program shall be paid not less than the applicable wage rate on the wage determination for the work actually performed.

In the event the Employment and Training Administration withdraws approval of a training program, the contractor will no longer be permitted to utilize trainees at less than the applicable predetermined rate for the work performed until an acceptable program is approved.

c. Equal employment opportunity. The utilization of apprentices, trainees and journeymen under this part shall be in conformity with the equal employment opportunity requirements of Executive Order 11246, as amended, and 29 CFR part 30.

d. Apprentices and Trainees (programs of the U.S. DOT).

EXHIBIT 5 – SPECIAL PROVISIONS AND CONTRACT REQUIREMENTS

Apprentices and trainees working under apprenticeship and skill training programs which have been certified by the Secretary of Transportation as promoting EEO in connection with Federal-aid highway construction programs are not subject to the requirements of paragraph 4 of this Section IV. The straight time hourly wage rates for apprentices and trainees under such programs will be established by the particular programs. The ratio of apprentices and trainees to journeymen shall not be greater than permitted by the terms of the particular program.

5. Compliance with Copeland Act requirements. The contractor shall comply with the requirements of 29 CFR part 3, which are incorporated by reference in this contract.

6. Subcontracts. The contractor or subcontractor shall insert Form FHWA-1273 in any subcontracts and also require the subcontractors to include Form FHWA-1273 in any lower tier subcontracts. The prime contractor shall be responsible for the compliance by any subcontractor or lower tier subcontractor with all the contract clauses in 29 CFR 5.5.

7. Contract termination: debarment. A breach of the contract clauses in 29 CFR 5.5 may be grounds for termination of the contract, and for debarment as a contractor and a subcontractor as provided in 29 CFR 5.12.

8. Compliance with Davis-Bacon and Related Act requirements. All rulings and interpretations of the Davis-Bacon and Related Acts contained in 29 CFR parts 1, 3, and 5 are herein incorporated by reference in this contract.

9. Disputes concerning labor standards. Disputes arising out of the labor standards provisions of this contract shall not be subject to the general disputes clause of this contract. Such disputes shall be resolved in accordance with the procedures of the Department of Labor set forth in 29 CFR parts 5, 6, and 7. Disputes within the meaning of this clause include disputes between the contractor (or any of its subcontractors) and the contracting agency, the U.S. Department of Labor, or the employees or their representatives.

10. Certification of eligibility.

a. By entering into this contract, the contractor certifies that neither it (nor he or she) nor any person or firm who has an interest in the contractor's firm is a person or firm ineligible to be awarded Government contracts by virtue of section 3(a) of the Davis-Bacon Act or 29 CFR 5.12(a)(1).

b. No part of this contract shall be subcontracted to any person or firm ineligible for award of a Government contract by virtue of section 3(a) of the Davis-Bacon Act or 29 CFR 5.12(a)(1).

c. The penalty for making false statements is prescribed in the U.S. Criminal Code, 18 U.S.C. 1001.

V. CONTRACT WORK HOURS AND SAFETY STANDARDS ACT

The following clauses apply to any Federal-aid construction contract in an amount in excess of \$100,000 and subject to the overtime provisions of the Contract Work Hours and Safety Standards Act. These clauses shall be inserted in addition to the clauses required by 29 CFR 5.5(a) or 29 CFR 4.6. As used in this paragraph, the terms laborers and mechanics include watchmen and guards.

1. Overtime requirements. No contractor or subcontractor contracting for any part of the contract work which may require or involve the employment of laborers or mechanics shall require or permit any such laborer or mechanic in any workweek in which he or she is employed on such work to work in excess of forty hours in such workweek unless such laborer or mechanic receives compensation at a rate not less than one and one-half times the basic rate of pay for all hours worked in excess of forty hours in such workweek.

2. Violation; liability for unpaid wages; liquidated damages. In the event of any violation of the clause set forth in paragraph (1.) of this section, the contractor and any subcontractor responsible therefor shall be liable for the unpaid wages. In addition, such contractor and subcontractor shall be liable to the United States (in the case of work done under contract for the District of Columbia or a territory, to such District or to such territory), for liquidated damages. Such liquidated damages shall be computed with respect to each individual laborer or mechanic, including watchmen and guards, employed in violation of the clause set forth in paragraph (1.) of this section, in the sum of \$10 for each calendar day on which such individual was required or permitted to work in excess of the standard workweek of forty hours without payment of the overtime wages required by the clause set forth in paragraph (1.) of this section.

3. Withholding for unpaid wages and liquidated damages. The FHWA or the contracting agency shall upon its own action or upon written request of an authorized representative of the Department of Labor withhold or cause to be withheld, from any moneys payable on account of work performed by the contractor or subcontractor under any such contract or any other Federal contract with the same prime contractor, or any other federally-assisted contract subject to the Contract Work Hours and Safety Standards Act, which is held by the same prime contractor, such sums as may be determined to be necessary to satisfy any liabilities of such contractor or subcontractor for unpaid wages and liquidated damages as provided in the clause set forth in paragraph (2.) of this section.

4. Subcontracts. The contractor or subcontractor shall insert in any subcontracts the clauses set forth in paragraph (1.) through (4.) of this section and also a clause requiring the subcontractors to include these clauses in any lower tier subcontracts. The prime contractor shall be responsible for compliance by any subcontractor or lower tier subcontractor with the clauses set forth in paragraphs (1.) through (4.) of this section.

VI. SUBLETTING OR ASSIGNING THE CONTRACT

This provision is applicable to all Federal-aid construction contracts on the National Highway System.

1. The contractor shall perform with its own organization contract work amounting to not less than 30 percent (or a greater percentage if specified

EXHIBIT 5 – SPECIAL PROVISIONS AND CONTRACT REQUIREMENTS

elsewhere in the contract) of the total original contract price, excluding any specialty items designated by the contracting agency. Specialty items may be performed by subcontract and the amount of any such specialty items performed may be deducted from the total original contract price before computing the amount of work required to be performed by the contractor's own organization (23 CFR 635.116).

a. The term "perform work with its own organization" refers to workers employed or leased by the prime contractor, and equipment owned or rented by the prime contractor, with or without operators. Such term does not include employees or equipment of a subcontractor or lower tier subcontractor, agents of the prime contractor, or any other assignees. The term may include payments for the costs of hiring leased employees from an employee leasing firm meeting all relevant Federal and State regulatory requirements. Leased employees may only be included in this term if the prime contractor meets all of the following conditions:

- (1) the prime contractor maintains control over the supervision of the day-to-day activities of the leased employees;
- (2) the prime contractor remains responsible for the quality of the work of the leased employees;
- (3) the prime contractor retains all power to accept or exclude individual employees from work on the project; and
- (4) the prime contractor remains ultimately responsible for the payment of predetermined minimum wages, the submission of payrolls, statements of compliance and all other Federal regulatory requirements.

b. "Specialty Items" shall be construed to be limited to work that requires highly specialized knowledge, abilities, or equipment not ordinarily available in the type of contracting organizations qualified and expected to bid or propose on the contract as a whole and in general are to be limited to minor components of the overall contract.

2. The contract amount upon which the requirements set forth in paragraph (1) of Section VI is computed includes the cost of material and manufactured products which are to be purchased or produced by the contractor under the contract provisions.

3. The contractor shall furnish (a) a competent superintendent or supervisor who is employed by the firm, has full authority to direct performance of the work in accordance with the contract requirements, and is in charge of all construction operations (regardless of who performs the work) and (b) such other of its own organizational resources (supervision, management, and engineering services) as the contracting officer determines is necessary to assure the performance of the contract.

4. No portion of the contract shall be sublet, assigned or otherwise disposed of except with the written consent of the contracting officer, or authorized representative, and such consent when given shall not be construed to relieve the contractor of any responsibility for the fulfillment of the contract. Written consent will be given only after the contracting agency has assured that each subcontract is evidenced in writing and that it contains all pertinent provisions and requirements of the prime contract.

5. The 30% self-performance requirement of paragraph (1) is not applicable to design-build contracts; however, contracting agencies may establish their own self-performance requirements.

VII. SAFETY: ACCIDENT PREVENTION

This provision is applicable to all Federal-aid construction contracts and to all related subcontracts.

1. In the performance of this contract the contractor shall comply with all applicable Federal, State, and local laws governing safety, health, and sanitation (23 CFR 635). The contractor shall provide all safeguards, safety devices and protective equipment and take any other needed actions as it determines, or as the contracting officer may determine, to be reasonably necessary to protect the life and health of employees on the job and the safety of the public and to protect property in connection with the performance of the work covered by the contract.

2. It is a condition of this contract, and shall be made a condition of each subcontract, which the contractor enters into pursuant to this contract, that the contractor and any subcontractor shall not permit any employee, in performance of the contract, to work in surroundings or under conditions which are unsanitary, hazardous or dangerous to his/her health or safety, as determined under construction safety and health standards (29 CFR 1926) promulgated by the Secretary of Labor, in accordance with Section 107 of the Contract Work Hours and Safety Standards Act (40 U.S.C. 3704).

3. Pursuant to 29 CFR 1926.3, it is a condition of this contract that the Secretary of Labor or authorized representative thereof, shall have right of entry to any site of contract performance to inspect or investigate the matter of compliance with the construction safety and health standards and to carry out the duties of the Secretary under Section 107 of the Contract Work Hours and Safety Standards Act (40 U.S.C.3704).

VIII. FALSE STATEMENTS CONCERNING HIGHWAY PROJECTS

This provision is applicable to all Federal-aid construction contracts and to all related subcontracts.

In order to assure high quality and durable construction in conformity with approved plans and specifications and a high degree of reliability on statements and representations made by engineers, contractors, suppliers, and workers on Federal-aid highway projects, it is essential that all persons concerned with the project perform their functions as carefully, thoroughly, and honestly as possible. Willful falsification, distortion, or misrepresentation with respect to any facts related to the project is a violation of Federal law. To prevent any misunderstanding regarding the seriousness of these and similar acts, Form FHWA-1022 shall be posted on each Federal-aid highway project (23 CFR 635) in one or more places where it is readily available to all persons concerned with the project:

18 U.S.C. 1020 reads as follows:

"Whoever, being an officer, agent, or employee of the United States, or of any State or Territory, or whoever, whether a person, association, firm, or corporation, knowingly makes any false statement, false representation, or false report as to the character, quality, quantity, or cost of the material used or to be used, or the quantity or quality of the work performed or to be performed, or the cost thereof in connection with the submission of plans, maps, specifications, contracts, or costs of

EXHIBIT 5 – SPECIAL PROVISIONS AND CONTRACT REQUIREMENTS

construction on any highway or related project submitted for approval to the Secretary of Transportation; or

Whoever knowingly makes any false statement, false representation, false report or false claim with respect to the character, quality, quantity, or cost of any work performed or to be performed, or materials furnished or to be furnished, in connection with the construction of any highway or related project approved by the Secretary of Transportation; or

Whoever knowingly makes any false statement or false representation as to material fact in any statement, certificate, or report submitted pursuant to provisions of the Federal-aid Roads Act approved July 1, 1916, (39 Stat. 355), as amended and supplemented;

Shall be fined under this title or imprisoned not more than 5 years or both."

IX. IMPLEMENTATION OF CLEAN AIR ACT AND FEDERAL WATER POLLUTION CONTROL ACT

This provision is applicable to all Federal-aid construction contracts and to all related subcontracts.

By submission of this bid/proposal or the execution of this contract, or subcontract, as appropriate, the bidder, proposer, Federal-aid construction contractor, or subcontractor, as appropriate, will be deemed to have stipulated as follows:

1. That any person who is or will be utilized in the performance of this contract is not prohibited from receiving an award due to a violation of Section 508 of the Clean Water Act or Section 306 of the Clean Air Act.

2. That the contractor agrees to include or cause to be included the requirements of paragraph (1) of this Section X in every subcontract, and further agrees to take such action as the contracting agency may direct as a means of enforcing such requirements.

X. CERTIFICATION REGARDING DEBARMENT, SUSPENSION, INELIGIBILITY AND VOLUNTARY EXCLUSION

This provision is applicable to all Federal-aid construction contracts, design-build contracts, subcontracts, lower-tier subcontracts, purchase orders, lease agreements, consultant contracts or any other covered transaction requiring FHWA approval or that is estimated to cost \$25,000 or more – as defined in 2 CFR Parts 180 and 1200.

1. Instructions for Certification – First Tier Participants:

a. By signing and submitting this proposal, the prospective first tier participant is providing the certification set out below.

b. The inability of a person to provide the certification set out below will not necessarily result in denial of participation in this covered transaction. The prospective first tier participant shall submit an explanation of why it cannot provide the certification set out below. The certification or explanation will be considered in connection with the department or agency's determination whether to enter into this transaction. However, failure of the prospective first tier participant to furnish a certification or an explanation shall disqualify such a person from participation in this transaction.

c. The certification in this clause is a material representation of fact upon which reliance was placed when the contracting agency determined to enter into this transaction. If it is later determined that the prospective participant knowingly rendered an erroneous certification, in addition to other remedies available to the Federal

Government, the contracting agency may terminate this transaction for cause of default.

d. The prospective first tier participant shall provide immediate written notice to the contracting agency to whom this proposal is submitted if any time the prospective first tier participant learns that its certification was erroneous when submitted or has become erroneous by reason of changed circumstances.

e. The terms "covered transaction," "debarred," "suspended," "ineligible," "participant," "person," "principal," and "voluntarily excluded," as used in this clause, are defined in 2 CFR Parts 180 and 1200. "First Tier Covered Transactions" refers to any covered transaction between a grantee or subgrantee of Federal funds and a participant (such as the prime or general contract). "Lower Tier Covered Transactions" refers to any covered transaction under a First Tier Covered Transaction (such as subcontracts). "First Tier Participant" refers to the participant who has entered into a covered transaction with a grantee or subgrantee of Federal funds (such as the prime or general contractor). "Lower Tier Participant" refers any participant who has entered into a covered transaction with a First Tier Participant or other Lower Tier Participants (such as subcontractors and suppliers).

f. The prospective first tier participant agrees by submitting this proposal that, should the proposed covered transaction be entered into, it shall not knowingly enter into any lower tier covered transaction with a person who is debarred, suspended, declared ineligible, or voluntarily excluded from participation in this covered transaction, unless authorized by the department or agency entering into this transaction.

g. The prospective first tier participant further agrees by submitting this proposal that it will include the clause titled "Certification Regarding Debarment, Suspension, Ineligibility and Voluntary Exclusion-Lower Tier Covered Transactions," provided by the department or contracting agency, entering into this covered transaction, without modification, in all lower tier covered transactions and in all solicitations for lower tier covered transactions exceeding the \$25,000 threshold.

h. A participant in a covered transaction may rely upon a certification of a prospective participant in a lower tier covered transaction that is not debarred, suspended, ineligible, or voluntarily excluded from the covered transaction, unless it knows that the certification is erroneous. A participant is responsible for ensuring that its principals are not suspended, debarred, or otherwise ineligible to participate in covered transactions. To verify the eligibility of its principals, as well as the eligibility of any lower tier prospective participants, each participant may, but is not required to, check the Excluded Parties List System website (<https://www.epls.gov/>), which is compiled by the General Services Administration.

i. Nothing contained in the foregoing shall be construed to require the establishment of a system of records in order to render in good faith the certification required by this clause. The knowledge and information of the prospective participant is not required to exceed that which is normally possessed

EXHIBIT 5 – SPECIAL PROVISIONS AND CONTRACT REQUIREMENTS

by a prudent person in the ordinary course of business dealings.

j. Except for transactions authorized under paragraph (f) of these instructions, if a participant in a covered transaction knowingly enters into a lower tier covered transaction with a person who is suspended, debarred, ineligible, or voluntarily excluded from participation in this transaction, in addition to other remedies available to the Federal Government, the department or agency may terminate this transaction for cause or default.

2. Certification Regarding Debarment, Suspension, Ineligibility and Voluntary Exclusion – First Tier Participants:

a. The prospective first tier participant certifies to the best of its knowledge and belief, that it and its principals:

(1) Are not presently debarred, suspended, proposed for debarment, declared ineligible, or voluntarily excluded from participating in covered transactions by any Federal department or agency;

(2) Have not within a three-year period preceding this proposal been convicted of or had a civil judgment rendered against them for commission of fraud or a criminal offense in connection with obtaining, attempting to obtain, or performing a public (Federal, State or local) transaction or contract under a public transaction; violation of Federal or State antitrust statutes or commission of embezzlement, theft, forgery, bribery, falsification or destruction of records, making false statements, or receiving stolen property;

(3) Are not presently indicted for or otherwise criminally or civilly charged by a governmental entity (Federal, State or local) with commission of any of the offenses enumerated in paragraph (a)(2) of this certification; and

(4) Have not within a three-year period preceding this application/proposal had one or more public transactions (Federal, State or local) terminated for cause or default.

b. Where the prospective participant is unable to certify to any of the statements in this certification, such prospective participant shall attach an explanation to this proposal.

2. Instructions for Certification - Lower Tier Participants:

(Applicable to all subcontracts, purchase orders and other lower tier transactions requiring prior FHWA approval or estimated to cost \$25,000 or more - 2 CFR Parts 180 and 1200)

a. By signing and submitting this proposal, the prospective lower tier is providing the certification set out below.

b. The certification in this clause is a material representation of fact upon which reliance was placed when this transaction was entered into. If it is later determined that the prospective lower tier participant knowingly rendered an erroneous certification, in addition to other remedies available to the Federal Government, the department, or agency with which this transaction originated may pursue available remedies, including suspension and/or debarment.

c. The prospective lower tier participant shall provide immediate written notice to the person to which this proposal is submitted if at any time the prospective lower tier participant learns that its certification was erroneous by reason of changed circumstances.

d. The terms "covered transaction," "debarred," "suspended," "ineligible," "participant," "person," "principal," and "voluntarily excluded," as used in this clause, are defined in 2 CFR Parts 180 and 1200. You may contact the person to which this proposal is submitted for assistance in obtaining a copy of those regulations.

"First Tier Covered Transactions" refers to any covered transaction between a grantee or subgrantee of Federal funds and a participant (such as the prime or general contract). "Lower Tier Covered Transactions" refers to any covered transaction under a First Tier Covered Transaction (such as subcontracts). "First Tier Participant" refers to the participant who has entered into a covered transaction with a grantee or subgrantee of Federal funds (such as the prime or general contractor). "Lower Tier Participant" refers any participant who has entered into a covered transaction with a First Tier Participant or other Lower Tier Participants (such as subcontractors and suppliers).

e. The prospective lower tier participant agrees by submitting this proposal that, should the proposed covered transaction be entered into, it shall not knowingly enter into any lower tier covered transaction with a person who is debarred, suspended, declared ineligible, or voluntarily excluded from participation in this covered transaction, unless authorized by the department or agency with which this transaction originated.

f. The prospective lower tier participant further agrees by submitting this proposal that it will include this clause titled "Certification Regarding Debarment, Suspension, Ineligibility and Voluntary Exclusion-Lower Tier Covered Transaction," without modification, in all lower tier covered transactions and in all solicitations for lower tier covered transactions exceeding the \$25,000 threshold.

g. A participant in a covered transaction may rely upon a certification of a prospective participant in a lower tier covered transaction that is not debarred, suspended, ineligible, or voluntarily excluded from the covered transaction, unless it knows that the certification is erroneous. A participant is responsible for ensuring that its principals are not suspended, debarred, or otherwise ineligible to participate in covered transactions. To verify the eligibility of its principals, as well as the eligibility of any lower tier prospective participants, each participant may, but is not required to, check the Excluded Parties List System website (<https://www.epls.gov/>), which is compiled by the General Services Administration.

h. Nothing contained in the foregoing shall be construed to require establishment of a system of records in order to render in good faith the certification required by this clause. The knowledge and information of participant is not required to exceed that which is normally possessed by a prudent person in the ordinary course of business dealings.

i. Except for transactions authorized under paragraph e of these instructions, if a participant in a covered transaction knowingly enters into a lower tier covered transaction with a person who is suspended, debarred, ineligible, or voluntarily excluded from participation in this transaction, in addition to other remedies available to the Federal Government, the department or agency with which this transaction originated may pursue available remedies, including suspension and/or debarment.

EXHIBIT 5 – SPECIAL PROVISIONS AND CONTRACT REQUIREMENTS

Certification Regarding Debarment, Suspension, Ineligibility and Voluntary Exclusion--Lower Tier Participants:

1. The prospective lower tier participant certifies, by submission of this proposal, that neither it nor its principals is presently debarred, suspended, proposed for debarment, declared ineligible, or voluntarily excluded from participating in covered transactions by any Federal department or agency.

2. Where the prospective lower tier participant is unable to certify to any of the statements in this certification, such prospective participant shall attach an explanation to this proposal.

* * * * *

XI. CERTIFICATION REGARDING USE OF CONTRACT FUNDS FOR LOBBYING

This provision is applicable to all Federal-aid construction contracts and to all related subcontracts which exceed \$100,000 (49 CFR 20).

1. The prospective participant certifies, by signing and submitting this bid or proposal, to the best of his or her knowledge and belief, that:

a. No Federal appropriated funds have been paid or will be paid, by or on behalf of the undersigned, to any person for influencing or attempting to influence an officer or employee of any Federal agency, a Member of Congress, an officer or employee of Congress, or an employee of a Member of Congress in connection with the awarding of any Federal contract, the making of any Federal grant, the making of any Federal loan, the entering into of any cooperative agreement, and the extension, continuation, renewal, amendment, or modification of any Federal contract, grant, loan, or cooperative agreement.

b. If any funds other than Federal appropriated funds have been paid or will be paid to any person for influencing or attempting to influence an officer or employee of any Federal agency, a Member of Congress, an officer or employee of Congress, or an employee of a Member of Congress in connection with this Federal contract, grant, loan, or cooperative agreement, the undersigned shall complete and submit Standard Form-LLL, "Disclosure Form to Report Lobbying," in accordance with its instructions.

2. This certification is a material representation of fact upon which reliance was placed when this transaction was made or entered into. Submission of this certification is a prerequisite for making or entering into this transaction imposed by 31 U.S.C. 1352. Any person who fails to file the required certification shall be subject to a civil penalty of not less than \$10,000 and not more than \$100,000 for each such failure.

3. The prospective participant also agrees by submitting its bid or proposal that the participant shall require that the language of this certification be included in all lower tier subcontracts, which exceed \$100,000 and that all such recipients shall certify and disclose accordingly.

ATTACHMENT A - EMPLOYMENT AND MATERIALS PREFERENCE FOR APPALACHIAN DEVELOPMENT HIGHWAY SYSTEM OR APPALACHIAN LOCAL ACCESS ROAD CONTRACTS

This provision is applicable to all Federal-aid projects funded under the Appalachian Regional Development Act of 1965.

1. During the performance of this contract, the contractor undertaking to do work which is, or reasonably may be, done as on-site work, shall give preference to qualified persons who regularly reside in the labor area as designated by the DOL wherein the contract work is situated, or the subregion, or the Appalachian counties of the State wherein the contract work is situated, except:

a. To the extent that qualified persons regularly residing in the area are not available.

b. For the reasonable needs of the contractor to employ supervisory or specially experienced personnel necessary to assure an efficient execution of the contract work.

c. For the obligation of the contractor to offer employment to present or former employees as the result of a lawful collective bargaining contract, provided that the number of nonresident persons employed under this subparagraph (1c) shall not exceed 20 percent of the total number of employees employed by the contractor on the contract work, except as provided in subparagraph (4) below.

2. The contractor shall place a job order with the State Employment Service indicating (a) the classifications of the laborers, mechanics and other employees required to perform the contract work, (b) the number of employees required in each classification, (c) the date on which the participant estimates such employees will be required, and (d) any other pertinent information required by the State Employment Service to complete the job order form. The job order may be placed with the State Employment Service in writing or by telephone. If during the course of the contract work, the information submitted by the contractor in the original job order is substantially modified, the participant shall promptly notify the State Employment Service.

3. The contractor shall give full consideration to all qualified job applicants referred to him by the State Employment Service. The contractor is not required to grant employment to any job applicants who, in his opinion, are not qualified to perform the classification of work required.

4. If, within one week following the placing of a job order by the contractor with the State Employment Service, the State Employment Service is unable to refer any qualified job applicants to the contractor, or less than the number requested, the State Employment Service will forward a certificate to the contractor indicating the unavailability of applicants. Such certificate shall be made a part of the contractor's permanent project records. Upon receipt of this certificate, the contractor may employ persons who do not normally reside in the labor area to fill positions covered by the certificate, notwithstanding the provisions of subparagraph (1c) above.

5. The provisions of 23 CFR 633.207(e) allow the contracting agency to provide a contractual preference for the use of mineral resource materials native to the Appalachian region.

STANDARD FEDERAL EQUAL EMPLOYMENT OPPORTUNITY CONSTRUCTION CONTRACT SPECIFICATIONS

NOTICE OF REQUIREMENT FOR AFFIRMATIVE ACTION TO ENSURE EQUAL EMPLOYMENT OPPORTUNITY (EXECUTIVE ORDER 11246)

1. The Offeror's or Bidders attention is called to the "Equal Opportunity Clause" and the "Standard Federal Equal Employment Opportunity Construction Contract Specifications" set forth herein.
2. The goals and timetables for minority and female participation expressed in percentage terms for the Contractor's aggregate work force in each trade on all construction work in the covered area are as follows:

Goals for Women Apply Nationwide

GOALS AND TIMETABLES

<i>Timetable</i>	<i>Goals (percent)</i>
From Apr. 1, 1976 until March 31, 1979----- --	3.1
From Apr. 1, 1979 until March 31, 1980----- --	5.1
From Apr. 1, 1980 until March 31, 1981----- --	6.9

Goals for Minority Participation

South Carolina

SMSA Counties:..... Greenville, Pickens, Spartanburg	16.0
Non-SMSA Counties:..... Abbeville, Anderson, Cherokee, Greenwood, Laurens, Oconee, Union	17.8
SMSA Counties:..... Lexington, Richland	23.4
Non-SMSA Counties..... Calhoun, Clarendon, Fairfield, Kershaw, Lee, Newberry, Orangeburg, Saluda, Sumter	32.0
Non-SMSA Counties..... Chesterfield, Darlington, Dillon, Florence, Georgetown, Horry, Marion, Marlboro, Williamsburg	33.0
SMSA Counties:..... Berkeley, Charleston, Dorchester	30.0
Non-SMSA Counties..... Colleton	30.7
Non-SMSA Counties..... Beaufort, Hampton, Jasper	29.8
Non-SMSA Counties..... Chester Lancaster York	15.7
Non-SMSA Counties..... Barnwell, Edgefield, McCormick, Allendale, Bamberg	32.8
SMSA Counties:..... Aiken	27.2

These goals are applicable to all the Contractor's construction work (whether or not it is Federal or federally assisted) performed in the covered area. If the Contractor performs construction work in a geographical area located outside of the covered area, it shall apply the goals established for such geographical areas where the work is actually performed. With regard to this second area, the Contractor is also subject to the goals for both its federally involved and nonfederally involved construction.

The Contractor's compliance with the Executive Order and the regulations in 41 CFR Part 60-4 Shall be based on its implementation of the Equal Opportunity Clause, specific affirmative action obligations required by the specifications set forth in 41 CFR 60-4.3(a) and its efforts to meet the goals established for the geographical area where the contract resulting from this solicitation is to be performed. The hours of minority and female employment and training must be substantially uniform throughout the length of the contract, and in each trade, and the Contractor shall make a good faith effort to employ minorities and women evenly on each of its projects. The transfer of minority or female employees of trainees from Contractor to Contractor or from project to project for the sole purpose of meeting the Contractor's goals shall be a violation of the contract, the Executive Order and the regulations in 41 CFR Part 60-4. Compliance with the goals will be measured against the total work hours performed.

3. The Contractor shall provide written notification to the Director of the Office of Federal Contract Compliance Programs within 10 working days of award of any construction subcontract in excess of \$10,000 at any tier for construction work under the contract resulting from this solicitation. The notification shall list the name, address and telephone number of the subcontractor, employer identification number, estimated dollar amount of the subcontract; estimated starting and completion dates of the subcontract; and the geographical area in which the contract is to be performed.
4. As used in this Notice and in the contract resulting from this solicitation, the "covered area" is (insert description of the geographical areas where the contract is to be performed giving the state, county, and city, if any). The "covered area is the SMSA County or Counties or Non-SMSA County or Counties in which the contract work is performed.

STANDARD FEDERAL EQUAL EMPLOYMENT OPPORTUNITY CONSTRUCTION CONTRACT SPECIFICATIONS (EXECUTIVE ORDER 11246)

1. As used in these specifications:
 - a. "Covered area" means the geographical area described in the solicitation from which this contract resulted;
 - b. "Director" means Director, Office of Federal Contract Compliance Programs, United States Department of Labor, or any person to whom the Director delegates authority;
 - c. "Employer identification number" means the Federal Social Security number used on the Employers Quarterly Federal Tax Return, U. S. Treasury Department Form 941.
 - d. "Minority" includes:
 - (i) Black (all persons having origins in any of the Black African racial groups not of Hispanic origin);
 - (ii) Hispanic (all persons of Mexican, Puerto Rican, Cuban, Central or South American or other Spanish Culture or origin regardless of race);
 - (iii) Asian or Pacific Islander (all persons having origins in any of the original peoples of the Far East, Southeast Asia, the Indian Subcontinent, or the Pacific Islands); and
 - (iv) American Indian or Alaskan Native (all persons having origins in any of the original peoples of North America and maintaining identifiable tribal

EXHIBIT 5 – SPECIAL PROVISIONS AND CONTRACT REQUIREMENTS

affiliations through membership and participation or community identification).

2. Whenever the Contractor, or any Subcontractor at any tier, subcontracts a portion of the work involving any construction trade, it shall physically include in each subcontract in excess of \$10,000 the provisions of these specifications and the Notice which contains the applicable goals for minority and female participation and which is set forth in the solicitations from which this contract resulted.
3. If the Contractor is participating (pursuant to 41 CFR 60-4.5) in a Hometown Plan approved by the U. S. Department of Labor in the covered area either individually or through an association, its affirmative action obligations on all work in the Plan area (including goals and timetables) shall be in accordance with that Plan for those trades which have unions participating in the Plan. Contractors must be able to demonstrate their participation in and compliance with the provisions of any such Hometown Plan. Each Contractor or Subcontractor participating in an approved Plan is individually required to comply with its obligations under the EEO clause, and to make a good faith effort to achieve each goal under the Plan in each trade in which it has employees. The overall good faith performance by other Contractors or Subcontractors toward a goal in an approved Plan does not excuse any covered Contractor's or Subcontractor's failure to take good faith efforts to achieve the Plan goals and timetables.
4. The Contractor shall implement the specific affirmative action standards provided in paragraphs 7a through p of these specifications. The goals set forth in the solicitation from which this contract resulted are expressed as percentages of the total hours of employment and training of minority and female utilization the Contractor should reasonably be able to achieve in which it has employees in each construction trade in which it has employees in the covered area. Covered construction contractors performing construction work in geographical areas where they do not have a Federal or federally assisted construction contract shall apply the minority and female goals established for the geographical area where the work is being performed. Goals are published periodically in the Federal Register in notices form and such notices may be obtained from any Office of Federal Contract Compliance Programs office or from Federal procurement contracting officers. The Contractor is expected to make substantially uniform progress toward its goals in each craft during the period specified.
5. Neither the provisions of any collective bargaining agreement, nor the failure by a union with whom the Contractor has a collective bargaining agreement to refer either minorities or women shall excuse the Contractor's obligations under these specifications, Executive Order 11246, or the regulations promulgated pursuant thereto.
6. In order for the non-working training hours of apprentices and trainees to be counted in meeting the goals, such apprentices and trainees must be employed by the Contractor during the training period, and the Contractor must have made a commitment to employ the apprentices and trainees at the completion of their training, subject to the availability of employment opportunities. Trainees must be trained pursuant to training programs approved by the U. S. Department of Labor.
7. The Contractor shall take specific affirmative actions to ensure equal employment opportunity. The evaluation of the Contractor's compliance with these specifications shall be based upon its effort to achieve maximum results from its actions. The Contractor shall document these efforts fully, and shall implement affirmative action steps at least as extensive as the following:
 - a. Ensure and maintain a working environment free of harassment, intimidation, and coercion at all sites, and in all facilities at which the Contractor's employees are assigned to work. The Contractor where possible, will assign two or more women to each construction project.

The Contractor shall specifically ensure that all foremen, superintendents and other on-site supervisory personnel are aware of and carry out the Contractor's obligation to maintain such a working environment, with specific attention to minority of female individuals working at such sites or in such facilities.

- b. Establish and maintain a current list of minority and female recruitment sources, provide written notification to minority recruitment sources and to community organizations when the Contractor or its unions have employment opportunities available and maintain a record of the organization's responses.
- c. Maintain a current file of the names, addresses and telephone numbers of each minority and female off-the-street applicant and minority or female referral from a union, a recruitment source or community organization and of what action was taken with respect to each individual. If such individual was sent to the union hiring hall for referral and was not referred back to the Contractor by the union or, if referred, not employed by the Contractor, this shall be documented in the file with the reason therefor, along with whatever additional actions the Contractor may taken.
- d. Provide immediate written notification to the Director when union or unions with which the Contractor has a collective bargaining agreement has not referred to the Contractor a minority person or woman sent by the Contractor, or when the Contractor has other information that the union referral process has impeded the Contractor's efforts to meet his obligations.
- e. Develop on-the-job training opportunities and/or participate in training programs for the area which expressly include minorities and women, including upgrading programs and apprenticeship and trainee programs relevant to the Contractor's employment needs, especially those programs funded by the Department of Labor. The Contractor shall provide notice of these programs to the sources compiled under 7b above.
- f. Disseminate the Contractor's EEO policy to unions and training programs and requesting their cooperation in assisting the Contractor in meeting its EEO obligations; by including it in any policy manual and collective bargaining agreement; by publicizing it in the company newspaper, annual report, etc.; by specific review of the policy with all management personnel and with all minority and female employees at least once a year; and by posting the company EEO policy on bulletin boards accessible to all employees at each location where construction work is performed.
- g. Review at least annually, the company's EEO policy and affirmative action obligations under these specifications with all employees having any responsibility for hiring, assignment, layoff, termination or other employment decisions including specific review of these items with on-site supervisory personnel such as Superintendents, General Foremen, etc., prior to the initialization of construction work at any job site. A written record shall be made and maintained identifying the time and place of these meetings, persons attending, subject matter discussed, and disposition of the subject matter.
- h. Disseminate the Contractor's EEO policy externally by including it in any advertising in the news media, specifically including minority and female news media, and providing written notification to and discussing the Contractor's EEO policy with other Contractors and Subcontractors with whom the Contractor does or anticipates doing business.
- i. Direct its recruitment efforts, both oral and written, to minority, female and community organizations, to schools with minority and female students and to minority and female recruitment and training organizations serving the Contractor's recruitment area and employment needs. Not

EXHIBIT 5 – SPECIAL PROVISIONS AND CONTRACT REQUIREMENTS

- later than one month prior to the date for the acceptance of applications for apprenticeship or other training by any recruitment source, the Contractor shall send written notification to organizations such as the above, describing the openings, screening procedures and tests to be used in the selection process.
- j. Encourage present minority and female employees to recruit other minority persons and women and where reasonable, provide after school, summer, and vacation employment to minority and female youth both on the site and in other areas of a Contractor's work force.
 - k. Validate all tests and other selection requirements where there is an obligation to do so under 41 CFR Part 60-3.
 - l. Conduct, at least annually, an inventory and evaluation at least of all minority and female personnel for promotional opportunities and encourage these employees to seek or to prepare for, through appropriate training, etc., such opportunities.
 - m. Ensure that all seniority practices, job classifications, work assignments and other personnel practices, do not have a discriminatory effect by continually monitoring all personnel and employment related activities to ensure that the EEO policy and the Contractor's obligations under these specifications are being carried out.
 - n. Ensure that all facilities and company activities are non-segregated except that separate or single-user toilet and necessary changing facilities shall be provided to assure privacy between the sexes.
 - o. Document and maintain a record of all solicitations of offers for subcontracts from minority and female construction contractors and suppliers, including circulation of solicitations to minority and female contractor associations and other business associations.
 - p. Conduct a review, at least annually of all supervisors' adherence to and performance under the Contractor's EEO policies and affirmative action obligations.
8. Contractors are encouraged to participate in voluntary associations which assist in fulfilling one or more of their affirmative action obligations (7a through p). The efforts of a contractor association joint contractor-union, contractor-community, or other similar group of which the Contractor is a member and participant, may be asserted as fulfilling any one or more of its obligations under 7a through p of these specifications provided that the contractor actively participates in the group, makes every effort to assure that the group has a positive impact on the employment of minorities and women in the industry, ensures that the concrete benefits of the program are reflected in the contractor's minority and female work force participation, makes a good faith effort to meet its individual goals and timetables, and can provide access to documentation which demonstrates the effectiveness of actions taken on behalf of the Contractor. The obligation to comply, however, is the Contractor's and failure of such a group to fulfill an obligation shall not be a defense for the Contractor's noncompliance.
 9. A single goal for minorities and a separate single goal for women have been established. The Contractor, however, is required to provide equal employment opportunity and take affirmative action for all minority groups, both male and female, and all women, both minority and non-minority. Consequently, the Contractor may be in violation of the Executive Order if a particular group is employed in a substantially disparate manner (for example, even though the Contractor may be in violation of the Executive Order if a specific minority group of women is underutilized).
 10. The Contractor shall not use the goals and timetables or affirmative action standards to discriminate against any person because of race, color, religion, sex, or national origin.
 11. The Contractor shall not enter into any Subcontract with any person or firm debarred from the Government contracts pursuant to the executive Order 11246.
 12. The Contractor shall carry out such sanctions and penalties for violation of these specifications and the Equal Opportunity Clause, including suspensions, termination and cancellation of the existing subcontracts as may be imposed or ordered pursuant to Executive Order 11246, as amended, and its implementing regulations, by the Office if the Federal Compliance Programs. Any Contractor who fails to carry out such sanctions and penalties shall be in violation of the specifications and Executive Order 11246, as amended.
 13. The Contractor, in fulfilling its obligations under these specifications, shall implement specific affirmative action steps, at least as extensive as those standards prescribed in paragraph 7 of these specifications, so as to achieve maximum results from its efforts to ensure equal employment opportunity. If the Contractor fails to comply with the requirements of the executive Order, the implementing regulations, or these specifications, the Director shall proceed in accordance with 41 CFR 60-4-8.
 14. The Contractor shall designate a responsible official to monitor all employment related activity to ensure that the company EEO policy is being carried out, to submit reports relating to the provisions hereof as may be required by the Government and to keep records. Records shall at least include for each employee the name, address, telephone numbers, construction trade, union affiliation if any employee identification number when assigned, social security number, race, sex status(e.g., Mechanic, apprentice, trainee, helper, or laborer), dates of changes in status, hours worked per week in the indicated trade, rate of pay, and location at which the work was performed. Records shall be maintained in an easily understandable and retrievable form; however, to the degree that the existing records satisfy this requirement, contractors shall not be required to maintain separate records.
 15. Nothing herein provided shall be construed as a limitation upon the application of other laws which establish different standards of compliance or upon the application of requirements for the hiring of local or other area residents(e.g. those under the Public Works Employment Act of 1977 and the Community Development Block Grant Program).

GENERAL DECISION NUMBER SC47

General Decision Number: SC170047 01/06/2017 SC47

Superseded General Decision Number: SC20160047

State: South Carolina

Construction Type: Highway

Counties: Allendale, Bamberg, Barnwell, Beaufort, Colleton, Georgetown, Hampton, Jasper, Newberry, Orangeburg and Williamsburg Counties in South Carolina.

DOES NOT INCLUDE SAVANNAH RIVER SITE IN ALLENDALE AND BARNWELL COUNTIES

HIGHWAY CONSTRUCTION PROJECTS (excluding tunnels, building structures in rest area projects & railroad construction; bascule, suspension & spandrel arch bridges designed for commercial navigation, bridges involving marine construction; and other major bridges).

Note: Under Executive Order (EO) 13658, an hourly minimum wage of \$10.20 for calendar year 2017 applies to all contracts subject to the Davis-Bacon Act for which the contract is awarded (and any solicitation was issued) on or after January 1, 2015. If this contract is covered by the EO, the contractor must pay all workers in any classification listed on this wage determination at least \$10.20 per hour (or the applicable wage rate listed on this wage determination, if it is higher) for all hours spent performing on the contract in calendar year 2017. The EO minimum wage rate will be adjusted annually. Additional information on contractor requirements and worker protections under the EO is available at www.dol.gov/whd/govcontracts.

Modification Number	Publication Date
0	01/06/2017

SUSC2011-038 09/15/2011

	Rates	Fringes
CARPENTER (Form Work Only).....	\$ 14.47	
CEMENT MASON/CONCRETE FINISHER...	\$ 14.11	
IRONWORKER, REINFORCING.....	\$ 15.64	
LABORER		
Asphalt, Includes Asphalt Distributor, Raker, Shoverler, and Spreader.....	\$ 10.96	

EXHIBIT 5 – SPECIAL PROVISIONS AND CONTRACT REQUIREMENTS

Colleton.....	\$ 10.16
Common or General	
Beaufort.....	\$ 10.15
Colleton.....	\$ 10.16
Georgetown, Hampton,	
Jasper.....	\$ 10.07
Newberry, Allendale,	
Bamberg, Barnwell.....	\$ 11.82
Orangeburg.....	\$ 12.63
Williamsburg.....	\$ 10.01
Luteman.....	\$ 11.71
Pipelayer.....	\$ 13.87
Traffic Control-Cone Setter	
Allendale, Bamber,	
Barnwell, Newberry,	
Orangeburg.....	\$ 12.98
Beaufort, Colleton,	
Georgetown, Hampton,	
Jasper, Williamsburg.....	\$ 12.84
Traffic Control-Flagger.....	\$ 11.68

POWER EQUIPMENT OPERATOR:

Backhoe/Excavator/Trackhoe	
Allendale, Bamberg,	
Barnwell, Newberry,	
Orangeburg.....	\$ 17.56
Beaufort.....	\$ 15.20
Colleton.....	\$ 17.78
Georgetown, Hampton,	
Jasper, Williamsburg.....	\$ 17.23
Bulldozer.....	\$ 20.12
Crane.....	\$ 16.62
Grader/Blade.....	\$ 16.62
Loader (Front End).....	\$ 15.51
Mechanic.....	\$ 18.22
Milling Machine.....	\$ 18.83
Paver	
Allendale, Bamberg,	
Barnwell, Newberry,	
Orangeburg, Williamsburg...	\$ 15.01
Beaufort.....	\$ 14.96
Colleton, Georgetown,	
Hampton, Jasper.....	\$ 13.67
Roller.....	\$ 12.76
Screed.....	\$ 13.01
Tractor.....	\$ 13.26

TRUCK DRIVER

Dump Truck.....	\$ 12.00
Lowboy Truck.....	\$ 14.43
Single Axle, Includes	
Pilot Car.....	\$ 12.04
Tractor Haul Truck.....	\$ 16.25

WELDERS - Receive rate prescribed for craft performing operation to which welding is incidental.

EXHIBIT 5 – SPECIAL PROVISIONS AND CONTRACT REQUIREMENTS

Note: Executive Order (EO) 13706, Establishing Paid Sick Leave for Federal Contractors applies to all contracts subject to the Davis-Bacon Act for which the contract is awarded (and any solicitation was issued) on or after January 1, 2017. If this contract is covered by the EO, the contractor must provide employees with 1 hour of paid sick leave for every 30 hours they work, up to 56 hours of paid sick leave each year. Employees must be permitted to use paid sick leave for their own illness, injury or other health-related needs, including preventive care; to assist a family member (or person who is like family to the employee) who is ill, injured, or has other health-related needs, including preventive care; or for reasons resulting from, or to assist a family member (or person who is like family to the employee) who is a victim of, domestic violence, sexual assault, or stalking. Additional information on contractor requirements and worker protections under the EO is available at www.dol.gov/whd/govcontracts.

Unlisted classifications needed for work not included within the scope of the classifications listed may be added after award only as provided in the labor standards contract clauses (29CFR 5.5 (a) (1) (ii)).

The body of each wage determination lists the classification and wage rates that have been found to be prevailing for the cited type(s) of construction in the area covered by the wage determination. The classifications are listed in alphabetical order of "identifiers" that indicate whether the particular rate is a union rate (current union negotiated rate for local), a survey rate (weighted average rate) or a union average rate (weighted union average rate).

Union Rate Identifiers

A four letter classification abbreviation identifier enclosed in dotted lines beginning with characters other than "SU" or "UAVG" denotes that the union classification and rate were prevailing for that classification in the survey. Example: PLUM0198-005 07/01/2014. PLUM is an abbreviation identifier of the union which prevailed in the survey for this classification, which in this example would be Plumbers. 0198 indicates the local union number or district council number where applicable, i.e., Plumbers Local 0198. The next number, 005 in the example, is an internal number used in processing the wage determination. 07/01/2014 is the effective date of the most current negotiated rate, which in this example is July 1, 2014.

Union prevailing wage rates are updated to reflect all rate changes in the collective bargaining agreement (CBA) governing

EXHIBIT 5 – SPECIAL PROVISIONS AND CONTRACT REQUIREMENTS

this classification and rate.

Survey Rate Identifiers

Classifications listed under the "SU" identifier indicate that no one rate prevailed for this classification in the survey and the published rate is derived by computing a weighted average rate based on all the rates reported in the survey for that classification. As this weighted average rate includes all rates reported in the survey, it may include both union and non-union rates. Example: SULA2012-007 5/13/2014. SU indicates the rates are survey rates based on a weighted average calculation of rates and are not majority rates. LA indicates the State of Louisiana. 2012 is the year of survey on which these classifications and rates are based. The next number, 007 in the example, is an internal number used in producing the wage determination. 5/13/2014 indicates the survey completion date for the classifications and rates under that identifier.

Survey wage rates are not updated and remain in effect until a new survey is conducted.

Union Average Rate Identifiers

Classification(s) listed under the UAVG identifier indicate that no single majority rate prevailed for those classifications; however, 100% of the data reported for the classifications was union data. EXAMPLE: UAVG-OH-0010 08/29/2014. UAVG indicates that the rate is a weighted union average rate. OH indicates the state. The next number, 0010 in the example, is an internal number used in producing the wage determination. 08/29/2014 indicates the survey completion date for the classifications and rates under that identifier.

A UAVG rate will be updated once a year, usually in January of each year, to reflect a weighted average of the current negotiated/CBA rate of the union locals from which the rate is based.

WAGE DETERMINATION APPEALS PROCESS

1.) Has there been an initial decision in the matter? This can be:

- * an existing published wage determination
- * a survey underlying a wage determination
- * a Wage and Hour Division letter setting forth a position on a wage determination matter
- * a conformance (additional classification and rate) ruling

On survey related matters, initial contact, including requests for summaries of surveys, should be with the Wage and Hour Regional Office for the area in which the survey was conducted

EXHIBIT 5 – SPECIAL PROVISIONS AND CONTRACT REQUIREMENTS

because those Regional Offices have responsibility for the Davis-Bacon survey program. If the response from this initial contact is not satisfactory, then the process described in 2.) and 3.) should be followed.

With regard to any other matter not yet ripe for the formal process described here, initial contact should be with the Branch of Construction Wage Determinations. Write to:

Branch of Construction Wage Determinations
Wage and Hour Division
U.S. Department of Labor
200 Constitution Avenue, N.W.
Washington, DC 20210

2.) If the answer to the question in 1.) is yes, then an interested party (those affected by the action) can request review and reconsideration from the Wage and Hour Administrator (See 29 CFR Part 1.8 and 29 CFR Part 7). Write to:

Wage and Hour Administrator
U.S. Department of Labor
200 Constitution Avenue, N.W.
Washington, DC 20210

The request should be accompanied by a full statement of the interested party's position and by any information (wage payment data, project description, area practice material, etc.) that the requestor considers relevant to the issue.

3.) If the decision of the Administrator is not favorable, an interested party may appeal directly to the Administrative Review Board (formerly the Wage Appeals Board). Write to:

Administrative Review Board
U.S. Department of Labor
200 Constitution Avenue, N.W.
Washington, DC 20210

4.) All decisions by the Administrative Review Board are final.

=====

END OF GENERAL DECISION